

| | | | |
|--|------------------------|-----------------------------|---|
| WAAS CH 40039 W26A | APP CRS 259° | Rwy Idg TDZE Apt Elev | 7702 6193 6204 |
|--|------------------------|-----------------------------|---|

RNAV (GPS) RWY 26

MORIARTY MUNI (ØEØ)

RNP APCH.

▼ For uncompensated Baro-VNAV systems, LNAV/VNAV NA below -27°C or above 54°C.
Circling Rwy 18 and 36 NA at night.

MISSED APPROACH: Climb to 9700 direct RIDSE and hold, continue climb-in-hold to 9700.

| | | |
|-------------------------|---|-------------------------------|
| AWOS-3 118.05 | ALBUQUERQUE CENTER 133.65 284.6 | CTAF 122.9 Ø |
|-------------------------|---|-------------------------------|

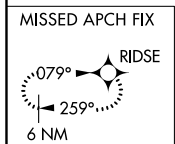
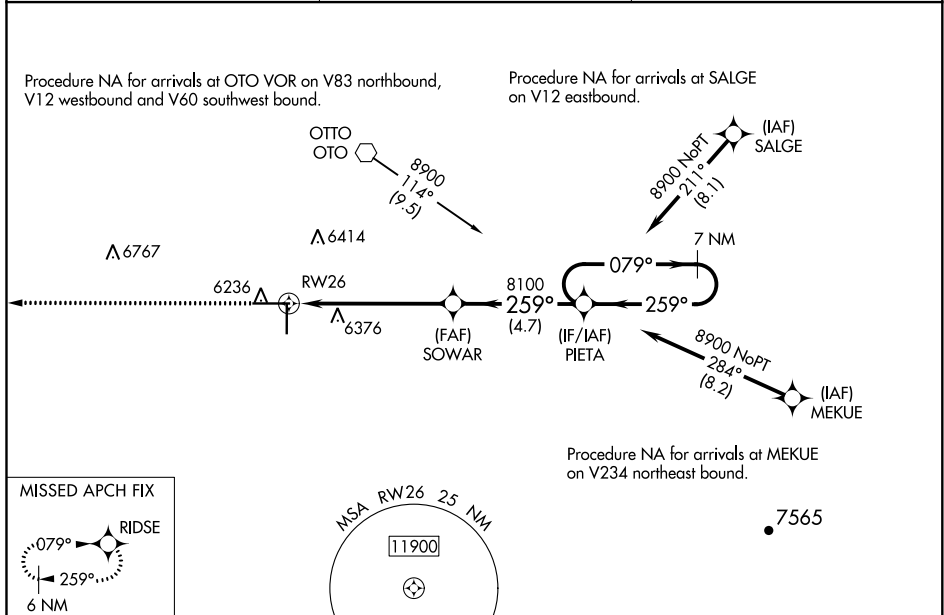

| | |
|------------------|------------------|
| ELEV 6204 | TDZE 6193 |
|------------------|------------------|

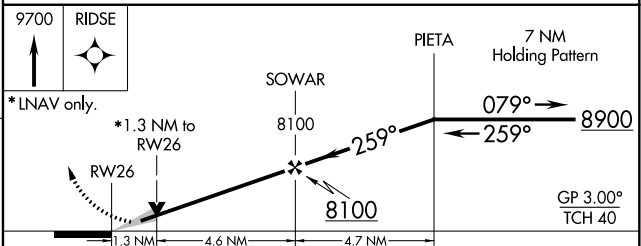
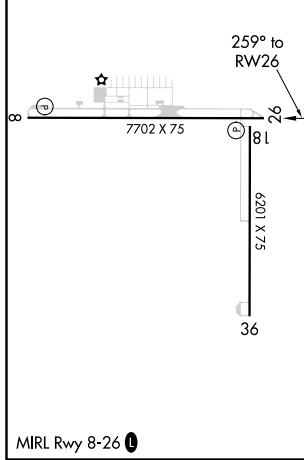

| CATEGORY | A | B | C | D |
|-------------------|-----------------------|-----------------------|-------------------------------|----|
| LPV DA | 6443-7/8 | 250 (300-7/8) | | NA |
| LNAV/VNAV DA | 6443-7/8 | 250 (300-7/8) | | NA |
| LNAV MDA | 6640-1 | 447 (500-1) | 6640-1 3/8 447 (500-1 3/8) | NA |
| C CIRCLING | 6660-1 456 (500-1) | 6680-1 476 (500-1) | 6780-1 1/2 576 (600-1 1/2) | NA |

SW-1, 09 SEP 2021 to 07 OCT 2021

SW-1, 09 SEP 2021 to 07 OCT 2021

| | | | |
|--|------------------------|-----------------------------|---|
| WAAS CH 86239 W08A | APP CRS 079° | Rwy Idg TDZE Apt Elev | 7702 6204 6204 |
|--|------------------------|-----------------------------|---|

RNAV (GPS) RWY 8

MORIARTY MUNI (E8)

| | | |
|-----------|--|---|
| RNP APCH. | <p>▼ For uncompensated Baro-VNAV systems, LNAV/VNAV NA below -27°C or above 54°C. Circling Rwy 18 and 36 NA at night. Rwy 8 helicopter visibility reduction below ¾ SM NA.</p> | MISSED APPROACH: Climb to 8700 direct PIETA and hold. |
|-----------|--|---|

| | | |
|-------------------------|---|------------------------|
| AWOS-3 118.05 | ALBUQUERQUE CENTER 133.65 284.6 | CTAF 122.9 0 |
|-------------------------|---|------------------------|

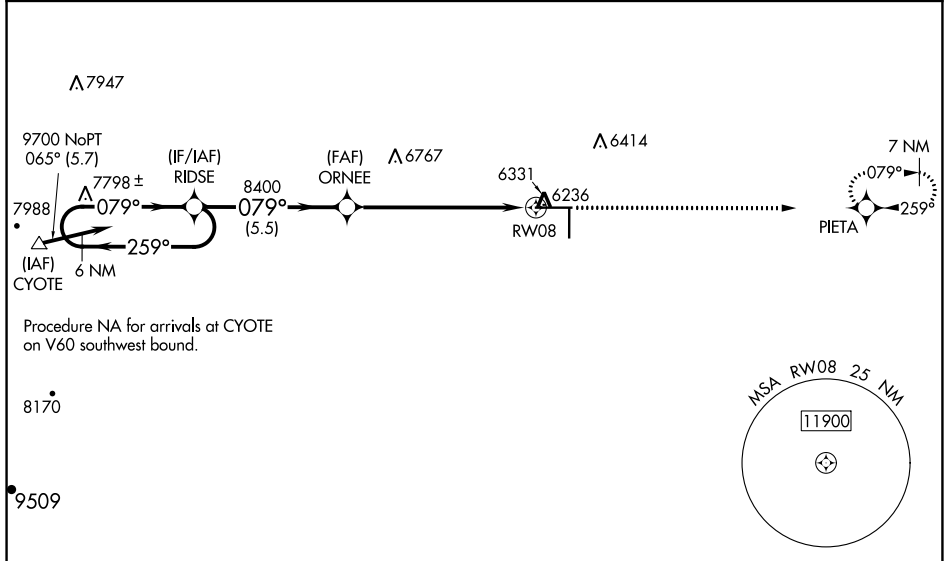

| | |
|-----------|-----------|
| ELEV 6204 | TDZE 6204 |
|-----------|-----------|

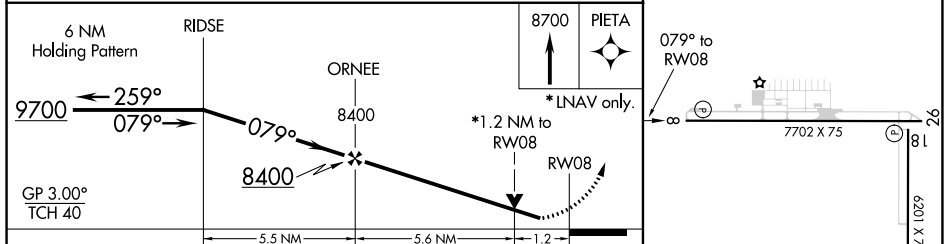

| CATEGORY | A | B | C | D |
|--------------|-----------------------|-----------------------|-------------------------|----|
| LPV DA | 6454-7/8 | 250 (300-7/8) | | NA |
| LNAV/VNAV DA | 6481-7/8 | 277 (300-7/8) | | NA |
| LNAV MDA | 6640-1 | 436 (500-1) | 6640-1¼ 436 (500-1¼) | NA |
| CIRCLING | 6660-1 456 (500-1) | 6680-1 476 (500-1) | 6780-1½ 576 (600-1½) | NA |

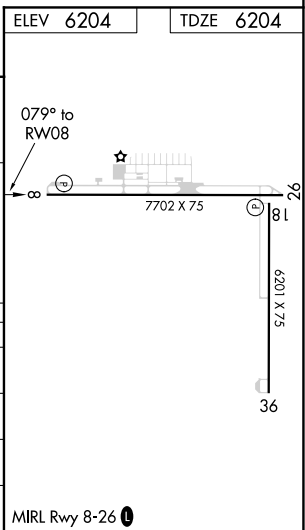

SW-1, 09 SEP 2021 to 07 OCT 2021

SW-1, 09 SEP 2021 to 07 OCT 2021



TAKEOFF MINIMUMS, (OBSTACLE) DEPARTURE PROCEDURES, AND DIVERSE VECTOR AREA (RADAR VECTORS)



21224

INSTRUMENT APPROACH PROCEDURE CHARTS



IFR TAKEOFF MINIMUMS AND (OBSTACLE) DEPARTURE PROCEDURES

Civil Airports and Selected Military Airports

ALL USERS: Airports that have Departure Procedures (DPs) designed specifically to assist pilots in avoiding obstacles during the climb to the minimum enroute altitude, and/or airports that have civil IFR takeoff minimums other than standard, are listed below. Takeoff Minimums and Departure Procedures apply to all runways unless otherwise specified. An entry may also be listed that contains only Takeoff Obstacle Notes. Altitudes, unless otherwise indicated, are minimum altitudes in MSL.

DPs specifically designed for obstacle avoidance are referred to as Obstacle Departure Procedures (ODPs) and are textually described below, or published separately as a graphic procedure. If the ODP is published as a graphic procedure, its name will be listed below, and it can be found in either this volume (civil), or the applicable military volume, as appropriate. Users will recognize graphic obstacle DPs by the term "(OBSTACLE)" included in the procedure title; e.g., TETON TWO (OBSTACLE). If not specifically assigned an ODP, SID, or RADAR vector as part of an IFR clearance, an ODP may be required to be flown for obstacle clearance, even though not specifically stated in the IFR clearance. When doing so in this manner, ATC should be informed when the ODP being used contains a specified route to be flown, restrictions before turning, and/or altitude restrictions.

Some ODPs, which are established solely for obstacle avoidance, require a climb in visual conditions to cross the airport, a fix, or a NAVAID in a specified direction, at or above a specified altitude. These procedures are called Visual Climb Over Airport (VCOA). To ensure safe and efficient operations, the pilot must verbally request approval from ATC to fly the VCOA when requesting their IFR clearance.

At some locations where an ODP has been established, a diverse vector area (DVA) may be created to allow RADAR vectors to be used in lieu of an ODP. DVA information will state that headings will be as assigned by ATC and climb gradients, when applicable, will be published immediately following the specified departure procedure.

Graphic DPs designed by ATC to standardize traffic flows, ensure aircraft separation and enhance capacity are referred to as "Standard Instrument Departures (SIDs)". SIDs also provide obstacle clearance and are published under the appropriate airport section. ATC clearance must be received prior to flying a SID.

CIVIL USERS NOTE: Title 14 Code of Federal Regulations Part 91 prescribes standard takeoff rules and establishes takeoff minimums for certain operators as follows: (1) For aircraft, other than helicopters, having two engines or less – one statute mile visibility. (2) For aircraft having more than two engines – one-half statute mile visibility. (3) For helicopters – one-half statute mile visibility. These standard minima apply in the absence of any different minima listed below.

MILITARY USERS NOTE: Civil (nonstandard) takeoff minima are published below. For military takeoff minima, refer to appropriate service directives.

AKRON, CO

COLORADO PLAINS RGNL (AKO)

TAKEOFF MINIMUMS AND (OBSTACLE) DEPARTURE PROCEDURES

ORIG 07MAY09 (09127) (FAA)

TAKEOFF OBSTACLE NOTES:

Rwy 11, rod on obstruction light on anemometer 314' from DER, 525' left of centerline, 26' AGL/4695' MSL. Lights on hangers 412' from DER, 301' left of centerline, 18' AGL/4687' MSL.

Rwy 29, vehicles on roadway beginning 971' from DER, 315' left of centerline, 15' AGL/4741' MSL.

Trees beginning 1651' from DER, 528' left of centerline, up to 100' AGL/4839' MSL.

ALAMOGORDO, NM

ALAMOGORDO-WHITE SANDS RGNL (ALM)

TAKEOFF MINIMUMS AND (OBSTACLE) DEPARTURE PROCEDURES

AMDT 2 22APR21 (21112) (FAA)

TAKEOFF MINIMUMS:

Rwys 17, 35, NA - Environmental.

Rwy 22, NA - Airspace.

DEPARTURE PROCEDURE:

Rwy 4, use CORONA DEPARTURE.

ALAMOSA, CO

SAN LUIS VALLEY RGNL/BERGMAN FLD (ALS)

TAKEOFF MINIMUMS AND (OBSTACLE) DEPARTURE PROCEDURES

AMDT 4C 05NOV20 (21168) (FAA)

DEPARTURE PROCEDURE:

Rwy 2, climbing right turn, thence...

Rwy 20, climbing left turn, thence...

...direct ALS VORTAC. Continue climb in ALS VORTAC holding pattern (SE, right turns, 301° inbound) to depart ALS VORTAC at airway MEA/MCA, all others climb to 16000.

TAKEOFF OBSTACLE NOTES:

Rwy 2, trees beginning 1070' to 2560' from DER, 197' to 702' left of centerline, 42' up to 72' AGL/7577' up to 7607' MSL



TAKEOFF MINIMUMS, (OBSTACLE) DEPARTURE PROCEDURES, AND DIVERSE VECTOR AREA (RADAR VECTORS)



21224

SW-1



TAKEOFF MINIMUMS, (OBSTACLE) DEPARTURE PROCEDURES, AND DIVERSE VECTOR AREA (RADAR VECTORS)



21224

ALBUQUERQUE, NM

ALBUQUERQUE INTL SUNPORT (ABQ)

TAKEOFF MINIMUMS AND (OBSTACLE) DEPARTURE PROCEDURES

AMDT 7 29MAY14 (14149) (FAA)

TAKEOFF MINIMUMS:

Rwy 8, std. w/min. climb of 515' per NM to 7800.

DEPARTURE PROCEDURE:

Rwys 3, 30, climbing left turn direct ABQ VORTAC. If required, continue climb in ABQ VORTAC holding pattern (hold W, left turns, 077° inbound) to cross ABQ VORTAC at or above MEA/MCA for route of flight.

Rwy 8, climbing right turn direct ABQ VORTAC. If required, continue climb in ABQ VORTAC holding pattern (hold W, left turns, 077° inbound) to cross ABQ VORTAC at or above MEA/MCA for route of flight. (Do not exceed 250 KTS until ABQ VORTAC).

Rwys 12, 21, climbing right turn direct ABQ VORTAC. If required, continue climb in ABQ VORTAC holding pattern (hold W, left turns, 077° inbound) to cross ABQ VORTAC at or above MEA/MCA for route of flight.

Rwy 26, climb direct ABQ VORTAC. If required, continue climb in ABQ VORTAC holding pattern. (Hold W, left turns, 077° inbound) to cross ABQ VORTAC at or above MEA/MCA for route of flight.

TAKEOFF OBSTACLE NOTES:

Rwy 3, tank 4961' from DER, 1708' left of centerline, 150' AGL/5466' MSL.

Water tower 4984' from DER, 1713' left of centerline, 156' AGL/5468' MSL.

Rwy 12, electrical equipment 36' from DER, 214' right of centerline, 16' AGL/5315' MSL.

Rwy 21, terrain beginning 159' from DER, 77' right of centerline, up to 5315' MSL.

Terrain beginning 199' from DER, 100' left of centerline, up to 5311' MSL.

Rwy 26, sign 38' from DER, 431' left of centerline, 14' AGL/5314' MSL.

Rwy 30, sign 48' from DER, 178' right of centerline, 15' AGL/5315' MSL.

Vehicle on road 229' from DER, 546' left of centerline, 19' AGL/5319' MSL.

Poles and tower beginning 876' from DER, 480' right of centerline, up to 93' AGL/5393' MSL.

DIVERSE VECTOR AREA (RADAR VECTORS)

ORIG 21JUL16 (16203) (FAA)

Rwy 3, 12, 21, 26, 30, Heading as assigned by ATC.

Rwy 8, Heading as assigned by ATC; requires minimum climb of 470' per NM to 7600. Do not exceed 240Kts until established on assigned heading.

DOUBLE EAGLE II (AEG)

TAKEOFF MINIMUMS AND (OBSTACLE) DEPARTURE PROCEDURES

AMDT 1 14FEB08 (08045) (FAA)

DEPARTURE PROCEDURE:

Rwy 4, climb heading 035° to 11700 before turning right, all others turn left on course.

Rwy 17, climb heading 169° to 9400 before turning left, all others turn right on course.

Rwy 22, climb heading 215° to 9100 before turning left, all others turn right on course.

Rwy 35, climb heading 349° to 11000 before turning right, all others turn left on course.

TAKEOFF OBSTACLE NOTES:

Rwy 17, antenna 64' from DER, 395' left of centerline, 8' AGL/ 5807' MSL.

Tree 3482' from DER, 1409' right of centerline, 100' AGL/ 5919' MSL.

Rwy 35, antenna 53' from DER, 405' right of centerline, 9' AGL/ 5808' MSL.

ANGEL FIRE, NM

ANGEL FIRE (AXX)

TAKEOFF MINIMUMS AND (OBSTACLE) DEPARTURE PROCEDURES

AMDT 1 31JUL08 (08213) (FAA)

TAKEOFF MINIMUMS:

Rwy 35, NA-obstacles.

DEPARTURE PROCEDURE:

Rwy 17, use ANEKE RNAV DEPARTURE.

ARTESIA, NM

ARTESIA MUNI (ATS)

TAKEOFF MINIMUMS AND (OBSTACLE) DEPARTURE PROCEDURES

AMDT 1A 15AUG19 (19227) (FAA)

TAKEOFF OBSTACLE NOTES:

Rwy 4, vegetation 88' from DER, 189' right of centerline, 7' AGL/3524' MSL.

Vehicles on road beginning 385' from DER, 407' right of centerline crossing runway extended centerline, up to 15' AGL/3534' MSL.

Rwy 22, aircraft on tarmac beginning at DER, 147' right of centerline, up to 42' AGL/3591' MSL.

Vehicles on road beginning 541' from DER, 638' left of centerline, crossing runway extended centerline, up to 15' AGL/3564' MSL.

Rwy 31, taxiing aircraft beginning at DER, 114' left of centerline, crossing runway extended centerline, up to 42' AGL/3551' MSL.

Vegetation 62' from DER, 493' left of centerline, 8' AGL/3542' MSL.

Towers beginning 2596' from DER, 1109' right of centerline, up to 88' AGL/3619' MSL.



TAKEOFF MINIMUMS, (OBSTACLE) DEPARTURE PROCEDURES, AND DIVERSE VECTOR AREA (RADAR VECTORS)



21224

SW-1



TAKEOFF MINIMUMS, (OBSTACLE) DEPARTURE PROCEDURES, AND DIVERSE VECTOR AREA (RADAR VECTORS)



21224

ASPEN, CO

ASPEN-PITKIN COUNTY/SARDY FLD (ASE)

TAKEOFF MINIMUMS AND (OBSTACLE) DEPARTURE PROCEDURES

AMDT 8 25SEP08 (21168) (FAA)

TAKEOFF MINIMUMS:

Rwy 15, NA-Terrain.

DEPARTURE PROCEDURE:

Rwy 33, use SARDD DEPARTURE.

BELEN, NM

BELEN RGNL (BRG)

TAKEOFF MINIMUMS AND (OBSTACLE) DEPARTURE PROCEDURES

AMDT 1B 13SEP18 (18256) (FAA)

TAKEOFF MINIMUMS:

Rwys 13, 31, NA - Environmental.

Rwy 3, std. w/min. climb of 350' per NM to 12000, or 3300-3 for VCOA.

Rwy 21, std. w/min. climb of 325' per NM to 11900, or 3300-3 for VCOA.

VCOA:

Rwys 3, 21, obtain ATC approval for VCOA when requesting IFR clearance. Climb in visual conditions to cross Belen Regional Airport at or above 8400 before proceeding on course.

TAKEOFF OBSTACLE NOTES:

Rwy 21, power poles beginning 1150' from DER, 275' left of centerline, up to 34' AGL/5236' MSL.

BUCKLEY AFB (KBKF),

AURORA, CO

TAKEOFF MINIMUMS AND (OBSTACLE) DEPARTURE PROCEDURES

13JAN11 (11013)

Diverse departure not authorized. Use published departure procedures for obstacle avoidance.

BUENA VISTA, CO

CENTRAL COLORADO RGNL (AEJ)

TAKEOFF MINIMUMS AND (OBSTACLE) DEPARTURE PROCEDURES

AMDT 1 04SEP03 (03247) (FAA)

TAKEOFF MINIMUMS:

Rwy 15, std. with a min. climb of 400' per NM to 8200 then 340' per NM to 15500.

Rwy 33, NA-due to terrain.

DEPARTURE PROCEDURE:

Rwy 15, use PUEBLO RNAV DEPARTURE.

Rwy 33, NA-due to terrain.

TAKEOFF OBSTACLE NOTES:

Rwy 15, tree 4468' from DER, 659' right of centerline, 60' AGL/8159' MSL.

BURLINGTON, CO

KIT CARSON COUNTY (ITR)

TAKEOFF MINIMUMS AND (OBSTACLE) DEPARTURE PROCEDURES

ORIG-A 01FEB18 (18032) (FAA)

TAKEOFF OBSTACLE NOTES:

Rwy 15, terrain beginning 32' from DER, 321' right of centerline, up to 4213' MSL.

CANNON AFB (KCVS),

CLOVIS, NM

TAKEOFF MINIMUMS AND (OBSTACLE) DEPARTURE PROCEDURES

AMDT 1 13SEP18 (18256)

Diverse departure authorized all runways.

TAKEOFF OBSTACLE NOTES:

Rwy 4, terrain 0' from DER, 500' left of cntrln, 4305' MSL.

Terrain 1061' from DER, 784' left of cntrln, 4329' MSL.

Terrain 1064' from DER, 772' left of cntrln, 4327' MSL.

Terrain 1187' from DER, 818' left of cntrln, 4327' MSL.

Terrain 267' from DER, 567' left of cntrln, 4304' MSL.

Rwy 13, terrain 0' from DER, 500' left of cntrln, 4280' MSL.

Terrain 276' from DER, 532' left of cntrln, 4281' MSL.

Rwy 22, terrain 0' from DER, 500' right of cntrln, 4283' MSL.

Terrain 537' from DER, 640' left of cntrln, 4295' MSL.

Terrain 554' from DER, 648' left of cntrln, 4292' MSL.

Rwy 31, terrain 0' from DER, 500' left of cntrln, 4294' MSL.

Terrain 190' from DER, 551' right of cntrln, 4309' MSL.

Terrain 277' from DER, 505' right of cntrln, 4311' MSL.



TAKEOFF MINIMUMS, (OBSTACLE) DEPARTURE PROCEDURES, AND DIVERSE VECTOR AREA (RADAR VECTORS)



21224

SW-1



TAKEOFF MINIMUMS, (OBSTACLE) DEPARTURE PROCEDURES, AND DIVERSE VECTOR AREA (RADAR VECTORS)



21224

CANON CITY, CO

FREMONT COUNTY (1V6)

TAKEOFF MINIMUMS AND (OBSTACLE) DEPARTURE PROCEDURES

AMDT 3 08NOV18 (18312) (FAA)

TAKEOFF MINIMUMS:

Rwys 17, 35, NA-ATC

DEPARTURE PROCEDURE:

Rwy 11, climb on heading 113° and PUB R-274 to PUB VORTAC before proceeding on course.

Rwy 29, climbing left turn to intercept PUB R-274 to PUB VORTAC before proceeding on course. Do not exceed 210 KIAS until established on PUB R-274 eastbound.

TAKEOFF OBSTACLE NOTES:

Rwy 11, tree and pole beginning 4' from DER, 20' left of centerline, up to 5383' MSL.

Pole 9' from DER, 19' right of centerline, 5383' MSL.

Tree 28' from DER, 213' left of centerline, 5384' MSL.

Rwy 29, fence, NAVAID beginning 8' from DER, 112' right of centerline, up to 17' AGL/5450' MSL.

Vehicles on road beginning 57' from DER, 290' left of centerline, up to 5450' MSL.

Vehicles on road 349' from DER, 541' right of centerline, 5454' MSL.

CARLSBAD, NM

CAVERN CITY AIR TRML (CNM)

TAKEOFF MINIMUMS AND (OBSTACLE) DEPARTURE PROCEDURES

ORIG 13JAN11 (21112) (FAA)

TAKEOFF MINIMUMS:

Rwy 21, std. w/min. climb of 206' per NM to 4300, or 1200-3 for climb in visual conditions.

Rwy 26, std. w/min. climb of 241' per NM to 4500, or 1300-3 for climb in visual conditions.

Rwy 32L, std. w/min. climb of 208' per NM to 4100.

DEPARTURE PROCEDURE:

Rwy 21, for climb in visual conditions, cross Cavern City Air Trml at or above 4300 before proceeding on course. **Rwys 26, 32L**, for climb in visual conditions, cross Cavern City Air Trml at or above 4400 before proceeding on course.

Rwy 32R, Climb heading 341° to 4100 before turning left.

TAKEOFF OBSTACLE NOTES:

Rwy 3, bushes beginning 65' from DER, 344' right of centerline, up to 6' AGL/3254' MSL.

Vehicle on road 388' from DER, 514' right of centerline, 15' AGL/3260' MSL.

Rwy 8, pole 604' from DER, 192' right of centerline, 26' AGL/3264' MSL.

Rwy 14L, bush 110' from DER, 216' left of centerline, 4' AGL/3246' MSL.

Localizer 164' from DER, 458' right of centerline, 8' AGL/3250' MSL.

Vehicle on road 398' from DER, 121' left of centerline, 15' AGL/3257' MSL.

Pole 398' from DER, 129' left of centerline, 20' AGL/3265' MSL.

Pole 520' from DER, 27' right of centerline, 24' AGL/3269' MSL.

Vehicle on road 720' from DER, 462' right of centerline, 15' AGL/3260' MSL.

Pole 837' from DER, 444' right of centerline, 26' AGL/3299' MSL.

Rwy 26, bush 107' from DER, 193' left of centerline, 6' AGL/3276' MSL.

Rwy 32R, fence 43' from DER, 333' left of centerline, 4' AGL/3273' MSL.

CLAYTON, NM

CLAYTON MUNI AIRPARK (CAO)

TAKEOFF MINIMUMS AND (OBSTACLE) DEPARTURE PROCEDURES

AMDT 1A 31JAN19 (19031) (FAA)

TAKEOFF MINIMUMS:

Rwy 2, std. w/min. climb of 220' per NM to 6700.

Rwy 30, std. w/min. climb of 257' per NM to 6700.

DEPARTURE PROCEDURE:

Rwy 20, climb heading 201° to 5500 before turning right.

Rwy 30, climb heading 301° to 6700 before turning left.

TAKEOFF OBSTACLE NOTES:

Rwy 2, sign 2' from DER, 201' left of centerline, 4' AGL/4971' MSL.

Fence 5' from DER, 418' left of centerline, 4' AGL/4972' MSL.

Fence 183' from DER, 513' left of centerline, 7' AGL/4975' MSL.

Rwy 12, vegetation 15' from DER, on centerline, 4948' MSL.

Rwy 20, general utility 9' from DER, 123' right of centerline, 4' AGL/4967' MSL.

Fence 33' from DER, 484' right of centerline, 6' AGL/4971' MSL.

Rwy 30, terrain 5' from DER, 242' left of centerline, 4968' MSL.

Electrical system, sign beginning 21' from DER, 123' left of centerline, up to 4' AGL/4971' MSL.

Vegetation 88' from DER, 172' right of centerline, 4969' MSL.

Vegetation beginning 102' from DER, 365' right of centerline, up to 4970' MSL.

Vegetation 181' from DER, 153' right of centerline, 4972' MSL.

Vegetation 183' from DER, 283' right of centerline, 4973' MSL.

Vegetation 194' from DER, 323' left of centerline, 4972' MSL.

09 SEP 2021 to 07 OCT 2021

09 SEP 2021 to 07 OCT 2021



TAKEOFF MINIMUMS, (OBSTACLE) DEPARTURE PROCEDURES, AND DIVERSE VECTOR AREA (RADAR VECTORS)



21224

SW-1



TAKEOFF MINIMUMS, (OBSTACLE) DEPARTURE PROCEDURES, AND DIVERSE VECTOR AREA (RADAR VECTORS)



21224

CLOVIS, NM

CLOVIS RGNL (CVN)

TAKEOFF MINIMUMS AND (OBSTACLE) DEPARTURE PROCEDURES

ORIG-A 19SEP13 (21112) (FAA)

TAKEOFF MINIMUMS:

Rwys 8, 26, NA - Environmental.**Rwy 4**, NA - Air traffic.

TAKEOFF OBSTACLE NOTES:

Rwy 12, pole 436' from DER, 500' left of centerline, 33' AGL/4217' MSL.**Rwy 22**, vehicle on road 267' from DER, 507' left of centerline, 15' AGL/4209' MSL.

Poles beginning 1323' from DER, 268' right of centerline, up to 31' AGL/4240' MSL.

COLORADO SPRINGS, CO

CITY OF COLORADO SPRINGS MUNI (COS)

TAKEOFF MINIMUMS AND (OBSTACLE) DEPARTURE PROCEDURES

AMDT 12A 14SEP17 (17257) (FAA)

TAKEOFF MINIMUMS:

Rwy 13, std. w/min. climb of 250' per NM to 6400, or alternatively with standard takeoff minimums and a normal 200' per NM climb gradient, takeoff must occur no later than 2000' prior to DER.**Rwy 31**, std. w/min. climb of 220' per NM to 7000.**Rwy 35L**, std. w/min. climb of 250' per NM to 7000.**Rwy 35R**, std. w/min. climb of 220' per NM to 7000.

DEPARTURE PROCEDURE:

Rwys 13, 17L/R, climbing left turn direct BRK VOR/DME, thence...**Rwy 31**, climb heading 307° to 7000, then climbing right turn direct BRK VOR/DME, thence...**Rwy 35R**, climb heading 352° to 7000, then climbing right turn direct BRK VOR/DME, thence...**Rwy 35L**, climbing right turn direct BRK VOR/DME, thence...

...continue climb in holding pattern (hold NW, LT, 159° inbound) to cross BRK VOR/DME at or above MEA/MCA for route of flight.

TAKEOFF OBSTACLE NOTES:

Rwy 13, RADAR antenna 4979' from DER, 1640' left of centerline, 107' AGL/6292' MSL.**Rwy 17L**, runway edge light (REIL) 25' from DER, 115' left and right of centerline, 3' AGL/6104' MSL.**Rwy 35L**, runway edge light (REIL) 39' from DER, 115' right of centerline, 2' AGL/6178' MSL.

Tree 5898' from DER, 1773' right of centerline, 50' AGL/6338' MSL.

DIVERSE VECTOR AREA (RADAR VECTORS)

AMDT 2 17AUG17 (17229) (FAA)

Rwy 13, heading as assigned by ATC; requires minimum climb of 250' per nm to 7400.**Rwy 17L**, heading as assigned by ATC.**Rwy 17R**, heading as assigned by ATC.**Rwy 31**, heading as assigned by ATC; requires minimum climb of 260' per nm to 7200.**Rwy 35L**, heading as assigned by ATC; requires minimum climb of 265' per nm to 7200.**Rwy 35R**, heading as assigned by ATC; requires minimum climb of 240' per nm to 7000.

CORTEZ, CO

CORTEZ MUNI (CEZ)

TAKEOFF MINIMUMS AND (OBSTACLE) DEPARTURE PROCEDURES

AMDT 3 08APR10 (10098) (FAA)

DEPARTURE PROCEDURE:

use LEDVE DEPARTURE.

CRAIG, CO

CRAIG-MOFFAT (CAG)

TAKEOFF MINIMUMS AND (OBSTACLE) DEPARTURE PROCEDURES

AMDT 4 05APR12 (12096) (FAA)

TAKEOFF MINIMUMS:

Rwy 7, std. w/min. climb of 510' per NM to 7200, or 2400-3 for climb in visual conditions.**Rwy 25**, std. w/min. climb of 350' per NM to 8200, or 2400-3 for climb in visual conditions.

DEPARTURE PROCEDURE:

Rwy 7, climb direct to CHE VOR/DME, or for climb in visual conditions, cross Craig-Moffat Airport at or above 8500 then proceed on CHE R-247 to CHE VOR/DME, thence**Rwy 25**, climbing right turn to intercept CHE VOR/DME radial 265 to CHE VOR/DME, or for climb in visual conditions, Cross Craig-Moffat Airport at or above 8500 then proceed on CHE R-247 to CHE VOR/DME, thence

.... Aircraft departing CHE VOR/DME on radials 214° CW 296° climb on course. All other aircraft climb in holding pattern (hold NW, right turns, 108° inbound) to cross CHE VOR/DME at or above; radials 297° CW 076° 11500, radials 077° CW 114° 10200, radials 115° CW 213° 11600. When executing VCOA, notify ATC prior to departure.

TAKEOFF OBSTACLE NOTES:

Rwy 7, vertical structure 108' from DER, 288' left of centerline, 18' AGL/6202' MSL.

Multiple trees beginning 450' from DER, 211' left and right of centerline, up to 100' AGL/6276' MSL.

Vehicles on road 104' from DER, 513' right to left of centerline, up to 15' AGL/6214' MSL.

CON'T



TAKEOFF MINIMUMS, (OBSTACLE) DEPARTURE PROCEDURES, AND DIVERSE VECTOR AREA (RADAR VECTORS)



21224

SW-1



TAKEOFF MINIMUMS, (OBSTACLE) DEPARTURE PROCEDURES, AND DIVERSE VECTOR AREA (RADAR VECTORS)



21224

CRAIG, CO (CON'T)

CRAIG-MOFFAT (CAG) (CON'T)

Rwy 25, vehicles on multiple roads beginning 5' from DER, 118' left and right of centerline, up to 15' AGL/6333' MSL.
Fence 14' from DER, 499' right of centerline, 5' AGL/6190' MSL.
Navigation aid 39' from DER, 93' right of centerline, 4' AGL/6189' MSL.
Tree 362' from DER, 435' right of centerline, 100' AGL/6203' MSL.
Multiple trees beginning 1457' from DER, 450' left of centerline, up to 100' AGL/6338' MSL.
Multiple poles 796' from DER, 625' left of centerline, up to 40' AGL/6285' MSL.
Terrain beginning 1941' from DER, 927' left of centerline, up to 6337' MSL.
Multiple buildings beginning 5509' from DER, 552' left of centerline, up to 15' AGL/6338' MSL.

DEL NORTE, CO

ASTRONAUT KENT ROMINGER (RCV)

TAKEOFF MINIMUMS AND (OBSTACLE) DEPARTURE PROCEDURES

ORIG 12OCT17 (17285) (FAA)

TAKEOFF MINIMUMS:

Rwy 3, 21, NA - turf/dirt runway.

DEPARTURE PROCEDURE:

Rwy 6, 24, use HOMME DEPARTURE.

DELTA, CO

BLAKE FLD (AJZ)

TAKEOFF MINIMUMS AND (OBSTACLE) DEPARTURE PROCEDURES

ORIG-A 20JUN19 (21112) (FAA)

TAKEOFF MINIMUMS:

Rwy 3, std. w/min. climb of 412 to 10200 or 3300-3 for climb in visual conditions.

Rwys 14, 32, NA - Environmental.

Rwy 21, std. w/min. climb of 452 to 10200 or 3300-3 for climb in visual conditions.

DEPARTURE PROCEDURE:

Rwy 3, DME required, climbing right turn heading 212° to intercept MTJ VOR/DME R-297 to BRICK/MTJ 23.44 DME. . .

Rwy 21, DME required, climbing heading 212° to intercept MTJ VOR/DME R-297 to BRICK/MTJ 23.44 DME. . .

. . . climb-in-hold (hold NW, RT, 117° inbound) to cross BRICK at or above 11300.

VCOA:

Obtain ATC approval for climb in visual conditions when requesting IFR clearance. DME required, climb in visual conditions

to cross Blake Fld airport at or above 8300, fly heading 248° and MTJ VOR/DME R-279 to BRICK/MTJ 23.44 DME, climb-in-

hold (hold NW, RT, 117° inbound) to cross BRICK at or above 11300.

TAKEOFF OBSTACLE NOTES:

Rwy 3, ground beginning 56' from DER, 103' left of centerline up to 5296' MSL.

Bush 69' from DER, 224' left of centerline 6' AGL/5197' MSL.

Bush 101' from DER, 103' left of centerline 5' AGL/5196' MSL.

Rwy 21, road beginning 6' from DER, 348' right of centerline 5124' MSL.

Bush 29' from DER, 253' right of centerline 2' AGL/5113' MSL.

DEMING, NM

DEMING MUNI (DMN)

TAKEOFF MINIMUMS AND (OBSTACLE) DEPARTURE PROCEDURES

AMDT 2A 13JAN11 (11013) (FAA)

TAKEOFF MINIMUMS:

Rwy 4, NA.

DEPARTURE PROCEDURE:

WESTBOUND:

Rwy 8, climbing left turn heading 214°;

Rwy 22, climbing right turn heading 302°;

Rwy 26, climbing right turn heading 275°; intercept DMN VORTAC R-258 then via V94 on course.

EASTBOUND:

Rwy 8, climb direct DMN VORTAC;

Rwys 22, 26, climbing right turn direct DMN VORTAC; then via V94 on course.

NORTHBOUND:

Rwy 8, climb direct DMN VORTAC;

Rwys 22, 26, climbing right turn direct DMN VORTAC; then via V110 on course.

TAKEOFF OBSTACLE NOTES:

Rwy 22, multiple trees and pole beginning 991' from DER, 139' right of centerline, up to 100' AGL/4380' MSL.

Rwy 26, multiple trees beginning 35' from DER, 88' right of centerline, up to 100' AGL/4365' MSL.

Multiple trees beginning 5' from DER, 37' left of centerline, up to 100' AGL/4355' MSL.

09 SEP 2021 to 07 OCT 2021

09 SEP 2021 to 07 OCT 2021



TAKEOFF MINIMUMS, (OBSTACLE) DEPARTURE PROCEDURES, AND DIVERSE VECTOR AREA (RADAR VECTORS)



21224

SW-1



L7

TAKEOFF MINIMUMS, (OBSTACLE) DEPARTURE PROCEDURES, AND DIVERSE VECTOR AREA (RADAR VECTORS)



21224

DENVER, CO

CENTENNIAL (APA)

TAKEOFF MINIMUMS AND (OBSTACLE) DEPARTURE PROCEDURES

AMDT 5A 25FEB21 (21056) (FAA)

TAKEOFF MINIMUMS:

Rwy 17L, std. w/ min. climb of 257' per NM to 6800.

Rwy 17R, std. w/ min. climb of 372' per NM to 6800.

DEPARTURE PROCEDURE:

Rwy 10, when departing on courses between 333° CW to 162° from DER climb on heading 103° to 6600 before turning right. All other courses, climbing left turn to intercept DEN VOR/DME R-194 to DEN VOR/DME, thence...

Rwys 17L/R, climb on a heading between 350° CW to 162° from DER. All other courses: climbing left turn to intercept DEN VOR/DME R-199 to DEN VOR/DME, thence...

Rwy 28, climb on a heading between 333° CW to 103° from DER. All other courses: climbing right turn to intercept DEN VOR/DME R-210 to DEN VOR/DME, thence...

Rwys 35L/R, climb on a heading between 333° CW to 162° from DER. All other courses: climb on heading 350° to intercept DEN VOR/DME R-211 to DEN VOR/DME, thence...

...climb in DEN VOR/DME holding pattern (hold south, right turns, 343° inbound) to 16500 before proceeding on course.

TAKEOFF OBSTACLE NOTES:

Rwy 10, vehicle on road 196' from DER, 408' left of centerline, 5799' MSL.

Vehicle on road 283' from DER, 402' left of centerline, 5804' MSL.

Vehicle on road 389' from DER, 396' left of centerline, 5809' MSL.

Vehicle on road 483' from DER, 618' right of centerline, 5815' MSL.

Vehicle on road 521' from DER, 393' left of centerline, 5815' MSL.

Vehicle on road 611' from DER, 569' right of centerline, 5817' MSL.

Vehicle on road 644' from DER, 401' left of centerline, 5818' MSL.

Vehicle on road 719' from DER, 528' right of centerline, 5818' MSL.

Vehicle on road 781' from DER, 425' left of centerline, 5823' MSL.

Tree, vehicle on road beginning 835' from DER, 458' right of centerline, up to 20' AGL/5828' MSL.

Vehicle on road 927' from DER, 464' left of centerline, 5827' MSL.

Terrain 958' from DER, 624' right of centerline, 5835' MSL.

Terrain, vehicle on road beginning 1013' from DER, 254' right of centerline, up to 5836' MSL.

Terrain, vehicle on road beginning 1113' from DER, 119' right of centerline, up to 5839' MSL.

Vehicle on road beginning 1138' from DER, 535' left of centerline, up to 5833' MSL.

Fence, vehicle on road, terrain beginning 1210' from DER, 3' right of centerline, up to 5841' MSL.

Vehicle on road beginning 1237' from DER, 31' left of centerline, up to 5834' MSL.

Terrain beginning 1282' from DER, 229' right of centerline, up to 5843' MSL.

Building, vehicle on road, pole beginning 1384' from DER, 71' left of centerline, up to 33' AGL/5854' MSL.

Pole, vehicle on road, terrain beginning 1470' from DER, 204' right of centerline, up to 5862' MSL.

Building, pole, vehicle on road, fence beginning 1562' from DER, 119' right of centerline, up to 40' AGL/5877' MSL.

Building, fence, pole, vertical structure beginning 1600' from DER, 229' right of centerline, up to 41' AGL/5879' MSL.

Building, tree beginning 1680' from DER, 306' right of centerline, up to 46' AGL/5882' MSL.

Building, fence, vehicle on road, pole, tree, terrain beginning 1685' from DER, 31' right of centerline, up to 5885' MSL.

Building, pole, terrain, vehicle on road beginning 2056' from DER, 34' right of centerline, up to 5889' MSL.

Building, pole beginning 2270' from DER, 662' right of centerline, up to 38' AGL/5892' MSL.

Rwy 17L, lighting 10' from DER, 9' right of centerline, 2' AGL/5886' MSL.

Pole 1755' from DER, 882' left of centerline, 31' AGL/5929' MSL.

Tree 2533' from DER, 342' left of centerline, 26' AGL/5949' MSL.

Tree 2579' from DER, 342' left of centerline, 27' AGL/5950' MSL.

Tree 2867' from DER, 455' right of centerline, 44' AGL/5959' MSL.

Tree 2973' from DER, 1211' right of centerline, 35' AGL/5963' MSL.

Tree 2974' from DER, 948' right of centerline, 42' AGL/5964' MSL.

Trees beginning 2997' from DER, 748' right of centerline, up to 50' AGL/5967' MSL.

Tree, lighting beginning 3025' from DER, 769' right of centerline, up to 56' AGL/5970' MSL.

Tree 3309' from DER, 747' left of centerline, 35' AGL/5970' MSL.

Tree 3344' from DER, 756' left of centerline, 36' AGL/5974' MSL.

Trees beginning 3444' from DER, 1225' right of centerline, up to 50' AGL/5981' MSL.

Building beginning 3849' from DER, 1479' left of centerline, up to 59' AGL/5988' MSL.

Tree 4767' from DER, 893' right of centerline, 49' AGL/6007' MSL.

Rwy 17R, terrain 9' from DER, 96' left of centerline, 5869' MSL.

Terrain 10' from DER, 273' right of centerline, 5872' MSL.

Vehicle on road, terrain beginning 75' from DER, 302' right of centerline, up to 5885' MSL.

General utility 103' from DER, 253' left of centerline, 7' AGL/5875' MSL.

Wind indicator, terrain beginning 118' from DER, 443' left of centerline, up to 5883' MSL.

Vehicle on road, terrain beginning 190' from DER, 353' right of centerline, up to 5887' MSL.

Pole, fence, terrain beginning 525' from DER, 196' right of centerline, up to 5918' MSL.

Pole 2190' from DER, 1029' right of centerline, 31' AGL/5928' MSL.

Pole 2289' from DER, 863' right of centerline, 30' AGL/5935' MSL.

Pole beginning 2361' from DER, 255' right of centerline, up to 32' AGL/5942' MSL.

Pole 2738' from DER, 1069' right of centerline, 42' AGL/5947' MSL.

Pole 2824' from DER, 904' right of centerline, 43' AGL/5948' MSL.

Pole 3108' from DER, 1151' right of centerline, 27' AGL/5949' MSL.

Tree 3163' from DER, 568' right of centerline, 66' AGL/5975' MSL.

Building 3226' from DER, 888' right of centerline, 73' AGL/5996' MSL.

CON'T

09 SEP 2021 to 07 OCT 2021

09 SEP 2021 to 07 OCT 2021



TAKEOFF MINIMUMS, (OBSTACLE) DEPARTURE PROCEDURES, AND DIVERSE VECTOR AREA (RADAR VECTORS)



21224

L7

SW-1



TAKEOFF MINIMUMS, (OBSTACLE) DEPARTURE PROCEDURES, AND DIVERSE VECTOR AREA (RADAR VECTORS)



21224

DENVER, CO (CON'T)

CENTENNIAL (APA) (CON'T)

Rwy 17R (CON'T) building beginning 3261' from DER, 820' right of centerline, up to 87' AGL/6010' MSL.

Building, tree, pole beginning 3281' from DER, 492' right of centerline, up to 88' AGL/6021' MSL.

Building beginning 5084' from DER, 1038' right of centerline, up to 79' AGL/6023' MSL.

Building 1 NM from DER, 1861' right of centerline, 64' AGL/6030' MSL.

Rwy 28, building 57' from DER, 495' right of centerline, 34' AGL/5858' MSL.

Pole, wind indicator, terrain beginning 99' from DER, 183' left of centerline, up to 5832' MSL.

Terrain 473' from DER, 578' left of centerline, 5836' MSL.

Rwy 35L, terrain 36' from DER, 163' right of centerline, 5805' MSL.

Trees beginning 158' from DER, 448' left of centerline, up to 35' AGL/5820' MSL.

Rwy 35R, lighting 8' from DER, 30' right of centerline, 2' AGL/5795' MSL.

Lighting 8' from DER, 30' left of centerline, 2' AGL/5794' MSL

DIVERSE VECTOR AREA (RADAR VECTORS)

ORIG 30JAN20 (20030) (FAA)

Rwy 10, headings as assigned by ATC; requires min. climb gradient of 203' per NM to 6800.

Rwy 17L, headings as assigned by ATC; requires min. climb gradient of 287' per NM to 8000.

Rwy 17R, headings as assigned by ATC; requires min. climb gradient of 372' per NM to 7400.

Rwys 28, 35L, 35R, headings as assigned by ATC.

COLORADO AIR AND SPACE PORT (CFO)

TAKEOFF MINIMUMS AND (OBSTACLE) DEPARTURE PROCEDURES

AMDT 3A 30JAN20 (20030) (FAA)

DEPARTURE PROCEDURE:

Rwy 8, climb on a heading between 312° CW to 228° from DER, all other courses climbing left turn direct DEN VOR/DME. Continue climb in DEN VOR/DME holding pattern (hold south, right turn, 343° inbound) to 16500 before proceeding on course.

Rwy 17, climb on a heading between 352° CW to 229° from DER, all other courses climbing right turn direct DEN VOR/DME. Continue climb in DEN VOR/DME holding pattern (hold south, right turn, 343° inbound) to 16500 before proceeding on course.

Rwy 26, climb on a heading between 315° CW to 083° or between 226° CCW to 083° from DER, all other courses climbing right turn direct DEN VOR/DME. Continue climb in DEN VOR/DME holding pattern (hold south, right turn, 343° inbound) to 16500 before proceeding on course.

Rwy 35, climb on a heading between 313° CW to 172° from DER, all other courses climbing left turn direct DEN VOR/DME. Continue climb in DEN VOR/DME holding pattern (hold south, right turn, 343° inbound) to 16500 before proceeding on course.

TAKEOFF OBSTACLE NOTES:

Rwy 17, pole 3618' from DER, 516' left of centerline, 43' AGL/5603' MSL.

Rwy 28, trees beginning 98' from DER, 456' right of centerline, up to 50' AGL/5489' MSL.

DENVER INTL (DEN)

TAKEOFF MINIMUMS AND (OBSTACLE) DEPARTURE PROCEDURES

AMDT 3 15NOV12 (12320) (FAA)

DEPARTURE PROCEDURE:

Rwy 7, climb on a heading between 315° CW to 218° from DER. All other courses: climbing right turn, thence ...

Rwy 8, climb on a heading between 310° CW to 220° from DER. All other courses: climbing right turn, thence ...

Rwys 16L, 16R, climb on a heading between 213° CCW to 353° from DER. All other courses: climbing left turn, thence...

Rwys 17L, 17R, climb on a heading between 222° CCW to 353° from DER. All other courses: climbing right turn, thence ...

Rwy 25, climb on a heading between 317° CW to 083° or 206° CCW to 083° from DER. All other courses: climbing left turn, thence ...

Rwy 26, climb on a heading between 313° CW to 083° or 219° CCW to 083° from DER. All other courses: climbing left turn, thence ...

Rwys 34L, 34R, climb on a heading between 313° CW to 172° from DER. All other courses: climbing right turn, thence ...

Rwys 35L, 35R, climb on a heading between 313° CW to 172° from DER. All other courses: climbing right turn, thence ...

... direct DEN VOR/DME, climb in DEN VOR/DME holding pattern (hold South, right turns, 343° inbound) to 16500 before proceeding on course.

TAKEOFF OBSTACLE NOTES:

Rwy 7, sign 21' from DER, 337' left of centerline, 5' AGL/5357' MSL.

Rwy 16L, multiple signs beginning 126' from DER, 490' left of centerline, up to 7' AGL/5359' MSL.

Communication tower 4749' from DER, 1358' left of centerline, 107' AGL/5478' MSL.

Rwy 25, sign 48' from DER, 450' right of centerline, 6' AGL/5354' MSL.

Rwy 26, sign 50' from DER, 339' left of centerline, 5' AGL/5356' MSL.

DIVERSE VECTOR AREA (RADAR VECTORS)

ORIG 26MAR20 (20086) (FAA)

Rwys 7, 8, 16L, 16R, 17L, 17R, 25, 26, 34L, 34R, 35L, 35R, heading as assigned by ATC.

09 SEP 2021 to 07 OCT 2021

09 SEP 2021 to 07 OCT 2021



TAKEOFF MINIMUMS, (OBSTACLE) DEPARTURE PROCEDURES, AND DIVERSE VECTOR AREA (RADAR VECTORS)



21224

SW-1



TAKEOFF MINIMUMS, (OBSTACLE) DEPARTURE PROCEDURES, AND DIVERSE VECTOR AREA (RADAR VECTORS)



21224

DENVER, CO (CON'T)

ROCKY MOUNTAIN METRO (BJC)

TAKEOFF MINIMUMS AND (OBSTACLE) DEPARTURE PROCEDURES

AMDT 7 26MAR20 (21168) (FAA)

DEPARTURE PROCEDURE:

Rwy 3, climb on a heading between 350° CW to 160° from DER. All other courses, climbing right turn heading 147° to intercept DEN VOR/DME R-284 to DEN VOR/DME, thence...

Rwys 12L/R, climb on a heading between 160° CCW to 350° from DER. All other courses, climb heading 115° to intercept DEN VOR/DME R-275 to DEN VOR/DME, thence...

Rwy 21, climb on a heading between 160° CCW to 026° from DER. All other courses, climbing left turn heading 044° to intercept DEN VOR/DME R-272 to DEN VOR/DME, thence...

Rwy 30R, climb on a heading between 350° CW to 113° from DER. All other courses, climbing right turn heading 142° to intercept DEN VOR/DME R-280 to DEN VOR/DME, thence...

Rwy 30L, climb on a heading between 350° CW to 113° from DER. All other courses, climbing right turn heading 142° to intercept DEN VOR/DME R-279 to DEN VOR/DME, thence...

...climb in DEN VOR/DME holding pattern (hold south, right turn, 343° inbound) to 16500 before proceeding on course.

TAKEOFF OBSTACLE NOTES:

Rwy 3, pole 431' from DER, 369' right of centerline, 49' AGL/5622' MSL.

Rwy 12L, multiple poles beginning 10' from DER, 395' left of centerline, up to 2' AGL/5567' MSL.

Rwy 12R, multiple poles and lighting beginning 8' from DER, 52' right of centerline, up to 2' AGL/5596' MSL.

Rwy 21, wind indicator 117' from DER, 209' left of centerline, 10' AGL/5622' MSL.

Rwy 30L, lighting 40' from DER, 76' right of centerline, 2' AGL/5676' MSL.

Lighting 40' from DER, 76' left of centerline, 2' AGL/5676' MSL.

Building 42' from DER, 499' left of centerline, 28' AGL/5703' MSL.

Building, vehicles on road, terrain and fence beginning 245' from DER, 147' left of centerline, up to 33' AGL/5708' MSL.

Fence, terrain and pole beginning 993' from DER, 92' left of centerline, up to 19' AGL/5734' MSL.

Pole, vehicle on road, tree and terrain beginning 1413' from DER, 715' left of centerline, up to 5736' MSL.

Tree and vehicle on road beginning 2761' from DER, 1094' left of centerline, up to 32' AGL/5754' MSL.

Rwy 30R, pole 10' from DER, 60' left of centerline, 2' AGL/5661' MSL.

Pole 11' from DER, 245' right of centerline, 2' AGL/5661' MSL.

Lighting 39' from DER, 126' right of centerline, 2' AGL/5662' MSL.

Pole 154' from DER, 496' left of centerline, 2' AGL/5667' MSL.

Pole 1606' from DER, 917' left of centerline, 44' AGL/5702' MSL.

DIVERSE VECTOR AREA (RADAR VECTORS)

AMDT 1 10NOV16 (16315) (FAA)

Rwys 3, 12L/R, 21, 30 L/R, heading as assigned by ATC.

DURANGO, CO

DURANGO-LA PLATA COUNTY (DRO)

TAKEOFF MINIMUMS AND (OBSTACLE) DEPARTURE PROCEDURES

AMDT 6A 15JAN09 (09015) (FAA)

TAKEOFF MINIMUMS:

Rwy 3, std. w/a min. climb of 215' per NM to 7600, or 1700-3 for climb in visual conditions.

DEPARTURE PROCEDURE:

Rwy 3, climbing right turn to 9000 heading 160° and DRO VOR/DME R-125 to RESER INT, or for climb in visual conditions: Cross Durango-La Plata County Airport Southeast bound at or above 8200 MSL, then proceed on DRO VOR/DME R-125 to RESER INT.

Rwy 21, climbing right turn to 9500 heading 280° and DRO VOR/DME R-235 to MARKE INT.

TAKEOFF OBSTACLE NOTES:

Rwy 3, trees beginning 1223' from DER, 794' left of centerline, up to 42' AGL/6741' MSL.

Trees beginning 488' from DER, 431' right of centerline, up to 42' AGL/6698' MSL.

Vehicles on road beginning 8' from DER, right and left of centerline, up to 15' AGL/6706' MSL.

EAGLE, CO

EAGLE COUNTY RGNL (EGE)

TAKEOFF MINIMUMS AND (OBSTACLE) DEPARTURE PROCEDURES

AMDT 8 12DEC13 (13346) (FAA)

TAKEOFF MINIMUMS:

Rwys 7, 25, 4200-3 for climb in visual conditions.

DEPARTURE PROCEDURE:

For climb in visual conditions cross Eagle County RGNL airport northeast bound at or above 10600 MSL then proceed on RLG R-212 to RLG VOR/DME. When executing VCOA, notify ATC prior to departure.

TAKEOFF OBSTACLE NOTES:

Rwy 7, runway lights 10' from DER, 33' right and left of centerline, 1' AGL/6549' MSL.

Vehicle on roadway 243' from DER, 28' right of centerline, 15' AGL/6562' MSL.

Tree 5041' from DER, 1689' right of centerline, up to 55' AGL/6695' MSL.

Rwy 25, runway lights 10' from DER, 55' right and left of centerline, up to 2' AGL/6462' MSL.



TAKEOFF MINIMUMS, (OBSTACLE) DEPARTURE PROCEDURES, AND DIVERSE VECTOR AREA (RADAR VECTORS)



21224

SW-1



TAKEOFF MINIMUMS, (OBSTACLE) DEPARTURE PROCEDURES, AND DIVERSE VECTOR AREA (RADAR VECTORS)



21224

ERIE, CO

ERIE MUNI (EIK)

TAKEOFF MINIMUMS AND (OBSTACLE) DEPARTURE PROCEDURES

AMDT 2A 21OCT10 (10294) (FAA)

TAKEOFF MINIMUMS:

Rwy 15, 500-2 or std. with a min. climb gradient of 270° per NM to 5700.

DEPARTURE PROCEDURE:

Rwy 15, turn right;

Rwy 33, turn left; climb direct BJC VOR/DME. Departures on BJC R-340 CW R-150 climb on course. All others climb in BJC holding pattern (NE, left turns 203° inbound) to cross BJC VOR/DME at or above 13300, or comply with RADAR vectors.

FARMINGTON, NM

FOUR CORNERS RGNL (FMN)

TAKEOFF MINIMUMS AND (OBSTACLE) DEPARTURE PROCEDURES

AMDT 1 29JUL10 (10210) (FAA)

DEPARTURE PROCEDURE:

Rwys 5, 23, 25, climbing right turn direct RSK VORTAC. Continue climb in RSK VORTAC holding pattern (hold East, left turn, 252° inbound) to cross RSK VORTAC at or above MEA for route of flight.

Rwy 7, climb direct RSK VORTAC. Continue climb in RSK VORTAC holding pattern (hold East, left turn, 252° inbound) to cross RSK VORTAC at or above MEA for route of flight.

TAKEOFF OBSTACLE NOTES:

Rwy 5, sign 27' from DER, 464' right of centerline, 13' AGL/5513' MSL.

Building 4005' from DER, 654' right of centerline, 96' AGL/5608' MSL.

Rwy 25, sign 37' from DER, 218' left of centerline, 10' AGL/5479' MSL.

Obstruction light on DME 200' from DER, 442' left of centerline, 24' AGL/5493' MSL.

Sign 37' from DER, 218' left of centerline, 10' AGL/5479' MSL.

FORT COLLINS, CO

NORTHERN COLORADO RGNL (FNL)

TAKEOFF MINIMUMS AND (OBSTACLE) DEPARTURE PROCEDURES

AMDT 5A 26APR18 (18116) (FAA)

TAKEOFF MINIMUMS:

Rwys 6, 24, NA-VFR runway.

DEPARTURE PROCEDURE:

Rwy 15, climb on a heading between 177° CCW to 329° from DER. All other courses: climbing left turn heading 017° to intercept GLL VOR/DME R-242 to GLL VOR/DME, thence...

Rwy 33, climb on a heading between 323° CW to 148° from DER. All other courses: climbing right turn heading 122° to intercept GLL VOR/DME R-257 to GLL VOR/DME, thence...

...climb in GLL VOR/DME holding pattern (hold NE, right turns, 205° inbound) to 16500 before proceeding on course.

TAKEOFF OBSTACLE NOTES:

Rwy 33, multiple trees beginning 833' from DER, 516' right of centerline, up to 66' AGL/5025' MSL.

Multiple poles beginning 567' from DER, 540' left of centerline, up to 26' AGL/4995' MSL.

DIVERSE VECTOR AREA (RADAR VECTORS)

AMDT 1 13SEP18 (18256) (FAA)

Rwys 15, 33 headings as assigned by ATC.

FORT MORGAN, CO

FORT MORGAN MUNI (FMM)

TAKEOFF MINIMUMS AND (OBSTACLE) DEPARTURE PROCEDURES

AMDT 1 04FEB16 (16035) (FAA)

TAKEOFF MINIMUMS:

Rwys 17, 35, 8, 26, NA-Environmental.

TAKEOFF OBSTACLE NOTES:

Rwy 14, ground and vehicle on road beginning 36' from DER, 157' left of centerline, up to 15' AGL/4528' MSL.

Buildings beginning 329' from DER, 577' right of centerline, up to 25' AGL/4527' MSL.

Rwy 32, ground beginning 13' from DER, 271' right of centerline, up to 4600' MSL.

GALLUP, NM

GALLUP MUNI (GUP)

TAKEOFF MINIMUMS AND (OBSTACLE) DEPARTURE PROCEDURES

AMDT 2 18AUG94 (94230) (FAA)

TAKEOFF MINIMUMS:

Rwy 6, CAT A,B 1300-2 or std. with a min. climb of 300' per NM until passing 8000. CAT C,D 1600-3 or std. with a min. climb of 320' per NM until passing 8500.

Rwy 24, 700-2 or std. with a min. climb of 370' per NM until passing 8000.

DEPARTURE PROCEDURE:

Rwy 6, turn left.

All aircraft climb direct GUP VORTAC. Departures via GUP R-190 CW R-242 climb on course. Departures via GUP R-243 CW R-189 climb in GUP holding pattern (SW, right turns, 047° inbound) to cross GUP at or above 9000.



TAKEOFF MINIMUMS, (OBSTACLE) DEPARTURE PROCEDURES, AND DIVERSE VECTOR AREA (RADAR VECTORS)



21224

SW-1



TAKEOFF MINIMUMS, (OBSTACLE) DEPARTURE PROCEDURES, AND DIVERSE VECTOR AREA (RADAR VECTORS)



21224

GRAND JUNCTION, CO

GRAND JUNCTION RGNL (GJT)

TAKEOFF MINIMUMS AND (OBSTACLE) DEPARTURE PROCEDURES

AMDT 11 25SEP08 (08269) (FAA)

TAKEOFF MINIMUMS:

Rwy 4, NA-obstacles.**Rwy 22**, NA-obstacles, facility reception (JNC VOR/DME).

DEPARTURE PROCEDURE:

Rwys 11, 29, use MONUMENT DEPARTURE.

GRANTS, NM

GRANTS-MILAN MUNI (GNT)

TAKEOFF MINIMUMS AND (OBSTACLE) DEPARTURE PROCEDURES

ORIG 11SEP97 (97254) (FAA)

TAKEOFF MINIMUMS:

Rwy 13, 2400-2 or std. with a min. climb of 420' per NM to 11000.**Rwy 31**, NA.

DEPARTURE PROCEDURE:

Rwy 13, climb runway heading to join V12 at or above 11000 before proceeding on course.

GREELEY, CO

GREELEY-WELD COUNTY (GXY)

TAKEOFF MINIMUMS AND (OBSTACLE) DEPARTURE PROCEDURES

AMDT 4 18SEP14 (14261) (FAA)

DEPARTURE PROCEDURE:

Rwy 10, climb on a heading between 292° CW to 214° from DER. All other headings: climbing left turn, thence...**Rwy 17**, climb on a heading between 212° CCW to 350° from DER. All other headings: climbing left turn, thence...**Rwy 28**, climb on a heading between 294° CW to 097° or 209° CCW to 097° from DER. All other headings: climbing right turn, thence...**Rwy 35**, climb on a heading between 293° CW to 169° from DER. All other headings: climbing right turn, thence...

...direct GLL VOR/DME, climb in GLL VOR/DME holding pattern (hold NE, right turns, 205° inbound) to 16500 before proceeding on course.

TAKEOFF OBSTACLE NOTES:

Rwy 28, tree 1634' from DER, 836' left of centerline, 56' AGL/4717' MSL.

Fence 237' from DER, 422' right of centerline, 11' AGL/4670' MSL.

Fence 99' from DER, 423' left of centerline, 10' AGL/4665' MSL.

Rwy 35, multiple trees beginning 1860' from DER, 595' right of centerline, up to 67' AGL/4785' MSL.

Tree 2854' from DER, 524' left of centerline, 73' AGL/4770' MSL.

DIVERSE VECTOR AREA (RADAR VECTORS)

ORIG 07DEC17 (17341) (FAA)

Rwys 10, 17, 28, 35, heading as assigned by ATC.

GUNNISON, CO

GUNNISON-CRESTED BUTTE RGNL (GUC)

TAKEOFF MINIMUMS AND (OBSTACLE) DEPARTURE PROCEDURES

AMDT 8 21JUL16 (16203) (FAA)

TAKEOFF MINIMUMS:

Rwy 6, std. w/ min. climb of 500' per NM to 9500, or 2500-3 for climb in VCOA.**Rwy 24**, std. w/ min. climb of 420' per NM to 9300, or 2500-3 for climb in VCOA.**Rwy 17, 35**, NA - Obstacles.

DEPARTURE PROCEDURE:

Rwy 6, climb heading 077° to 9500 then climbing right turn direct HBU VOR/DME, thence...**Rwy 24**, climb heading 242° to 9300 then climbing left turn direct HBU VOR/DME, thence...

...continue climb in HBU VOR/DME holding pattern (hold SW, LT, 031° inbound) to depart HBU VOR/DME at or above MEA/MCA for route of flight.

VCOA:

Rwy 6, 24, obtain ATC approval for climb in visual conditions when requesting IFR clearance. Climb in visual conditions to cross Gunnison-Crested Butte Rgnl airport at or above 10000, then on HBU R-31 to HBU VOR/DME, thence...

...continue climb in HBU VOR/DME holding pattern (hold SW, LT, 031° inbound) to depart HBU VOR/DME at or above MEA/MCA for route of flight.

TAKEOFF OBSTACLE NOTES:

Rwy 6, trees beginning 123' from DER, 478' right of centerline, up to 18' AGL/7697' MSL.

Vehicles on road 137' from DER, 529' left of centerline, 15' AGL/7693' MSL.

Trees beginning 1761' from DER, 109' left of centerline, up to 7745' MSL.

Trees beginning 4899' from DER, 792' left of centerline, up to 7821' MSL.

Poles beginning 1 NM from DER, 1906' left of centerline, up to 38' AGL/7850' MSL.

Grd and trees beginning 1.4 NM from DER, 1520' left of centerline, up to 8034' MSL.

Pole 1.5 NM from DER, 359' right of centerline, 26' AGL/7933' MSL.

Power transmission line, vehicles on road, grd, beginning 1.7 NM from DER, 1200' left of centerline, up to 8105' MSL.

Vehicles on road 1.9 NM from DER, 2288' left of centerline, 15' AGL/8070' MSL.

CON'T



TAKEOFF MINIMUMS, (OBSTACLE) DEPARTURE PROCEDURES, AND DIVERSE VECTOR AREA (RADAR VECTORS)



21224

SW-1



TAKEOFF MINIMUMS, (OBSTACLE) DEPARTURE PROCEDURES, AND DIVERSE VECTOR AREA (RADAR VECTORS)



21224

GUNNISON, CO (CON'T)

GUNNISON-CRESTED BUTTE RGNL (GUC) (CON'T)

Rwy 24, vehicles on road 570' from DER, 537' right of centerline, 15' AGL/7674' MSL.
Trees beginning 757' from DER, 603' left of centerline, up to 54' AGL/7704' MSL.
Pole 1126' from DER, 789' right of centerline, 7688' MSL.
Trees beginning 1155' from DER, crossing centerline, up to 52' AGL/7721' MSL.
Grd 1961' from DER, 1012' right of centerline, 7711' MSL.
Trees beginning 1991' from DER, crossing centerline, up to 68' AGL/7717' MSL.
Pole, grd, trees, beginning 2039' from DER, 191' right of centerline, up to 29' AGL/7726' MSL.
Poles and bldgs beginning 2471' from DER, 1072' right of centerline, up to 7732' MSL.
Tree 2614' from DER, 1033' right of centerline, 7734' MSL.
Bldgs beginning 2656' from DER, 731' right of centerline, up to 34' AGL/7737' MSL.
Pole, bldg, grd, beginning 2812' from DER, 902' right of centerline, up to 7754' MSL.
Grd beginning 3114' from DER, 1153' right of centerline, up to 7761' MSL.
Vehicles on road beginning 3439' from DER, 1229' right of centerline, 15' AGL/7771' MSL.
Poles beginning 4262' from DER, 1459' right of centerline, up to 7800' MSL.
Vehicles on road and poles beginning 4476' from DER, 1541' right of centerline, up to 7796' MSL.

HAYDEN, CO

YAMPA VALLEY (HDN)

TAKEOFF MINIMUMS AND (OBSTACLE) DEPARTURE PROCEDURES

AMDT 3 02JUL09 (09183) (FAA)

TAKEOFF MINIMUMS:

Rwy 10, std. w/ min. climb of 400' per NM to 12200, or 3200-3 for climb in visual conditions.

Rwy 28, std. w/ min. climb of 245' per NM to 9500, or 3200-3 for climb in visual conditions.

DEPARTURE PROCEDURE:

Rwy 10, climb on heading 147° to 12200 before proceeding on course.

Rwy 28, climb on heading 238° to 9500 before proceeding on course.

Rwys 10, 28, for climb in visual conditions: cross Yampa Valley airport at or above 9700 before proceeding on course.

TAKEOFF OBSTACLE NOTES:

Rwy 10, tree 241' from DER, 420' right of centerline, 100' AGL/6699' MSL.

Tree 644' from DER, 340' left of centerline, 100' AGL/6699' MSL.

Multiple transmission towers, beginning 3606' from DER, left to right of centerline, up to 145' AGL/6745' MSL.

Terrain beginning 1714' from DER, 707' right of centerline, up to 6676' MSL.

HOBBS, NM

LEA COUNTY RGNL (HOB)

TAKEOFF MINIMUMS AND (OBSTACLE) DEPARTURE PROCEDURES

ORIG-A 18OCT12 (12292) (FAA)

TAKEOFF OBSTACLE NOTES:

Rwy 3, multiple trees beginning 546' from DER, 811' right of centerline, up to 40' AGL/3700' MSL.

Sign 822' from DER, 694' left of centerline, 38' AGL/3676' MSL.

Rwy 12, road at DER, 112' right of centerline, 15' AGL/3654' MSL.

Rwy 17, obstruction light on glideslope, 1014' from DER, 486' right of centerline, 37' AGL/3687' MSL.

Rwy 21, tree 1304' from DER, 726' right of centerline, 46' AGL/3690' MSL.

Rwy 30, wind sock 103' from DER, 280' left of centerline, 16' AGL/3675' MSL.

Pole 1035' from DER, 540' right of centerline, 25' AGL/3689' MSL.

Rwy 35, multiple fences, roads and poles beginning 103' from DER, across centerline, up to 37' AGL/3696' MSL.

Pole 299' from DER, 495' left of centerline, 25' AGL/ 3689' MSL.

Pole 293' from DER, 94' right of centerline, 25' AGL/3682' MSL.

HOLLOMAN AFB (KHMN)

ALAMOGORDO, NM

TAKEOFF MINIMUMS AND (OBSTACLE) DEPARTURE PROCEDURES

AMDT 2 01FEB18 (18032) (USAF)

TAKEOFF MINIMUMS:

Rwy 4, 8000-3 or std. w/ min. climb of 473' per NM to 14,100.

Rwy 7, NA.

Rwy 16, 8000-3 or std. w/ min. climb of 496' per NM to 14,100.

Rwy 22, 8000-3 or std. w/ min. climb of 449' per NM to 14,100.

Rwy 25, 8000-3 or std. w/ min. climb of 488' per NM to 14,100.

Rwy 34, 8000-3 or std. w/ min. climb of 475' per NM to 14,100.

Rwys 4, 16, 22, 25, 34, RADAR REQUIRED (When R-5103C not under Holloman Approach or Cherokee control).

TAKEOFF OBSTACLE NOTES:

Rwy 4, terrain 4084' MSL, 16' from DER, 420' right of cntrln.

Aircraft tail 20' AGL/4101' MSL, 60' from DER, 546' right of cntrln.

Tree 180' AGL/4301' MSL, 1.2 NM from DER, 2504' right of cntrln.

Tree 180' AGL/4301' MSL, 1.3 NM from DER, 2488' right of cntrln.

Rwy 16, tree 60' AGL/4113' MSL, 3326' from DER, 925' left of cntrln.

Building 10' AGL/4059' MSL, 62' from DER, 270' right of cntrln.

CON'T



TAKEOFF MINIMUMS, (OBSTACLE) DEPARTURE PROCEDURES, AND DIVERSE VECTOR AREA (RADAR VECTORS)



21224

SW-1



TAKEOFF MINIMUMS, (OBSTACLE) DEPARTURE PROCEDURES, AND DIVERSE VECTOR AREA (RADAR VECTORS)



21224

HOLLOMAN AFB (KHMM) (CON'T)

ALAMOGORDO, NM (CON'T)

Rwy 16 (CON'T), building 10' AGL/4060' MSL, 57' from DER, 270' left of cntrln.

Tree 60' AGL/4110' MSL, 3084' from DER, 1216' left of cntrln.

Terrain 4052' MSL, 8' from DER, 320' left of cntrln.

Terrain 4052' MSL, 0' from DER, 500' left of cntrln.

Building 9' AGL/4059' MSL, 124' from DER, 90' left of cntrln.

Tree 180' AGL/4219' MSL, 1.1 NM from DER, 980' left of cntrln.

Tree 180' AGL/4223' MSL, 5877' from DER, 2075' left of cntrln.

Rwy 22, terrain 4058' MSL, 0' from DER, 500' left of cntrln.

Terrain 4058' MSL, 14' from DER, 327' left of cntrln.

Terrain 4058' MSL, 0' from DER, 28' right of cntrln.

Terrain 4058' MSL, 53' from DER, 391' right of cntrln.

Terrain 4058' MSL, 0' from DER, 353' right of cntrln.

Terrain 4059' MSL, 0' from DER, 500' right of cntrln.

Aircraft tail 20' AGL/4069' MSL, 26' inward of DER, 414' left of cntrln.

Tree 180' AGL/4252' MSL, 1.2 NM from DER, 13' right of cntrln.

Tree 180' AGL/4258' MSL, 5894' from DER, 2081' right of cntrln.

Rwy 25, vehicle 12' AGL/4064' MSL, 1090' from DER, 591' left of cntrln.

Aircraft tail 20' AGL/4069' MSL, 121' from DER, 232' left of cntrln.

Terrain 4054' MSL, 0' from DER, 500' left of cntrln.

Terrain 4055' MSL, 17' from DER, 450' left of cntrln.

Terrain 4055' MSL, 18' from DER, 475' right of cntrln.

Terrain 4055' MSL, 0' from DER, 500' right of cntrln.

Terrain 4055' MSL, 63' from DER, 517' right of cntrln.

Tree 180' AGL/4258' MSL, 1.3 NM from DER, 205' left of cntrln.

Tree 180' AGL/4252' MSL, 6029' from DER, 1287' right of cntrln.

Rwy 34, tree 180' AGL/4268' MSL, 1.1 NM from DER, 1408' left of cntrln.

Tree 180' AGL/4278' MSL, 5950' from DER, 1781' right of cntrln.

Terrain 4083' MSL, 28' from DER, 290' right of cntrln.

DIVERSE VECTOR AREA (RADAR VECTORS)

ORIG 25FEB21 (21056) (USAF)

Rwy 4, heading as assigned by ATC; required min. climb of 273' per NM to 12,000.

Rwy 16, heading as assigned by ATC; required min. climb of 229' per NM to 12,000.

Rwy 22, heading as assigned by ATC; required min. climb of 266' per NM to 12,000.

Rwy 25, heading as assigned by ATC; required min. climb of 264' per NM to 12,000.

Rwy 34, heading as assigned by ATC; required min. climb of 257' per NM to 12,000.

HOLYOKE, CO

HOLYOKE (HEQ)

TAKEOFF MINIMUMS AND (OBSTACLE) DEPARTURE PROCEDURES

AMDT 1 15DEC11 (11349) (FAA)

TAKEOFF MINIMUMS:

Rwy 32, 300-1 or std. w/min. climb of 280' per NM to 4000.

TAKEOFF OBSTACLE NOTES:

Rwy 14, trees 2011' from DER, 29' left of centerline, 100' AGL/3829' MSL.

Rwy 32, trees 1009' from DER, 697' left of centerline, 100' AGL/3839' MSL.

Tower 4448' from DER, 1036' left of centerline, 165' AGL/3886' MSL.

KREMMLING, CO

MC ELROY AIRFIELD (20V)

TAKEOFF MINIMUMS AND (OBSTACLE) DEPARTURE PROCEDURES

TAKEOFF MINIMUMS:

Rwy 9, 2600-2 or std. with a min. climb of 370' per NM to 12700.

Rwy 27, 3200-2 or std. with a min. climb of 500' per NM to 12700.

DEPARTURE PROCEDURE:

Rwy 9, climb runway heading to 10000, then climbing right turn.

Rwy 27, climb runway heading to 10900, then climbing left turn.

All aircraft proceed direct RLG VOR/DME. Continue climb to 13,000 in RLG holding pattern (hold SW, left turns, 051° inbound).

09 SEP 2021 to 07 OCT 2021

09 SEP 2021 to 07 OCT 2021



21224

SW-1



TAKEOFF MINIMUMS, (OBSTACLE) DEPARTURE PROCEDURES, AND DIVERSE VECTOR AREA (RADAR VECTORS)



21224

LA JUNTA, CO

LA JUNTA MUNI (LHX)

TAKEOFF MINIMUMS AND (OBSTACLE) DEPARTURE PROCEDURES

AMDT 3A 31MAR16 (16091) (FAA)

DEPARTURE PROCEDURE:

Rwy 8, climb via heading 080°.**Rwy 12**, climb via heading 120°.**Rwy 26**, turn left heading 160°.**Rwy 30**, turn left heading 140°.**All aircraft**, intercept LAA R-238 (V210) to LAA VOR/DME. When at or above 8000 proceed on course.

TAKEOFF OBSTACLE NOTES:

Rwy 26, rod 196' from DER, 445' left of centerline, 10' AGL/4241' MSL.

Fence 224' from DER, 198' right of centerline, 7' AGL/4235' MSL.

LAMAR, CO

SOUTHEAST COLORADO RGNL (LAA)

TAKEOFF MINIMUMS AND (OBSTACLE) DEPARTURE PROCEDURES

ORIG-B 21MAY20 (20142) (FAA)

DEPARTURE PROCEDURE:

Rwys 8, 36, climbing left turn direct LAA VOR/DME, thence...**Rwy 18**, climbing left/right turn direct LAA VOR/DME, thence...**Rwy 26**, climbing right turn direct LAA VOR/DME, thence...

Aircraft departing LAA R-048 CW R-118 climb on course. All others continue climb in LAA holding pattern (north, right turns, 169° inbound) to 6000 before proceeding on course.

TAKEOFF OBSTACLE NOTES:

Rwy 8, tree 977' from DER, 415' left of centerline, 3725' MSL.**Rwy 18**, fence, terrain beginning 130' from DER, 341' left of centerline, up to 3724' MSL.

Terrain beginning 433' from DER, 498' left of centerline, up to 3729' MSL.

Fence 552' from DER, 398' left of centerline, 9' AGL/3733' MSL.

Terrain 1309' from DER, 247' left of centerline, 3739' MSL.

LAS CRUCES, NM

LAS CRUCES INTL (LRU)

TAKEOFF MINIMUMS AND (OBSTACLE) DEPARTURE PROCEDURES

AMDT 2 18AUG16 (16231) (FAA)

TAKEOFF MINIMUMS:

Rwys 4, 8, 12, 22, 26, 30, 2500-3 for climb in visual conditions.

VCOA:

All runways, obtain ATC approval for climb in visual conditions when requesting IFR clearance. Climb in visual conditions to cross Las Cruces Intl southwest bound at or above 6500 on CUS VOR/DME R-038 to ZAXOX INT/DMN 27 DME. Continue climb in ZAXOX holding pattern (hold W, right turns, 094° inbound) to cross ZAXOX at or above MEA or assigned altitude for route of flight.

TAKEOFF OBSTACLE NOTES:

Rwy 4, bush beginning 67' from DER, 169' right of centerline, up to 8' AGL/4458' MSL.

Tree, bush, vegetation beginning 122' from DER, 180' right of centerline, up to 10' AGL/4460' MSL.

Tree, bush, pole, It support structure beginning 8' from DER, 29' left of centerline, up to 4459' MSL.

Bush beginning 187' from DER, 372' left of centerline, up to 4462' MSL.

Tree, bush, vegetation beginning 192' from DER, 331' left of centerline, up to 4462' MSL.

Bush, tree beginning 347' from DER, 219' left of centerline, up to 4463' MSL.

Tree 463' from DER, 427' left of centerline, 4464' MSL.

Tree 480' from DER, 254' left of centerline, 4465' MSL.

Tree 520' from DER, 251' left of centerline, 4467' MSL.

Rwy 8, pole, It support structure, bush beginning 12' from DER, 29' left of centerline, up to 9' AGL/4437' MSL.

Bush beginning 46' from DER, 428' left of centerline, up to 4439' MSL.

Bush 87' from DER, 487' left of centerline, 4440' MSL.

Bush beginning 188' from DER, 371' left of centerline, up to 5' AGL/4443' MSL.

Bush 240' from DER, 359' left of centerline, 4444' MSL.

Trees beginning 360' from DER, 504' left of centerline, up to 4448' MSL.

Tree 542' from DER, 643' left of centerline, 4451' MSL.

Rwy 12, bush beginning 106' from DER, 351' right of centerline, up to 4443' MSL.**Rwy 22**, bush 30' from DER, 489' right of centerline, 4440' MSL.

Bush 5' from DER, 365' left of centerline, 4439' MSL.

Pole, It support structure beginning 11' from DER, 30' right of centerline, up to 3' AGL/4437' MSL.

Tree, bush beginning 31' from DER, 352' left of centerline, up to 4441' MSL.

Tree, bush beginning 126' from DER, 221' left of centerline, up to 9' AGL/4444' MSL.

Rwy 26, vegetation, It support structure, pole beginning 4' from DER, 30' right of centerline, up to 5' AGL/4440' MSL.

Bush beginning 24' from DER, 358' right of centerline, up to 4444' MSL.

Tree, bush beginning 38' from DER, 245' right of centerline, up to 4445' MSL.

Tree, bush beginning 43' from DER, 173' right of centerline, up to 8' AGL/4446' MSL.

Tree, bush, vegetation beginning 147' from DER, 260' left of centerline, up to 11' AGL/4449' MSL.

Bush 27' from DER, 451' left of centerline, 4439' MSL.

CON'T

09 SEP 2021 to 07 OCT 2021

09 SEP 2021 to 07 OCT 2021



TAKEOFF MINIMUMS, (OBSTACLE) DEPARTURE PROCEDURES, AND DIVERSE VECTOR AREA (RADAR VECTORS)



21224

SW-1



TAKEOFF MINIMUMS, (OBSTACLE) DEPARTURE PROCEDURES, AND DIVERSE VECTOR AREA (RADAR VECTORS)



21224

LAS CRUCES, NM (CON'T)

LAS CRUCES INTL (LRU) (CON'T)

- Rwy 30**, tree 12' from DER, 276' right of centerline, 4463' MSL.
Tree, bush beginning 15' from DER, 290' right of centerline, up to 10' AGL/4465' MSL.
Tree 52' from DER, 429' right of centerline, 11' AGL/4466' MSL.
Trees beginning 135' from DER, 279' right of centerline, up to 13' AGL/4468' MSL.
Trees beginning 97' from DER, 318' left of centerline, up to 4466' MSL.
Trees beginning 230' from DER, 316' left of centerline, up to 4467' MSL.
Tree 420' from DER, 544' left of centerline, 4468' MSL.

LAS VEGAS, NM

LAS VEGAS MUNI (LVS)

TAKEOFF MINIMUMS AND (OBSTACLE) DEPARTURE PROCEDURES

AMDT 1 13APR06 (06103) (FAA)

DEPARTURE PROCEDURE:

Rwys 2, 14 turn left/right.

Rwy 20, turn left (except via FTI R-215).

Rwy 32, turn right.

Departures via FTI VORTAC R-001 CW R-215 climb on course. Departures via FTI VORTAC R-216 CW R-360 proceed direct FTI VORTAC. Climb in FTI VORTAC holding pattern (hold north, left turn, 192° inbound) to cross FTI at airway MEA/MCA. (NOTE: climb in hold not authorized for turbojet aircraft).

LEADVILLE, CO

LAKE COUNTY (LXV)

TAKEOFF MINIMUMS AND (OBSTACLE) DEPARTURE PROCEDURES

AMDT 2A 28FEB19 (19059) (FAA)

DEPARTURE PROCEDURE:

Rwy 16, use LOZUL (RNAV) DEPARTURE.

Rwy 34, use DAVVY (RNAV) DEPARTURE.

TAKEOFF OBSTACLE NOTES:

- Rwy 16**, poles, signs beginning 9' from DER, 17' left of centerline, up to 2' AGL/9926' MSL.
Pole 10' from DER, 17' right of centerline, 2' AGL/9926' MSL.
Trees beginning 180' from DER, 516' left of centerline, up to 9948' MSL.
Transmission line, poles beginning 499' from DER, 632' left of centerline, up to 101' AGL/9989' MSL.
Rwy 34, pole 10' from DER, 26' left of centerline, 2' AGL/9932' MSL.
Trees beginning 18' from DER, 462' right of centerline, up to 9949' MSL.

LONGMONT, CO

VANCE BRAND (LMO)

TAKEOFF MINIMUMS AND (OBSTACLE) DEPARTURE PROCEDURES

AMDT 2 03DEC20 (20338) (FAA)

TAKEOFF MINIMUMS:

Rwy 29, std. w/ min. climb of 370' per NM to 7000 or 7300 and 3 for VCOA.

DEPARTURE PROCEDURE:

Rwy 11, climbing left turn heading 022° to intercept GLL VOR/DME R-221 to 7000...

Rwy 29, climbing right turn heading 063° to intercept GLL VOR/DME R-221 to 7000...

...All aircraft proceed on GLL VOR/DME R-221 to GLL VOR/DME. Cross GLL VOR/DME at or above the MEA/MCA for the route of flight.

TAKEOFF OBSTACLE NOTES:

- Rwy 11**, sign 21' from DER, 204' left of centerline, 2' AGL/5032' MSL.
Traverse way 203' from DER, 470' left of centerline, 5041' MSL.
Tree 311' from DER, 518' left of centerline, 5042' MSL.
Tree, building beginning 674' from DER, 528' right of centerline, up to 5059' MSL.
Tree, pole beginning 842' from DER, 577' right of centerline, up to 5062' MSL.
Tree 1812' from DER, 683' left of centerline, 5077' MSL.
Rwy 29, terrain 12' from DER, 227' left of centerline, 5056' MSL.
Tree 54' from DER, 320' right of centerline, 5058' MSL.
Tree 82' from DER, 154' left of centerline, 5071' MSL.
Trees beginning 92' from DER, 112' left of centerline, up to 23' AGL/5082' MSL.
Tree 1056' from DER, 248' right of centerline, 5093' MSL.
Trees beginning 1088' from DER, 371' right of centerline, up to 77' AGL/5139' MSL.
Trees beginning 1203' from DER, 20' right of centerline, up to 80' AGL/5144' MSL.
Tree 1633' from DER, 612' left of centerline, 5102' MSL.
Trees beginning 1757' from DER, 554' left of centerline, up to 5126' MSL.
Tree 2095' from DER, 176' left of centerline, 5127' MSL.
Tree 2518' from DER, 773' right of centerline, 5149' MSL.
Trees beginning 2571' from DER, 931' right of centerline, up to 5152' MSL.
Tree 3783' from DER, 1316' right of centerline, 5168' MSL.
Tree 3823' from DER, 1519' right of centerline, 5176' MSL.
Trees beginning 4106' from DER, 979' right of centerline, up to 5177' MSL.
Trees beginning 4465' from DER, 1120' right of centerline, up to 5196' MSL.
Trees beginning 4519' from DER, 714' right of centerline, up to 93' AGL/5198' MSL.
Tree 5482' from DER, 276' left of centerline, 5198' MSL.

09 SEP 2021 to 07 OCT 2021

09 SEP 2021 to 07 OCT 2021



TAKEOFF MINIMUMS, (OBSTACLE) DEPARTURE PROCEDURES, AND DIVERSE VECTOR AREA (RADAR VECTORS)



21224

SW-1



TAKEOFF MINIMUMS, (OBSTACLE) DEPARTURE PROCEDURES, AND DIVERSE VECTOR AREA (RADAR VECTORS)



21224

LONGMONT, CO (CON'T)

VANCE BRAND (LMO) (CON'T)

DIVERSE VECTOR AREA (RADAR VECTORS)

ORIG 16JUL20 (20198) (FAA)

Rwy 11, headings as assigned by ATC.

Rwy 29, headings as assigned by ATC; requires min. climb of 370' per NM to 6500.

LOS ALAMOS, NM

LOS ALAMOS (LAM)

TAKEOFF MINIMUMS AND (OBSTACLE) DEPARTURE PROCEDURES

AMDT 1 31MAY12 (12152) (FAA)

TAKEOFF MINIMUMS:

Rwy 27, NA-obstacles and airport restriction.

DEPARTURE PROCEDURE:

Rwy 9, climb heading 092° to intercept SAF R-354. Northbound climbing to 11000 on V83. Southbound climbing to 9000 on V83.

TAKEOFF OBSTACLE NOTES:

Rwy 9, terrain and trees beginning 101' from DER, 178' left and right of centerline, up to 60' AGL/7139' MSL.

LOVINGTON, NM

LEA COUNTY-ZIP FRANKLIN MEML (E06)

TAKEOFF MINIMUMS AND (OBSTACLE) DEPARTURE PROCEDURES

AMDT 1 30DEC99 (21112) (FAA)

DEPARTURE PROCEDURE:

Rwy 3, climb runway heading to 4700 before turning on course.

TAKEOFF OBSTACLE NOTES:

Rwy 12, 35' AGL power line 1250' from DER 150' right of centerline.

Rwy 21, 40' AGL tower 936' from DER 273' right of centerline.

Rwy 30, 50' AGL windmill 1800' from DER 50' right of centerline.

MEEKER, CO

MEEKER COULTER FLD (EEO)

TAKEOFF MINIMUMS AND (OBSTACLE) DEPARTURE PROCEDURES

AMDT 1 05JUN08 (21196) (FAA)

TAKEOFF MINIMUMS:

Rwys 3, 21, 4100-3 for climb in visual conditions.

DEPARTURE PROCEDURE:

Rwys 3, 21, for climb in visual conditions: cross Meeker Coulter Fld airport at or above 10500 before proceeding on course.

TAKEOFF OBSTACLE NOTES:

Rwy 21, multiple trees beginning 843' from DER, 20' left of centerline, up to 100' AGL/7190' MSL.

Multiple trees beginning 227' from DER, 187' right of centerline, up to 100' AGL/6862' MSL.

MONTE VISTA, CO

MONTE VISTA MUNI (MVI)

TAKEOFF MINIMUMS AND (OBSTACLE) DEPARTURE PROCEDURES

AMDT 4 07DEC17 (17341) (FAA)

TAKEOFF MINIMUMS:

Rwys 10, 16, 28, 34, NA - Rwy surfaces.

DEPARTURE PROCEDURE:

Rwy 2, climbing right turn direct ALS VORTAC, thence . . .

Rwy 20, climbing left turn direct ALS VORTAC, thence . . .

. . . climb-in-holding pattern (SE, right turn, 301° inbound) to cross ALS VORTAC at or above MEA for route of flight.

TAKEOFF OBSTACLE NOTES:

Rwy 2, NAVAID 10' from DER, 9' left of centerline, 2' AGL/7611' MSL.

Tree 14' from DER, 203' right of centerline, 7612' MSL.

Tree 111' from DER, 464' right of centerline, 8' AGL/7614' MSL.

Tank 313' from DER, 444' left of centerline, 18' AGL/7626' MSL.

Traverse way beginning 317' from DER, 383' right of centerline, up to 7621' MSL.

Tower, poles beginning 401' from DER, 396' left of centerline, up to 48' AGL/7658' MSL.

Rwy 2, trees, poles beginning 910' from DER, 411' right of centerline, up to 57' AGL/7665' MSL.

Tree 2558' from DER, 126' left of centerline, 7674' MSL.

Rwy 20, NAVAID 11' from DER, 9' left of centerline, 7613' MSL.

Fence 67' from DER, 283' left of centerline, 9' AGL/7615' MSL.

MONTROSE, CO

MONTROSE RGNL (MTJ)

TAKEOFF MINIMUMS AND (OBSTACLE) DEPARTURE PROCEDURES

AMDT 4 07MAY09 (09127) (FAA)

DEPARTURE PROCEDURE:

Use MONTROSE DEPARTURE.



TAKEOFF MINIMUMS, (OBSTACLE) DEPARTURE PROCEDURES, AND DIVERSE VECTOR AREA (RADAR VECTORS)



21224

SW-1



TAKEOFF MINIMUMS, (OBSTACLE) DEPARTURE PROCEDURES, AND DIVERSE VECTOR AREA (RADAR VECTORS)



21224

MORIARTY, NM

MORIARTY MUNI (0E0)

TAKEOFF MINIMUMS AND (OBSTACLE) DEPARTURE PROCEDURES

ORIG-A 19JUL18 (18200) (FAA)

DEPARTURE PROCEDURE:

Rwy 8, climb heading 079° to 7100 before proceeding on course.

Rwy 18, climb heading 169° to 6900 before proceeding on course.

Rwys 26, 36, climbing right turn direct OTO VOR, continue climb in OTO VOR holding pattern (hold east, RT, 254° inbound) to cross OTO VOR at or above MEA for route of flight.

TAKEOFF OBSTACLE NOTES:

Rwy 8, fence 86' from DER, 393' right of centerline, 4' AGL/6189' MSL.

Rwy 26, bush 4' from DER, 462' right of centerline, 6207' MSL.

Bush 67' from DER, 9' left of centerline, 6206' MSL.

Tree 1689' from DER, 395' right of centerline, 6248' MSL.

Tree 1851' from DER, 248' right of centerline, 49' AGL/6256' MSL.

Rwy 36, windsock 63' from DER, 323' right of centerline, 11' AGL/6193' MSL.

AWOS antenna 778' from DER, 605' left of centerline, 31' AGL/6218' MSL.

Power transmission line 1323' from DER, 389' left of centerline, 6222' MSL.

NUCLA, CO

HOPKINS FIELD (AIB)

TAKEOFF MINIMUMS AND (OBSTACLE) DEPARTURE PROCEDURES

ORIG 10MAY07 (07130) (FAA)

TAKEOFF MINIMUMS:

Rwys 11, 29, NA-environmental

DEPARTURE PROCEDURE:

Rwys 5, 23, use NUCLA (RNAV) DEPARTURE.

PAGOSA SPRINGS, CO

STEVENS FIELD (PSO)

TAKEOFF MINIMUMS AND (OBSTACLE) DEPARTURE PROCEDURES

ORIG 14FEB08 (08045) (FAA)

TAKEOFF MINIMUMS:

Rwy 1, std. w/ min. climb of 437' per NM to 9600, or 1900-3 for climb in visual conditions.

Rwy 19, std. w/ min. climb of 296' per NM to 9300, or 1900-3 for climb in visual conditions.

DEPARTURE PROCEDURE:

Rwy 1, climbing right turn via heading 216° to intercept DRO VOR/DME R-066 to DRO VOR/DME for climb in visual conditions cross Stevens Field airport south bound at or above 9400 MSL, then via DRO VOR/DME R-066 to DRO VOR/DME

Rwy 19, climb via heading 194° to intercept DRO VOR/DME R-075 to DRO VOR/DME for climb in visual conditions cross Stevens Field airport south bound at or above 9400 MSL, then via DRO VOR/DME R-066 to DRO VOR/DME

... thence cross DRO VOR/DME at MEA/MCA for direction of flight before proceeding on course.

TAKEOFF OBSTACLE NOTES:

Rwy 1, terrain beginning 30' from DER, 53' left of centerline, up to 7697' MSL.

Terrain beginning 127' from DER, 69' right of centerline, up to 7681' MSL.

Multiple trees beginning 940' from DER, left and right of centerline, up to 100' AGL/7739' MSL.

Rwy 19, multiple trees beginning 664' from DER, 156' left of centerline, up to 100' AGL/7693' MSL.

Multiple trees beginning 1625' from DER, 5' right of centerline, up to 100' AGL/7698' MSL.

PORTALES, NM

PORTALES MUNI (PRZ)

TAKEOFF MINIMUMS AND (OBSTACLE) DEPARTURE PROCEDURES

ORIG 31MAY12 (12152) (FAA)

TAKEOFF OBSTACLE NOTES:

Rwy 8, train on tracks, 624' from DER, left and right of centerline, up to 23' AGL/4087' MSL.

Terrain beginning 35' from DER, left and right of centerline, 4064' MSL.

Vehicles on road, 794' from DER, left and right of centerline, up to 17' AGL/4081' MSL.

Rwy 19, terrain beginning 13' from DER, left and right of centerline, 4080' MSL.

Rwy 26, terrain beginning 15' from DER, left and right of centerline, 4074' MSL.

09 SEP 2021 to 07 OCT 2021

09 SEP 2021 to 07 OCT 2021



TAKEOFF MINIMUMS, (OBSTACLE) DEPARTURE PROCEDURES, AND DIVERSE VECTOR AREA (RADAR VECTORS)



21224

SW-1



TAKEOFF MINIMUMS, (OBSTACLE) DEPARTURE PROCEDURES, AND DIVERSE VECTOR AREA (RADAR VECTORS)



21224

PUEBLO, CO

PUEBLO MEML (PUB)

TAKEOFF MINIMUMS AND (OBSTACLE) DEPARTURE PROCEDURES

AMDT 7 26MAY16 (21056) (FAA)

TAKEOFF MINIMUMS:

Rwys 8L, 26R, NA, Environmental.

Rwy 35, 400-2¼ or std. w/min. climb of 343' per NM to 5200.

DEPARTURE PROCEDURE:

Rwy 8R, climb heading 080° to 5500, then climbing left turn to intercept PUB R-045 to PUB VORTAC, thence ...

Rwy 17, climb heading 170° to 5800, then climbing left turn on heading 050° and PUB R-185 to PUB VORTAC, thence ...

Rwy 26L, climb heading 260° to 5700, then climbing left turn on heading 070° and PUB R-225 to PUB VORTAC, thence ...

Rwy 35, climb heading 350° to 5200, then climbing right turn on heading 150° and PUB R-005 to PUB VORTAC, thence ...

... Continue climb in PUB VORTAC holding pattern (hold E, right turns, 249° inbound) to cross PUB VORTAC at or above MEA for route of flight.

TAKEOFF OBSTACLE NOTES:

Rwy 8R, rising terrain 378' from DER, 594' left of centerline, up to 4859' MSL.

Rwy 17, pole 666' from DER, 661' right of centerline, 46' AGL/4876' MSL.

Rwy 26L, rising terrain 26' from DER, 497' right of centerline, up to 4679' MSL.

Rwy 35, rising terrain 178' from DER, left and right of centerline, up to 4769' MSL.

Bushes beginning 23' from DER, left and right of centerline, up to 13' AGL/4750' MSL.

Transmission line towers beginning 1.1 NM from DER, left and right of centerline, up to 57' AGL/4950' MSL.

Radar reflector 995' from DER, on centerline, 4' AGL/4757' MSL.

Tree 3604' from DER, 1452' right of centerline, 4889' MSL.

Tree 1.5 NM from DER, 1854' right of centerline, 5069' MSL.

Terrain 1.8 NM from DER, 3169' right of centerline, 5020' MSL.

RANGELY, CO

RANGELY (4V0)

TAKEOFF MINIMUMS AND (OBSTACLE) DEPARTURE PROCEDURES

ORIG 19JUL18 (18200) (FAA)

DEPARTURE PROCEDURE:

Rwys 7, 25, use ELIZZ (RNAV) DEPARTURE.

RATON, NM

RATON MUNI/CREWS FLD (RTN)

TAKEOFF MINIMUMS AND (OBSTACLE) DEPARTURE PROCEDURES

AMDT 1 07APR11 (21224) (FAA)

TAKEOFF MINIMUMS:

Rwy 2, std. w/min. climb of 251' per NM to 9600 or 2100-3 for climb in visual conditions.

Rwy 7, std. w/min. climb of 367' per NM to 9300 or 2100-3 for climb in visual conditions.

DEPARTURE PROCEDURE:

Rwy 2, climbing right turn heading 090° and CIM VORTAC R-040 northeast bound to airway MEA, then on course to assigned altitude, or for climb in visual conditions, cross Raton Muni/Crews Fld at or above 8400 before proceeding on course.

Rwy 7, for climb in visual conditions, cross Raton Muni/Crews Fld at or above 8400 before proceeding on course.

Rwy 20, climb on CIM VORTAC R-040 southwest bound to airway MEA, if not at MEA by CIM VORTAC, turn south on V263-611 until reaching MEA, then on course to assigned altitude.

Rwy 25, climbing left turn heading 227° and CIM VORTAC R-040 southwest bound to airway MEA, if not at MEA by CIM VORTAC, turn south on V263-611 until reaching MEA, then on course to assigned altitude.

RIFLE, CO

RIFLE GARFIELD COUNTY (RIL)

TAKEOFF MINIMUMS AND (OBSTACLE) DEPARTURE PROCEDURES

AMDT 11 01FEB18 (18032) (FAA)

TAKEOFF MINIMUMS:

Rwy 8, std. w/ min. climb of 400' per NM to 11900 or 5400 - 5 for VCOA.

DEPARTURE PROCEDURE:

Rwy 8, DME required. Climb on RIL VOR/DME R-083 to ZOBAK/7.41 DME, then climbing left turn direct RIL VOR/DME. Climb in RIL VOR/DME holding pattern (hold E, right turn, 263° inbound) to cross RIL VOR/DME at or above MEA/MCA before proceeding enroute.

Rwy 26, use SQUAT DEPARTURE.

VCOA:

Rwy 8, obtain ATC approval for VCOA when requesting IFR clearance. Climb in visual conditions to cross Rifle Garfield County Airport at or above 10800 before proceeding on course.

TAKEOFF OBSTACLE NOTES:

Rwy 8, terrain beginning 155' from DER, 380' right of centerline, up to 5551' MSL.

Pole 4049' from DER, 1379' right of centerline, 42' AGL/5642' MSL.

Obstruction light on NDB tower, 41' from DER, 300' left of centerline, 46' AGL/5586' MSL.



TAKEOFF MINIMUMS, (OBSTACLE) DEPARTURE PROCEDURES, AND DIVERSE VECTOR AREA (RADAR VECTORS)



21224

SW-1



TAKEOFF MINIMUMS, (OBSTACLE) DEPARTURE PROCEDURES, AND DIVERSE VECTOR AREA (RADAR VECTORS)



21224

ROSWELL, NM

ROSWELL AIR CENTER (ROW)

TAKEOFF MINIMUMS AND (OBSTACLE) DEPARTURE PROCEDURES

ORIG-B 26MAR20 (20086) (FAA)

DEPARTURE PROCEDURE:

Rwy 35, climbing left turn to 6000 on heading 277° to intercept CME R-323, upon reaching 6000 proceed on course.

TAKEOFF OBSTACLE NOTES:

Rwy 35, tower 1970' from DER 926' left of centerline, 93' AGL/3755' MSL

RUIDOSO, NM

SIERRA BLANCA RGNL (SRR)

TAKEOFF MINIMUMS AND (OBSTACLE) DEPARTURE PROCEDURES

ORIG-A 25FEB21 (21056) (FAA)

DEPARTURE PROCEDURE:

Use CAPITAN DEPARTURE.

TAKEOFF OBSTACLE NOTES:

Rwy 12, terrain, 9' from DER, 5' right of centerline, 6722' MSL.

Trees, beginning 61' from DER, 146' left of centerline, up to 6727' MSL.

Tree, 99' from DER, 125' right of centerline, 6725' MSL.

Rwy 24, tree, 648' from DER, 264' right of centerline, 11' AGL/6832' MSL.

Trees, beginning 747' from DER, 300' left of centerline, up to 15' AGL/6835' MSL.

Vehicle on road, 940' from DER, 39' left of centerline, up to 15' AGL/6854' MSL.

Pole, 4427' from DER, 942' left of centerline, 45' AGL/6925' MSL.

Rwy 30, sign, 47' from DER, 60' right of centerline, 6774' MSL.

Sign, 72' from DER, 197' left of centerline, up to 2' AGL/6779' MSL.

Vehicle on road, 436' from DER, 253' right of centerline, 15' AGL/6787' MSL.

Tree, 692' from DER, 179' left of centerline, 6796' MSL.

Building, tree, beginning 753' from DER, 308' left of centerline, up to 30' AGL/6808' MSL.

Pole, 1092' from DER, 433' left of centerline, 76' AGL/6845' MSL.

Pole, 1201' from DER, 633' left of centerline, 67' AGL/6847' MSL.

Pole, 1693' from DER, 908' left of centerline, 69' AGL/6853' MSL.

SALIDA, CO

SALIDA AIRPORT HARRIET ALEXANDER FIELD (ANK)

TAKEOFF MINIMUMS AND (OBSTACLE) DEPARTURE PROCEDURES

AMDT 1A 15AUG19 (19227) (FAA)

TAKEOFF MINIMUMS:

Rwys 6, 24, 6800-5 for VCOA. VCOA NA at night.

VCOA:

Obtain ATC approval for VCOA when requesting IFR clearance. Climb in visual conditions to cross Salida Airport Harriet Alexander Field at or above 14200. For westbound V-95, climb on heading 263° to 17000 and proceed on course. For eastbound V-95, climb on heading 062° to 17000 and proceed on course.

TAKEOFF OBSTACLE NOTES:

Rwy 6, NAVAID, lighting beginning 5' from DER, 27' right of centerline, up to 3' AGL/7387' MSL.

Fence, NAVAID, lighting beginning 6' from DER, 27' left of centerline, up to 8' AGL/7391' MSL.

Trees beginning 22' from DER, 410' right of centerline, up to 7396' MSL.

Tree 61' from DER, 287' left of centerline, 7392' MSL.

Vehicle on road 2.4 NM from DER, 2608' right of centerline, 7778' MSL.

Trees beginning 2.5 NM from DER, 1053' right of centerline, up to 7939' MSL.

Trees beginning 2.5 NM from DER, 1345' right of centerline, up to 7961' MSL.

Rwy 24, lighting 9' from DER, 28' right of centerline, 3' AGL/7525' MSL.

Pole, lighting, NAVAID beginning 9' from DER, 27' left of centerline, up to 2' AGL/7525' MSL.

Tree, NAVAID beginning 21' from DER, 77' right of centerline, up to 7539' MSL.

Trees beginning 52' from DER, 299' right of centerline, up to 7547' MSL.

Vehicle on road 196' from DER, 402' left of centerline, 7541' MSL.

Tree, fence beginning 340' from DER, 2' right of centerline, up to 7548' MSL.

Pole, tree, fence beginning 373' from DER, 71' left of centerline, up to 16' AGL/7545' MSL.

Tree, vehicle on road beginning 637' from DER, 66' left of centerline, up to 7565' MSL.

Transmission line, pole, vehicle on road, tree beginning 666' from DER, 97' right of centerline, up to 65' AGL/7595' MSL.

Tree 1031' from DER, 294' left of centerline, 7571' MSL.

Tree, fence beginning 1045' from DER, 53' left of centerline, up to 7573' MSL.

Trees beginning 1264' from DER, 228' left of centerline, up to 7596' MSL.

Catenary 1295' from DER, 352' right of centerline, 57' AGL/7605' MSL.

Rwy 24, pole, tree, vehicle on road beginning 1364' from DER, 343' right of centerline, up to 57' AGL/7606' MSL.

Trees beginning 1414' from DER, 211' left of centerline, up to 7603' MSL.

Tree, vehicle on road beginning 1557' from DER, 67' left of centerline, up to 7604' MSL.

Trees beginning 1729' from DER, 50' left of centerline, up to 7619' MSL.

Tree, pole beginning 1963' from DER, 42' right of centerline, up to 7642' MSL.

Pole, tree beginning 2831' from DER, 82' right of centerline, up to 66' AGL/7644' MSL.

Pole 3575' from DER, 309' right of centerline, 59' AGL/7652' MSL.

Transmission line, pole, tree beginning 3576' from DER, 64' right of centerline, up to 70' AGL/7664' MSL.

CONT

09 SEP 2021 to 07 OCT 2021

09 SEP 2021 to 07 OCT 2021



TAKEOFF MINIMUMS, (OBSTACLE) DEPARTURE PROCEDURES, AND DIVERSE VECTOR AREA (RADAR VECTORS)



21224

SW-1



TAKEOFF MINIMUMS, (OBSTACLE) DEPARTURE PROCEDURES, AND DIVERSE VECTOR AREA (RADAR VECTORS)



21224

SALIDA, CO (CON'T)

SALIDA AIRPORT HARRIET ALEXANDER FIELD (ANK) (CON'T)

Rwy 24 (CON'T), transmission line, pole, tree beginning 4197' from DER, 86' right of centerline, up to 74' AGL/7666' MSL.

Pole beginning 5110' from DER, 1319' right of centerline, up to 37' AGL/7667' MSL.

Building, pole beginning 5235' from DER, 553' right of centerline, up to 42' AGL/7675' MSL.

Pole, tree beginning 5455' from DER, 394' right of centerline, up to 38' AGL/7676' MSL.

Pole, tree beginning 5575' from DER, 714' right of centerline, up to 36' AGL/7678' MSL.

Trees beginning 5849' from DER, 904' right of centerline, up to 7679' MSL.

Tree, pole beginning 1.2 NM from DER, 2180' right of centerline, up to 7741' MSL.

Pole, tree beginning 1.2 NM from DER, 2210' right of centerline, up to 39' AGL/7742' MSL.

Trees beginning 1.3 NM from DER, 2557' right of centerline, up to 7746' MSL.

Tree 1.4 NM from DER, 2760' right of centerline, 7749' MSL.

Tree 1.4 NM from DER, 2837' right of centerline, 7752' MSL.

Trees beginning 1.5 NM from DER, 2162' right of centerline, up to 7764' MSL.

Pole, tree beginning 1.5 NM from DER, 965' right of centerline, up to 54' AGL/7769' MSL.

Trees beginning 1.5 NM from DER, 2207' right of centerline, up to 7775' MSL.

Pole 1.6 NM from DER, 1980' right of centerline, 36' AGL/7776' MSL.

Pole, tree beginning 1.6 NM from DER, 1760' right of centerline, up to 37' AGL/7779' MSL.

Pole 1.6 NM from DER, 1545' right of centerline, 36' AGL/7781' MSL.

Pole, tree beginning 1.6 NM from DER, 1323' right of centerline, up to 38' AGL/7784' MSL.

Pole, tree beginning 1.6 NM from DER, 1168' right of centerline, up to 50' AGL/7791' MSL.

Pole, tree beginning 1.6 NM from DER, 2193' right of centerline, up to 33' AGL/7792' MSL.

Pole 1.7 NM from DER, 2599' right of centerline, 35' AGL/7801' MSL.

Poles beginning 1.7 NM from DER, 1370' right of centerline, up to 34' AGL/7803' MSL.

Pole 1.7 NM from DER, 2741' right of centerline, 33' AGL/7805' MSL.

Pole 1.8 NM from DER, 2828' right of centerline, 37' AGL/7812' MSL.

Poles beginning 1.8 NM from DER, 1582' right of centerline, up to 51' AGL/7817' MSL.

Pole 1.9 NM from DER, 2968' right of centerline, 36' AGL/7819' MSL.

Pole 1.9 NM from DER, 2372' right of centerline, 38' AGL/7823' MSL.

Pole 1.9 NM from DER, 1791' right of centerline, 56' AGL/7831' MSL.

Pole 2 NM from DER, 2750' right of centerline, 41' AGL/7832' MSL.

Tree 2.1 NM from DER, 4041' right of centerline, 100' AGL/7825' MSL.

Tree 2.3 NM from DER, 4034' left of centerline, 100' AGL/7783' MSL.

Trees beginning 2.3 NM from DER, 4023' right of centerline, up to 100' AGL/7832' MSL.

Tree 2.3 NM from DER, 4242' left of centerline, 100' AGL/7825' MSL.

Tree 2.4 NM from DER, 4163' left of centerline, 100' AGL/7832' MSL.

Tree 2.4 NM from DER, 4083' left of centerline, 100' AGL/7852' MSL.

Trees beginning 2.4 NM from DER, 4004' left of centerline, up to 100' AGL/7891' MSL.

Trees beginning 2.4 NM from DER, 4102' right of centerline, up to 100' AGL/7835' MSL.

Trees beginning 2.4 NM from DER, 3959' left of centerline, up to 100' AGL/7920' MSL.

SANTA FE, NM

SANTA FE MUNI (SAF)

TAKEOFF MINIMUMS AND (OBSTACLE) DEPARTURE PROCEDURES

AMDT 4A 24MAY18 (18144) (FAA)

TAKEOFF MINIMUMS:

Rwy 2, std. w/min. climb of 295' per NM to 9000.

Rwy 28, std. w/min. climb of 280' per NM to 7800.

DEPARTURE PROCEDURE:

Rwy 2, 10, 33, Climbing right turn direct SAF VORTAC, thence...

Rwy 15, Climb direct SAF VORTAC, thence...

Rwy 20, 28, Climbing left turn direct SAF VORTAC, thence...

...continue climb in SAF VORTAC holding pattern (hold se, right turns, 332° inbound) to cross SAF VORTAC at or above airway MEA/MCA for direction of flight. Pilots shall notify SAF air traffic control tower or Albuquerque Air Route Traffic Control Center prior to flying this departure procedure.

TAKEOFF OBSTACLE NOTES:

Rwy 10, vehicle on road beginning 7' from DER, on centerline, up to 15' AGL/6308' MSL.

Vehicle on road beginning 172' from DER, 340' left of centerline, up to 15' AGL/6319' MSL.

Rwy 15, vegetation 75' from DER, 212' left of centerline, 15' AGL/6279' MSL.

Rwy 20, tree 85' from DER, 354' left of centerline, 13' AGL/6276' MSL.

Rising terrain 231' from DER, 471' right of centerline, 6282' MSL.

Rwy 28, bush 77' from DER, 479' right of centerline, 6290' MSL.

Pole 1.3 NM from DER, 1166' right of centerline, up to 98' AGL/6496' MSL.

Pole 1.6 NM from DER, 2549' left of centerline, 78' AGL/6561' MSL.

09 SEP 2021 to 07 OCT 2021

09 SEP 2021 to 07 OCT 2021



TAKEOFF MINIMUMS, (OBSTACLE) DEPARTURE PROCEDURES, AND DIVERSE VECTOR AREA (RADAR VECTORS)



21224

SW-1



TAKEOFF MINIMUMS, (OBSTACLE) DEPARTURE PROCEDURES, AND DIVERSE VECTOR AREA (RADAR VECTORS)



21224

SANTA TERESA, NM

DONA ANA COUNTY INTL JETPORT (DNA)

TAKEOFF MINIMUMS AND (OBSTACLE) DEPARTURE PROCEDURES

ORIG-B 22JUN17 (17173) (FAA)

TAKEOFF MINIMUMS:

Rwy 10, std. with a min. climb of 430' per NM to 8500, or 2800-3 for VCOA.

Rwy 28, std. with a min. climb of 365' per NM to 8300, or 2800-3 for VCOA.

VCOA:

Rwys 10, 28, obtain ATC approval for VCOA when requesting IFR clearance. Climb in visual conditions to cross Dona Ana County Intl Jetport at or above 6800 before proceeding on course.

TAKEOFF OBSTACLE NOTES:

Rwy 10, bushes and light support structure beginning 6' from DER, 29' left of centerline, up to 7' AGL/4115' MSL.

Light support structure 9' from DER, 30' right of centerline, 1' AGL/4111' MSL.

Bush 159' from DER, 518' right of centerline, 4115' MSL.

Rwy 28, light support structure 9' from DER, 29' right of centerline, 4112' MSL.

Sign 31' from DER, 250' left of centerline, 4113' MSL.

Railroad 1335' from DER, 837' left of centerline, 23' AGL/4148' MSL.

SILVER CITY, NM

GRANT COUNTY (SVC)

TAKEOFF MINIMUMS AND (OBSTACLE) DEPARTURE PROCEDURES

AMDT 2 29MAY14 (14149) (FAA)

TAKEOFF MINIMUMS:

Rwys 3,12,17,21,30,35, NA-Environmental.

DEPARTURE PROCEDURE:

Rwys 8, 26, use SILVER CITY DEPARTURE.

SOCORRO, NM

SOCORRO MUNI (ONM)

TAKEOFF MINIMUMS AND (OBSTACLE) DEPARTURE PROCEDURES

AMDT 3 27AUG09 (09239) (FAA)

TAKEOFF MINIMUMS:

Rwys 6,15,24, NA-terrain.

Rwy 33, 200-1¼ or std. w/ min. climb of 216' per NM to 5100, or alternatively, with standard TAKEOFF minimums and a normal 200'/NM climb gradient, TAKEOFF must occur no later than 1500' prior to DER.

DEPARTURE PROCEDURE:

Rwy 33, climbing right turn via heading 030° and ONM VORTAC R-179 to ONM VORTAC, continue climb-in-hold (hold North, right turns, 182° inbound) to cross ONM VORTAC at or above MEA/MCA for direction of flight.

TAKEOFF OBSTACLE NOTES:

Rwy 33, trees beginning 67' from DER, 66' left of centerline, up to 15' AGL/4814' MSL.

Trees beginning 436' from DER, 438' right of centerline, up to 15' AGL/4814' MSL.

Tower 4996' from DER, 1161' left of centerline, 147' AGL/4947' MSL.

Tower 5851' from DER, 584' right of centerline, 200' AGL/4956' MSL.

SPRINGFIELD, CO

SPRINGFIELD MUNI (8V7)

TAKEOFF MINIMUMS AND (OBSTACLE) DEPARTURE PROCEDURES

ORIG-A 24MAY18 (18144) (FAA)

TAKEOFF MINIMUMS:

Rwy 17, 500-3 or std. w/ min. climb of 220' per NM to 5000.

TAKEOFF OBSTACLE NOTES:

Rwy 17, terrain 2' from DER, 148' right of centerline, 4388' MSL.

Pole, vertical point beginning 9' from DER, 9' left of centerline, up to 4390' MSL.

Fence 17' from DER, 445' right of centerline, 3' AGL/4396' MSL.

Vehicle on road, terrain beginning 134' from DER, 494' right of centerline, up to 4410' MSL.

Poles, tank beginning 403' from DER, 581' right of centerline, up to 30' AGL/4425' MSL.

Antenna 2.5 NM from DER, 2924' right of centerline, up to 30' AGL/4425' MSL.

Tower 2.5 NM from DER, 2923' right of centerline, 417' AGL/4802' MSL.

Rwy 35, pole 9' from DER, 10' right of centerline, 3' AGL/4392' MSL.

Fence 117' from DER, 446' left of centerline, 3' AGL/4394' MSL.

Vehicle on road 222' from DER, 546' left of centerline, 4408' MSL.

Poles beginning 539' from DER, 622' left of centerline, up to 28' AGL/4420' MSL.

Pole 1195' from DER, 623' left of centerline, 29' AGL/4421' MSL.

09 SEP 2021 to 07 OCT 2021

09 SEP 2021 to 07 OCT 2021



TAKEOFF MINIMUMS, (OBSTACLE) DEPARTURE PROCEDURES, AND DIVERSE VECTOR AREA (RADAR VECTORS)



21224

SW-1



TAKEOFF MINIMUMS, (OBSTACLE) DEPARTURE PROCEDURES, AND DIVERSE VECTOR AREA (RADAR VECTORS)



21224

STEAMBOAT SPRINGS, CO

STEAMBOAT SPRINGS/BOB ADAMS FLD (SBS)

TAKEOFF MINIMUMS AND (OBSTACLE) DEPARTURE PROCEDURES

AMDT 2 30JAN20 (21112) (FAA)

TAKEOFF MINIMUMS:

Rwy 14, std. w/min. climb of 657' per NM to 8900 or 3700-3 for VCOA.

Rwy 32, std. w/min. climb of 519' per NM to 9600 or 3700-3 for VCOA.

DEPARTURE PROCEDURE:

Rwy 14, climbing right turn to 14000 on heading 220°, thence . . .

Rwy 32, climb on heading 323° to 7500, then climbing left turn to 14000 direct BQZ VOR/DME, thence . . .

. . . on BQZ R-172 to SBURG and hold, continue climb-in-hold to 14000 (hold south right turns. 352° inbound).

VCOA:

All Rwys, obtain ATC approval for VCOA when requesting IFR clearance. Climb in visual conditions to cross BQZ VOR/DME at or above 10400, continue climb to 14000 on BQZ R-172 to SBURG INT/BQZ 11.35 DME and hold, continue climb-in-hold to 14000 (hold south, right turns, 352° inbound).

TAKEOFF OBSTACLE NOTES:

Rwy 14, tree 171' from DER, 144' left of centerline, 6887' MSL.

Rwy 32, tree 1.6 NM from DER, 3107' right of centerline, 100' AGL/7169' MSL.

Trees beginning 1.7 NM from DER, 2988' right of centerline, up to 30' AGL/7219' MSL.

STERLING, CO

STERLING MUNI (STK)

TAKEOFF MINIMUMS AND (OBSTACLE) DEPARTURE PROCEDURES

AMDT 1 20SEP12 (12264) (FAA)

TAKEOFF MINIMUMS:

Rwys 4, 22, NA-Environmental.

TAKEOFF OBSTACLE NOTES:

Rwy 15, pole 548' from DER, 441' right of centerline, 30' AGL/4040' MSL.

Rwy 33, multiple buildings, signs beginning 10' from DER, left and right of centerline, up to 16' AGL/4065' MSL.

Wall 192' from DER, 511' left of centerline, 6' AGL/4052' MSL.

Multiple trees beginning 573' from DER, 339' left of centerline, up to 41' AGL/4090' MSL.

TAOS, NM

TAOS RGNL (SKX)

TAKEOFF MINIMUMS AND (OBSTACLE) DEPARTURE PROCEDURES

AMDT 2 07DEC17 (17341) (FAA)

TAKEOFF MINIMUMS:

Rwy 31, std. w/ min. climb of 225' per NM to 8500 or 1100 - 3 for VCOA.

DEPARTURE PROCEDURE:

Rwy 4, climbing left turn to intercept TAS VORTAC R-100 to TAS VORTAC. Do not exceed 240 K until TAS VORTAC. thence . . .

Rwy 13, climbing right turn to intercept TAS VORTAC R-150 to TAS VORTAC. Do not exceed 240 K until TAS VORTAC. thence . . .

Rwy 22, climbing right turn to intercept TAS VORTAC R-150 to TAS VORTAC. Do not exceed 240 K until TAS VORTAC. thence . . .

Rwy 31, climbing left turn to intercept TAS VORTAC R-125 to TAS VORTAC. Do not exceed 240 K until TAS VORTAC. thence . . .

. . . climb in TAS VORTAC holding pattern (hold S, right turn, 353° inbound) expect further clearance to 11700 before proceeding enroute.

VCOA:

Rwy 31, obtain ATC approval for VCOA when requesting IFR clearance. Climb in visual conditions to cross TAOS RGNL Airport at or above 8000, then on TAS R-117 to TAS VORTAC, thence climb in TAS VORTAC holding pattern (hold S, right turn, 353° inbound) to 11700 before proceeding enroute.

TAKEOFF OBSTACLE NOTES:

Rwy 4, wind indicator, pole beginning 122' from DER, 139' right of centerline, up to 15' AGL/7108' MSL.

Road 163' from DER, 512' left of centerline, 7107' MSL.

Road 276' from DER, 512' left of centerline, 7108' MSL.

Pole 387' from DER, 547' left of centerline, 38' AGL/7127' MSL.

Pole, road, building, tree beginning 409' from DER, 307' left of centerline, up to 39' AGL/7131' MSL.

Tree 969' from DER, 358' left of centerline, 29' AGL/7134' MSL.

Pole beginning 1275' from DER, 626' right of centerline, up to 7134' MSL.

Pole 1429' from DER, 486' right of centerline, 31' AGL/7138' MSL.

Pole 1603' from DER, 801' left of centerline, 7141' MSL.

Rwy 22, traverse way 36' from DER, 353' left of centerline, 7062' MSL.

Traverse way 173' from DER, 354' left of centerline, 7061' MSL.

09 SEP 2021 to 07 OCT 2021

09 SEP 2021 to 07 OCT 2021



TAKEOFF MINIMUMS, (OBSTACLE) DEPARTURE PROCEDURES, AND DIVERSE VECTOR AREA (RADAR VECTORS)



21224

SW-1



TAKEOFF MINIMUMS, (OBSTACLE) DEPARTURE PROCEDURES, AND DIVERSE VECTOR AREA (RADAR VECTORS)



21224

TELLURIDE, CO

TELLURIDE RGNL (TEX)

TAKEOFF MINIMUMS AND (OBSTACLE) DEPARTURE PROCEDURES

AMDT 3 15OCT15 (15288) (FAA)

TAKEOFF MINIMUMS:

Rwy 9, NA-obstacles.

Rwy 27, std. w/min. climb of 265' per NM to 10000, or 5400-3 for climb in visual conditions.

DEPARTURE PROCEDURE:

Rwy 27, climb to 12000 on heading 276° and the ETL R-096 to ETL VOR/DME. For aircraft departing V-382 southeast bound, continue climb-in-hold to 14200.

VCOA:

Rwy 27, obtain ATC approval for climb in visual conditions when requesting IFR clearance. Climb in visual conditions to cross Telluride RGNL airport westbound or above 14300 then proceed on ETL R-096 to ETL VOR/DME.

TAKEOFF OBSTACLE NOTES:

Rwy 27, terrain 174' from DER, 335' left of centerline, 9090' MSL.

Terrain 286' from DER, 288' left of centerline, 9076' MSL.

Fence 32' from DER, 430' left of centerline, 10' AGL/9106' MSL.

Fence 154' from DER, 423' right of centerline, 15' AGL/9068' MSL.

Fence 292' from DER, 422' right of centerline, 18' AGL/9065' MSL.

Tree 32' from DER, 420' left of centerline, 72' AGL/9111' MSL.

Tree 67' from DER, 495' left of centerline, 88' AGL/9126' MSL.

Tree 70' from DER, 498' left of centerline, 86' AGL/9124' MSL.

Tree 77' from DER, 415' left of centerline, 73' AGL/9111' MSL.

Tree 173' from DER, 530' right of centerline, 41' AGL/9079' MSL.

Tree 234' from DER, 385' left of centerline, 55' AGL/9093' MSL.

Tree 385' from DER, 380' right of centerline, 56' AGL/9094' MSL.

Tree 431' from DER, 266' right of centerline, 50' AGL/9088' MSL.

TRINIDAD, CO

PERRY STOKES (TAD)

TAKEOFF MINIMUMS AND (OBSTACLE) DEPARTURE PROCEDURES

AMDT 5 15SEP16 (16259) (FAA)

DEPARTURE PROCEDURE:

Use TRINIDAD RNAV DEPARTURE.

TRUTH OR CONSEQUENCES, NM

TRUTH OR CONSEQUENCES MUNI (TCS)

TAKEOFF MINIMUMS AND (OBSTACLE) DEPARTURE PROCEDURES

AMDT 2 25APR19 (19115) (FAA)

TAKEOFF MINIMUMS:

Rwys 1, 7, 11, 13, 15, 19, 25, 29, 31, 33, std. w/min. climb of 370' per NM to 13000 or 3700-3 for VCOA.

VCOA:

Rwys 1, 7, 11, 13, 15, 19, 25, 29, 31, 33, obtain ATC approval for VCOA when requesting IFR clearance. Climb in visual conditions to cross Truth or Consequences Muni airport at or above 8400 before proceeding on course.

TAKEOFF OBSTACLE NOTES:

Rwy 7, tree 196' from DER, 47' left of centerline, 4823' MSL.

Rwy 13, fence 39' from DER, 342' left of centerline, 7' AGL/4796' MSL.

Vegetation 65' from DER, 115' left of centerline, 4809' MSL.

Rwy 31, vegetation 57' from DER, 399' left of centerline, 4861' MSL.

Vegetation 170' from DER, 519' left of centerline, 4866' MSL.

Rwy 33, tower 527' from DER, 553' left of centerline, 66' AGL/4895' MSL.

TUCUMCARI, NM

TUCUMCARI MUNI (TCC)

TAKEOFF MINIMUMS AND (OBSTACLE) DEPARTURE PROCEDURES

AMDT 2B 08NOV18 (18312) (FAA)

DEPARTURE PROCEDURE:

Rwy 21, climb on heading 208° until 5500 before turning right.

Rwy 26, climb on heading 258° until 5500 before turning left.

TAKEOFF OBSTACLE NOTES:

Rwy 3, tree 98' from DER, 486' left of centerline, 4067' MSL.

Tree 308' from DER, 499' left of centerline, 4072' MSL.

Tree 354' from DER, 569' left of centerline, 4073' MSL.

Tree 371' from DER, 485' left of centerline, 4087' MSL.

Rwy 8, terrain 24' from DER, 331' left of centerline, 4040' MSL.

Rwy 21, electrical system 7' from DER, 60' right of centerline, 3' AGL/4041' MSL.

Vehicles on road 425' from DER, crossing centerline, 15' AGL/4055' MSL.

Transmission line, pole beginning 494' from DER, 469' left of centerline, up to 34' AGL/4067' MSL.

Rwy 26, vehicles on road 558' from DER, crossing centerline, 15' AGL/4079' MSL.

Tree 595' from DER, 344' right of centerline, 4102' MSL.

Tree 847' from DER, 578' right of centerline, 4114' MSL.



TAKEOFF MINIMUMS, (OBSTACLE) DEPARTURE PROCEDURES, AND DIVERSE VECTOR AREA (RADAR VECTORS)



21224

SW-1



TAKEOFF MINIMUMS, (OBSTACLE) DEPARTURE PROCEDURES, AND DIVERSE VECTOR AREA (RADAR VECTORS)



21224

WALDEN, CO

WALDEN-JACKSON COUNTY (33V)

TAKEOFF MINIMUMS AND (OBSTACLE) DEPARTURE PROCEDURES

ORIG 05JUN08 (08157) (FAA)

TAKEOFF MINIMUMS:

Rwys 17, 35, NA-ATC.

DEPARTURE PROCEDURE:

Rwys 4, 22, Use WALRU RNAV DEPARTURE.

WALSENBURG, CO

SPANISH PEAKS AIRFIELD (4V1)

TAKEOFF MINIMUMS AND (OBSTACLE) DEPARTURE PROCEDURES

ORIG 07MAR13 (13066) (FAA)

DEPARTURE PROCEDURE:

Use GOSIP RNAV DEPARTURE.

WRAY, CO

WRAY MUNI (2V5)

TAKEOFF MINIMUMS AND (OBSTACLE) DEPARTURE PROCEDURES

ORIG 20MAR03 (03079) (FAA)

TAKEOFF MINIMUMS:

Rwy 17, 500-2 or std. with a min. climb of 280' per NM to 4400.

DEPARTURE PROCEDURE:

Rwy 17, climbing right turn via AKO VOR/DME R-084 to 7000 before proceeding on course.

Rwy 35, climbing left turn via AKO VOR/DME R-077 to 7000 before proceeding on course.

TAKEOFF OBSTACLE NOTES:

Rwy 35, trees 2175' left of DER, 100' AGL/3778' MSL.

YUMA, CO

YUMA MUNI (2V6)

TAKEOFF MINIMUMS AND (OBSTACLE) DEPARTURE PROCEDURES

ORIG 24MAY18 (18144) (FAA)

TAKEOFF MINIMUMS:

Rwys 12, 30, NA - airport.

Rwy 34, 200-1 1/8 or std. w/ min. climb of 240' per NM to 4400.

TAKEOFF OBSTACLE NOTES:

Rwy 16, terrain and lighting beginning 15' from DER, 111' right of centerline, up to 4134' MSL.

Rwy 34, terrain and sign beginning 13' from DER, 199' left of centerline, up to 4132' MSL.

Trees beginning 845' from DER, 525' left of centerline, up to 4172' MSL.

Grain elevator 2298' from DER, 821' right of centerline, 87' AGL/4216' MSL.

Tree 2871' from DER, 1198' left of centerline, 4205' MSL.

Building 5750' from DER, 830' left of centerline, 172' AGL/4302' MSL.

09 SEP 2021 to 07 OCT 2021

09 SEP 2021 to 07 OCT 2021



TAKEOFF MINIMUMS, (OBSTACLE) DEPARTURE PROCEDURES, AND DIVERSE VECTOR AREA (RADAR VECTORS)



21224

SW-1