

WAAS CH 86843 W10A	APP CRS 102°	Rwy Idg TDZE 128 Apt Elev 128	3499
--	------------------------	---	-------------

RNAV (GPS) RWY 10

PRINCETON (39N)

RNP APCH - GPS.	MISSED APPROACH: Climb to 2700 direct JETOR and hold.
<p>▼ Rwy 10 helicopter visibility reduction below 3/4 SM NA. Circling Rwy 28 NA at night.</p> <p>▲ NA Baro-VNAV NA. Use Trenton altimeter setting.</p>	

TTN ASOS 126.775	NEW YORK APP CON 132.8 379.9	UNICOM 122.725 (CTAF)	123.05 0
----------------------------	--	---------------------------------	-----------------

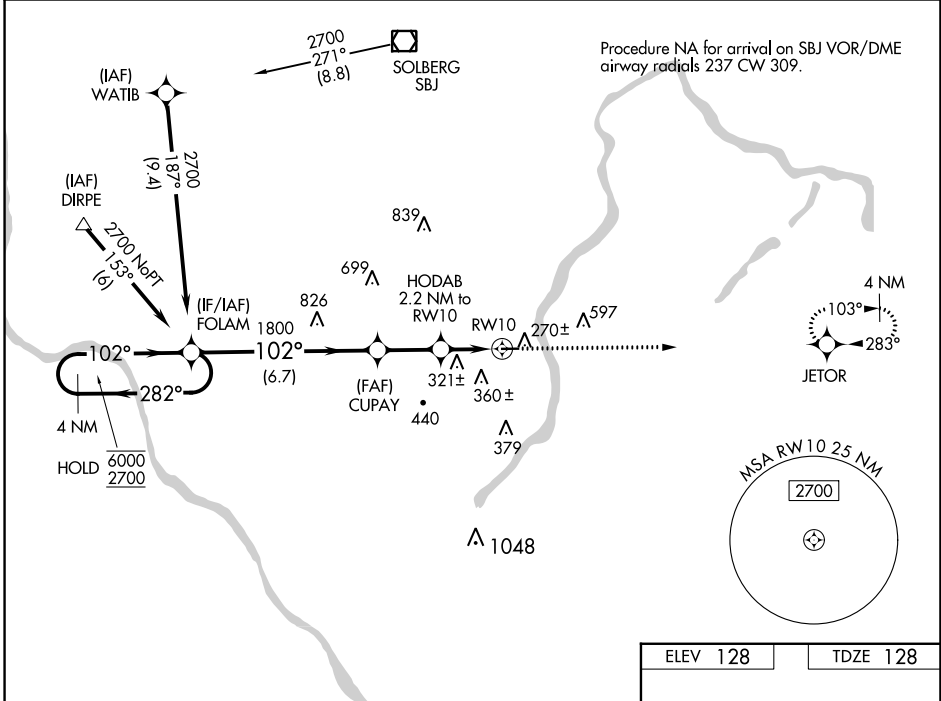

NE-2, 22 FEB 2024 to 21 MAR 2024

NE-2, 22 FEB 2024 to 21 MAR 2024

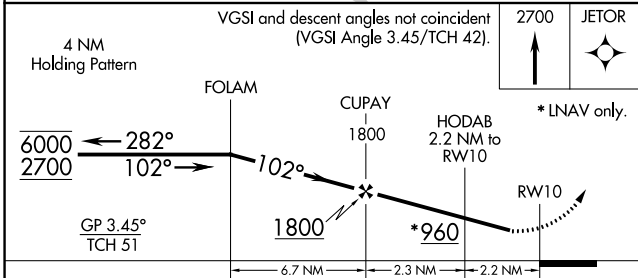

ELEV 128	TDZE 128
----------	----------

CATEGORY	A	B	C	D
LPV DA		441-1	313 (400-1)	
RNAV/VNAV DA		533-1 1/8	405 (500-1 1/8)	
RNAV MDA	580-1	452 (500-1)	580-1 3/8	452 (500-1 3/8)
CIRCLING	760-1 632 (700-1)	840-1 712 (800-1)	940-2 1/2 812 (900-2 1/2)	1000-2 3/4 872 (900-2 3/4)

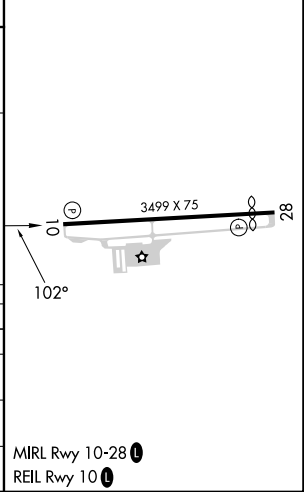

RNAV (GPS) RWY 28

PRINCETON (39N)

APP CRS 282°	Rwy Idg TDZE Apt Elev	3130 128 128
------------------------	-----------------------------	---

RNP APCH.	<p>▼ Use Trenton Mercer altimeter setting, if not received use Somerset altimeter setting. Procedure NA at night. Rwy 28 helicopter visibility reduction below 1 SM NA.</p> <p>▲ NA MISSED APPROACH: Climb to 2700 direct FOLAM and hold.</p>
-----------	---

TTN ASOS 126.775	NEW YORK APP CON 132.8 379.9	UNICOM 122.725 (CTAF)	123.05 0
----------------------------	--	---------------------------------	-----------------

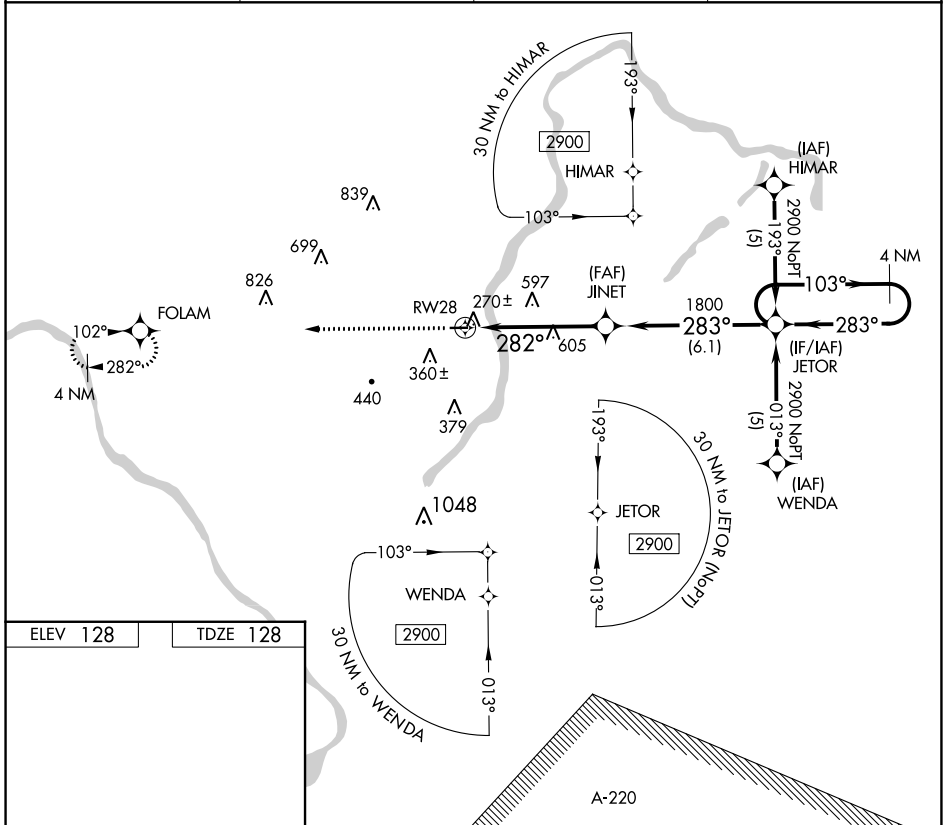

ELEV 128	TDZE 128
----------	----------

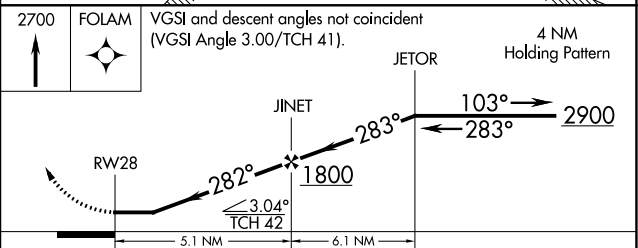

CATEGORY	A	B	C	D
RNAV MDA	900-1 772 (800-1)	900-1¼ 772 (800-1¼)	900-2¼ 772 (800-2¼)	NA

NE-2, 22 FEB 2024 to 21 MAR 2024

NE-2, 22 FEB 2024 to 21 MAR 2024

VOR/DME SBJ 112.9 Chan 76	APP CRS 171°	Rwy Idg TDZE Apt Elev 128	N/A N/A 128
---	------------------------	---	--

VOR-A
PRINCETON (39N)

DME required.	MISSED APPROACH: Climbing left turn to 2300 direct SBJ VOR/DME and hold.
---------------	--

TTN ASOS 126.775	NEW YORK APP CON 132.8 379.9	UNICOM 122.725 (CTAF)	123.05 0
----------------------------	--	---------------------------------	-----------------

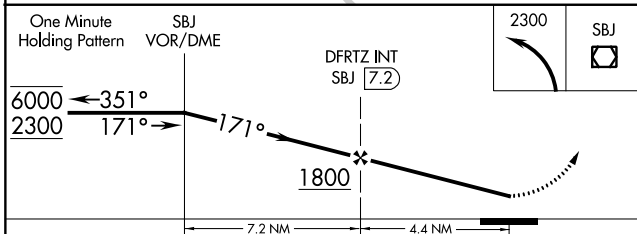
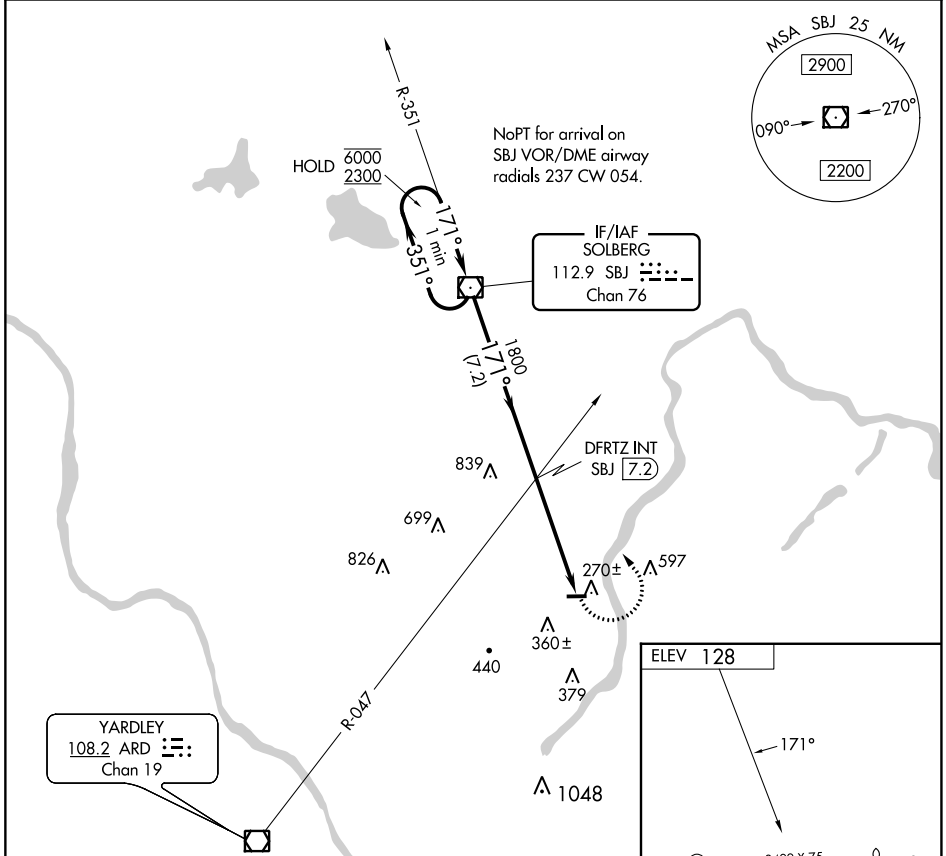

ELEV 128	171°
MRL Rwy 10-28	REIL Rwy 10
FAF to MAP 4.4 NM	
Knots	60 90 120 150 180
Min:Sec	4:24 2:56 2:12 1:46 1:28

CATEGORY	A	B	C	D
CIRCLING	1040-1¼	912 (1000-1¼)	NA	

NE-2, 22 FEB 2024 to 21 MAR 2024

NE-2, 22 FEB 2024 to 21 MAR 2024