

AIRPORT DIAGRAM

AL-432 (FAA)

TULSA INTL (TUL)
TULSA, OKLAHOMA

D-ATIS
124.9 377.2
TULSA TOWER
121.2 310.8 (RWYS 18L-36R, 08-26)
118.7 257.8 (RWY 18R-36L)
GND CON
121.9 348.6
CLNC DEL
134.05 284.7
PDC
D

JANUARY 2020
ANNUAL RATE OF CHANGE
0.1° W

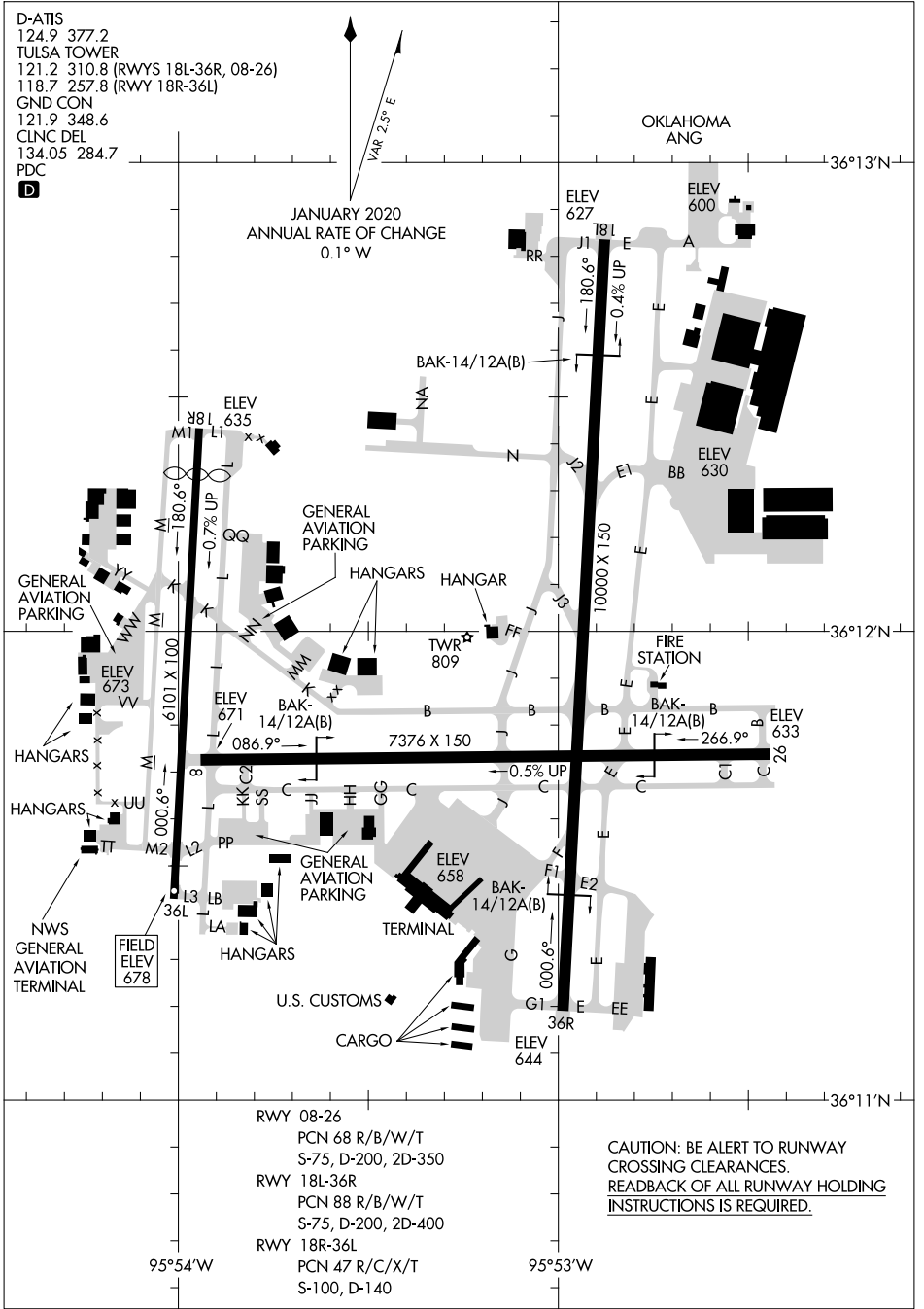

SC-1, 22 FEB 2024 to 21 MAR 2024

SC-1, 22 FEB 2024 to 21 MAR 2024

RWY 08-26
PCN 68 R/B/W/T
S-75, D-200, 2D-350

RWY 18L-36R
PCN 88 R/B/W/T
S-75, D-200, 2D-400

RWY 18R-36L
PCN 47 R/C/X/T
S-100, D-140

CAUTION: BE ALERT TO RUNWAY CROSSING CLEARANCES. READBACK OF ALL RUNWAY HOLDING INSTRUCTIONS IS REQUIRED.

AIRPORT DIAGRAM

TULSA, OKLAHOMA
TULSA INTL (TUL)

(TUL9.TUL) 24025

AL-432 (FAA)

TULSA INTL (TUL)
TULSA, OKLAHOMA

TULSA NINE DEPARTURE

D-ATIS

124.9 377.2

TULSA TOWER

118.7 257.8 (Rwy 18R-36L)

121.2 310.8 (Rwys 18L-36R, 8-26)

CLNC DEL

134.05 284.7

TULSA DEP CON

124.0 338.3

TOP ALTITUDE:
15000

CHANUTE
109.2 CNU Chan 29

FARMINGTON
115.7 FAM Chan 104

SPRINGFIELD
116.9 SGF Chan 116

BARTLESVILLE
117.9 BVO Chan 126

RAZORBACK
116.4 RZC Chan 111

WILL ROGERS
114.1 IRW Chan 88

TULSA
114.4 TUL Chan 91

FORT SMITH
110.4 FSM Chan 41

ARDMORE
116.7 ADM Chan 114

MAVERICK
113.1 TTT Chan 78

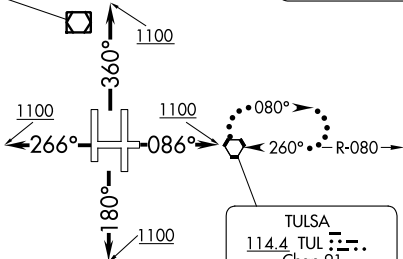

TAKEOFF MINIMUMS

Rwys 8, 18L/R, 36L/R: Standard.
Rwy 26: Standard with minimum
climb of 225' per NM to 2900.

NOTE: Chart not to scale.



DEPARTURE ROUTE DESCRIPTION

TAKEOFF RUNWAYS 18L/R: Climb on heading 180° to 1100, thence. . .

TAKEOFF RUNWAYS 36L/R: Climb on heading 360° to 1100, thence. . .

TAKEOFF RUNWAY 8: Climb on heading 086° to 1100, thence. . .

TAKEOFF RUNWAY 26: Climb on heading 266° to 1100, thence. . .

. . . continue on assigned heading for RADAR vectors to assigned route, maintain 15000 or assigned lower altitude, expect further clearance to filed altitude 10 minutes after departure.

LOST COMMUNICATIONS: Proceed to and hold east of TUL VORTAC on the 080° radial. Climb to 15000 feet or lower requested altitude, then proceed on course on filed route. Climb to requested altitude when established on course.

TULSA NINE DEPARTURE
(TUL9.TUL) 02DEC21

TULSA, OKLAHOMA
TULSA INTL (TUL)

SC-1, 22 FEB 2024 to 21 MAR 2024

SC-1, 22 FEB 2024 to 21 MAR 2024

HI-VOR Z or TACAN Z RWY 26

[USAF]

TULSA INTL (KTUL)

TULSA, OKLAHOMA

VORTAC TUL Chan 91	APCH CRS 262°	Rwy Idg TDZE Appt Elev	7376 652 678
-----------------------	------------------	------------------------------	--------------------

DME required
 **When AIS inop, increase CAT CDE vis to 1 1/4 miles.
 **CAT E circling not authorized S of Rwy 8-26.

AIS 124.9 377.2	APP CON 124.0 338.3 175°-354° 119.1 351.8 355°-174°	TOWER 121.2 310.8 Rwy 18I-36R 8-26 118.7 257.8 Rwy 18R-36I
--------------------	---	--

MAISR A5	MISSED APPROACH: Climbing left turn to 2600 on heading 220° and TUL VORTAC R-238 to KEVIL/TUL 25.4 DME and hold.
-------------	--

GND CON 121.9 348.6	CINC DEL 134.05 284.7	ASR
------------------------	--------------------------	-----

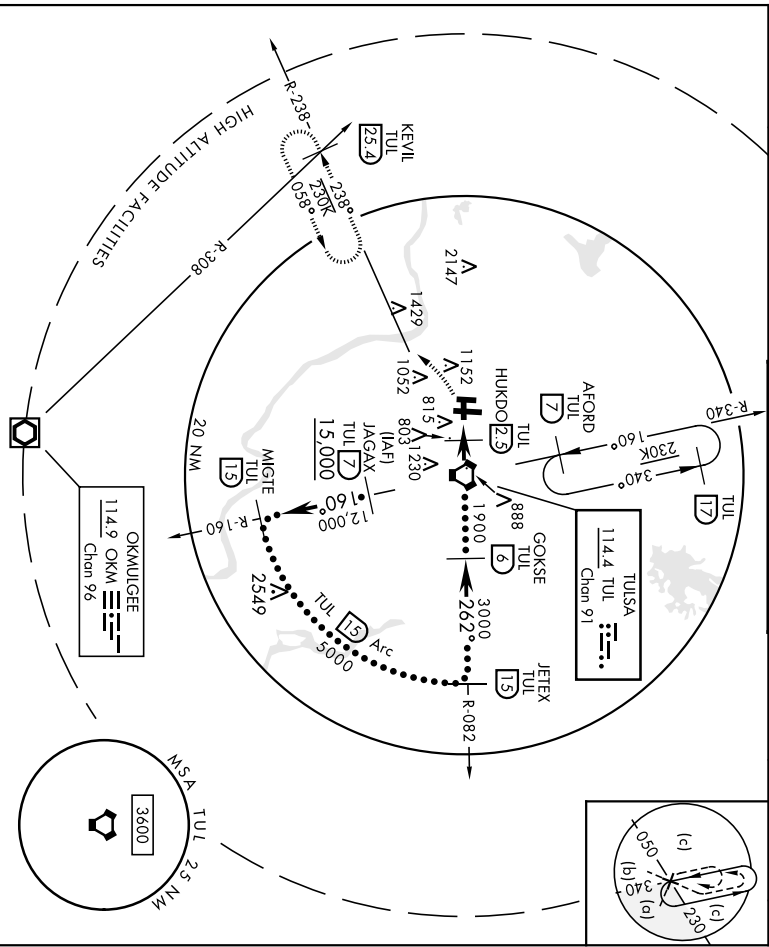

EMERG SAFE ALT 100 NM 4500

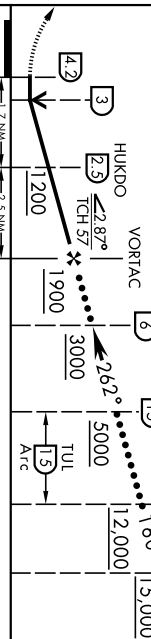

CATEGORY	C	D	E
S-26 *	1080-3/4	428 (500-3/4)	

CIRCLING **	1520-2 1/2 842 (900-2 1/4)	1520-2 3/4 842 (900-2 3/4)	1520-3 842 (900-3)
-------------	-------------------------------	-------------------------------	-----------------------

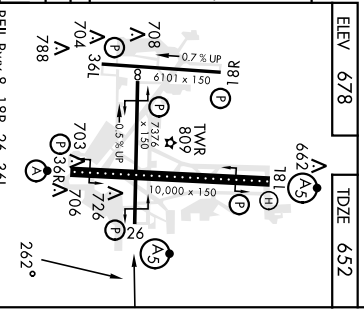

TULSA, OKLAHOMA

Amdt 38 30NOV23

36°12'N 95°53'W

TULSA INTL (KTUL)

HI-VOR Z or TACAN Z RWY 26

LOC/DME I-TUL 110.3 Chan 40	APP CRS 360°	Rwy Idg TDZE Apt Elev 10000 650 678
--	------------------------	---

ILS RWY 36R (CAT II)

TULSA INTL (TUL)

ADF or DME required for procedure entry.	ALSF-2 	MISSED APPROACH: Climb to 2000 then climbing right turn to 2500 direct TUL VORTAC and hold. (TACAN aircraft climb to 2000 then climbing right turn to 3500 via TUL VORTAC R-079 to INOLA INT/17.9 DME and hold E, RT, 259° inbound).
ASR Simultaneous approach authorized.		

D-ATIS 124.9 377.2	TULSA APP CON 124.0 338.3	TULSA TOWER 121.2 310.8 (Rwys 18L-36R, 8-26) 118.7 257.8 (Rwy 18R-36L)	GND CON 121.9 348.6	CLNC DEL 134.05 284.7
------------------------------	-------------------------------------	--	-------------------------------	---------------------------------

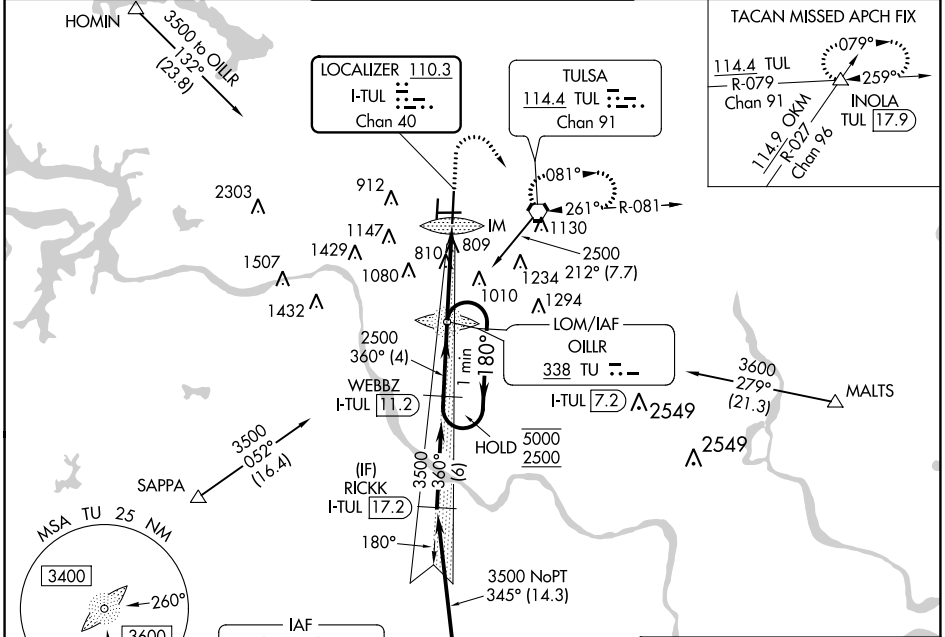

SC-1, 22 FEB 2024 to 21 MAR 2024

SC-1, 22 FEB 2024 to 21 MAR 2024

ELEV 678	D TDZE 650
----------	-------------------

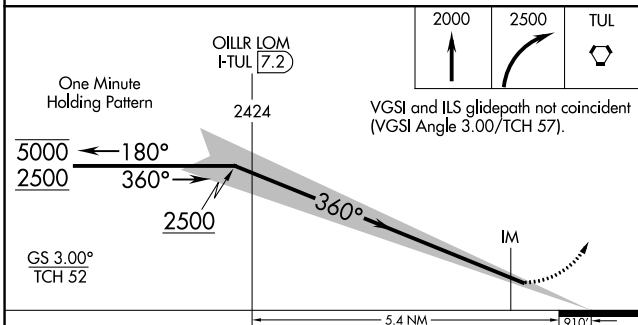

2000	2500	TUL
------	------	-----

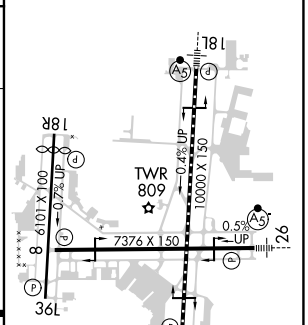

CATEGORY	A	B	C	D
S-ILS 36R	RA 116/12 100 DA 750			

CATEGORY II ILS-SPECIAL AIRCREW & AIRCRAFT CERTIFICATION REQUIRED

TDZ/CL Rwy 36R
HIRL Rwys 8-26, 18L-36R and 18R-36L
REIL Rwys 8, 18R and 36L

LOC/DME I-TUL 110.3 Chan 40	APP CRS 360°	Rwy Idg TDZE 650 Apt Elev 678
---	------------------------	---

ILS RWY 36R (SA CAT I)

TULSA INTL (TUL)

ADF or DME required for procedure entry.	ALSIF-2 	MISSED APPROACH: Climb to 2000 then climbing right turn to 2500 direct TUL VORTAC and hold. (TACAN aircraft climb to 2000 then climbing right turn to 3500 via TUL VORTAC R-079 to INOLA INT/17.9 DME and hold E, RT, 259° inbound).
ASR Simultaneous approach authorized. Requires specific OPSEC, MSPEC, or LOA approval and use of HUD to DH.		

D-ATIS 124.9 377.2	TULSA APP CON 124.0 338.3	TULSA TOWER 121.2 310.8 (Rwys 18L-36R, 8-26) 118.7 257.8 (Rwy 18R-36L)	GND CON 121.9 348.6	CLNC DEL 134.05 284.7
------------------------------	-------------------------------------	--	-------------------------------	---------------------------------

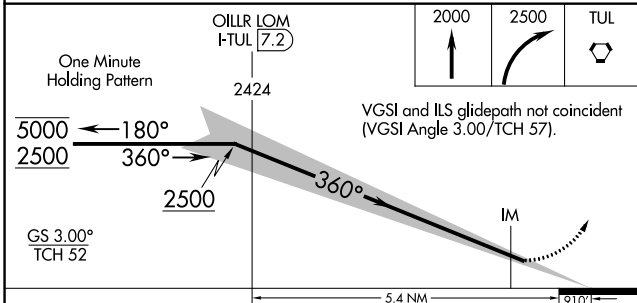
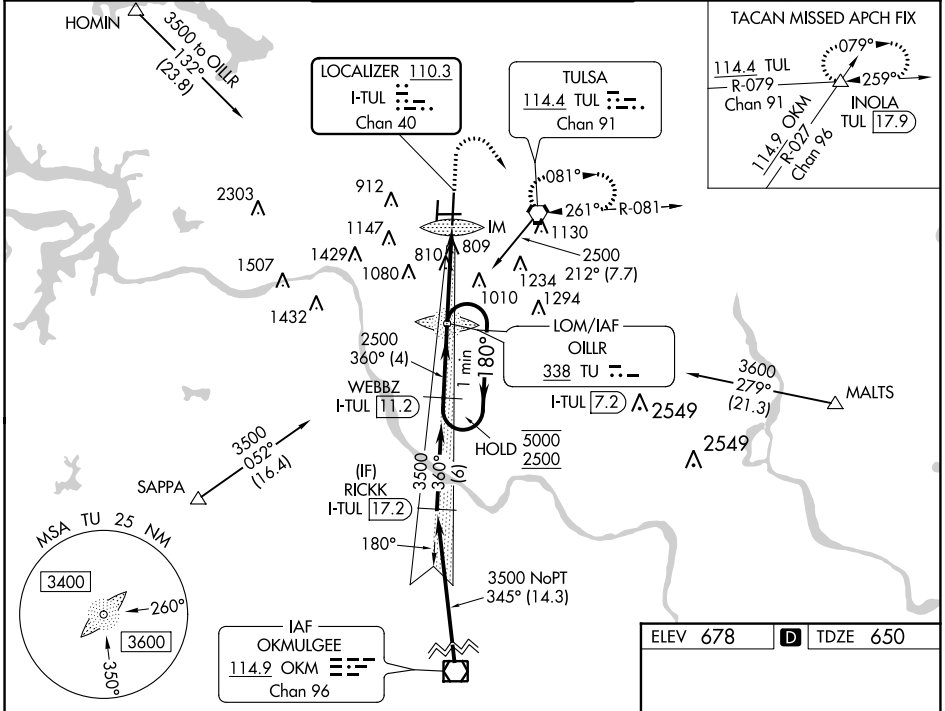

ELEV 678	D TDZE 650
----------	-------------------

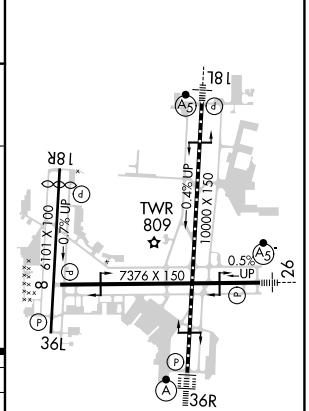

CATEGORY	A	B	C	D
S-ILS 36R		RA 166/14	150	DA 800

SA CATEGORY I ILS-SPECIAL AIRCREW & AIRCRAFT CERTIFICATION REQUIRED

TDZ/CL Rwy 36R
HIRL Rwys 8-26, 18L-36R and 18R-36L
REIL Rwys 8, 18R and 36L

SC-1, 22 FEB 2024 to 21 MAR 2024

SC-1, 22 FEB 2024 to 21 MAR 2024

LOC/DME I-DWE 109.7 Chan 34	APP CRS 180°	Rwy Idg TDZE 641 Apt Elev 678
---	------------------------	---

ILS or LOC RWY 18L

TULSA INTL (TUL)

DME required for LOC only.
DME or RADAR required for procedure entry.

MAJLSR

MISSED APPROACH: Climb to 2000 then climbing left turn to 2500 direct TUL VORTAC and hold, continue climb-in-hold to 2500. (TACAN aircraft climb to 1800 then climbing left turn to 3500 on TUL VORTAC R-079 to INOLA INT/17.9 DME and hold E, RT, 259° inbound).

ASR
 Circling NA for Cat E south of Rwy 8-26. Simultaneous approach authorized with Rwy 18R. Autopilot coupled approach NA below 813 feet. For inop ALS, increase S-ILS 18L Cat E visibility to RVR 4000, S-LOC 18L Cat E visibility to 1/2 SM, and PALIY fix minimums S-LOC 18L Cat E visibility to RVR 4500.
 #RVR 1800 authorized with use of FD or AP or HUD to DA.

D-ATIS 124.9 377.2	TULSA APP CON 124.0 338.3	TULSA TOWER 121.2 310.8 (Rwys 18L-36R, 8-26) 118.7 257.8 (Rwy 18R-36L)	GND CON 121.9 348.6	CLNC DEL 134.05 284.7
------------------------------	-------------------------------------	--	-------------------------------	---------------------------------

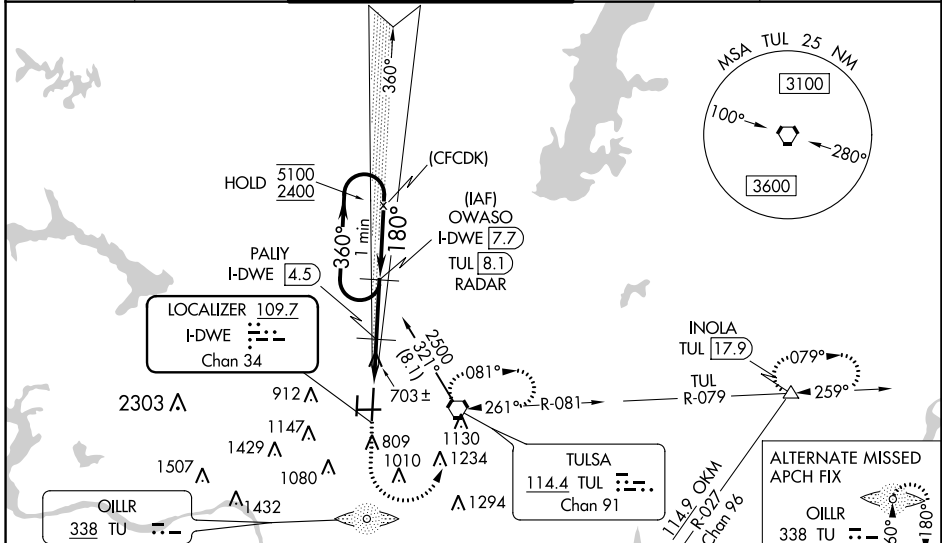

ELEV 678	D	TDZE 641
----------	----------	----------

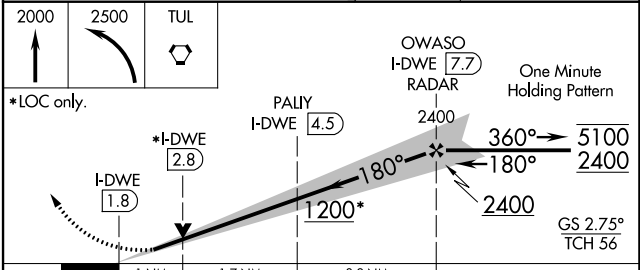
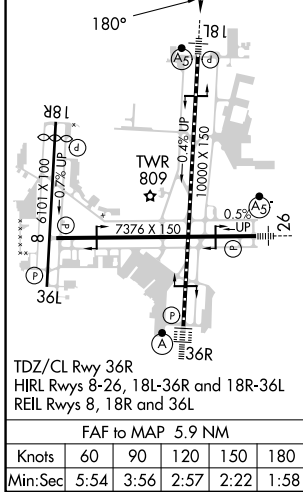

CATEGORY	A	B	C	D	E
S-ILS 18L #	841/24 200 (200-1/2)				
S-LOC 18L	1200/24	559 (600-1/2)	1200/60 559 (600-1/4)		
C CIRCLING	1200-1	522 (600-1)	1520-2 1/2 842 (900-2 1/2)	1520-2 3/4 842 (900-2 3/4)	1520-3 842 (900-3)
PALIY FIX MINIMUMS (DME REQUIRED)					
S-LOC 18L	960/24	319 (300-1/2)	960/40 319 (300-3/4)		
C CIRCLING	1120-1 442 (500-1)	1160-1 482 (500-1)	1520-2 1/2 842 (900-2 1/2)	1520-2 3/4 842 (900-2 3/4)	1520-3 842 (900-3)

SC-1, 22 FEB 2024 to 21 MAR 2024

SC-1, 22 FEB 2024 to 21 MAR 2024

ILS or LOC RWY 18R

TULSA INTL (TUL)

LOC I-TJY 111.1	APP CRS 180°	Rwy Idg TDZE Apt Elev 5501 668 678
---------------------------	------------------------	--

ASR Simultaneous approach authorized. MISSED APPROACH: Climb to 1400 then climbing right turn to 2600 on TUL VORTAC R-238 to KEVIL INT/TUL 25.4 DME and hold.

D-ATIS 124.9 377.2	TULSA APP CON 124.0 338.3	TULSA TOWER 121.2 310.8 (Rwys 18L-36R, 8-26) 118.7 257.8 (Rwy 18R-36L)	GND CON 121.9 348.6	CLNC DEL 134.05 284.7
------------------------------	-------------------------------------	--	-------------------------------	---------------------------------

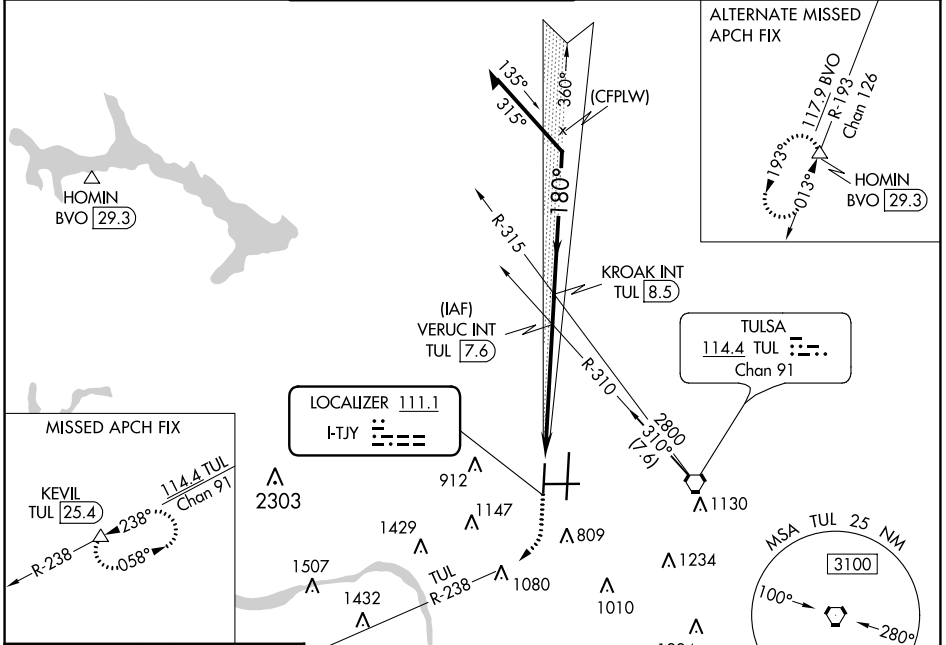

ELEV 678	D	TDZE 668
----------	----------	----------

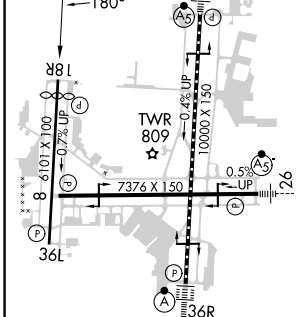

TDZ/CL Rwy 36R
HIRL Rwys 8-26, 18L-36R and 18R-36L
REIL Rwys 8, 18R and 36L

FAF to MAP 6.2 NM

Knots	60	90	120	150	180
Min:Sec	6:12	4:08	3:06	2:29	2:04

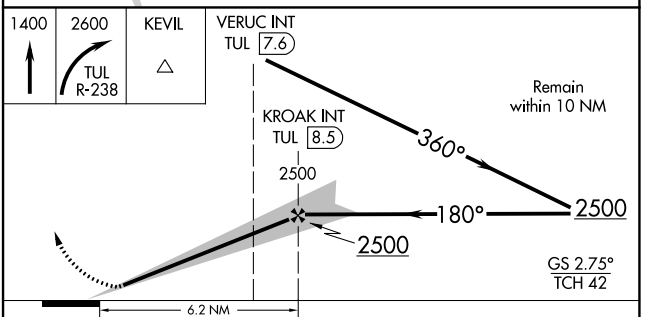

CATEGORY	A	B	C	D
S-ILS 18R		868-3/4	200 (200-3/4)	
S-LOC 18R	1180-1	512 (600-1)	1180-1 3/8 512 (600-1 3/8)	
<input checked="" type="checkbox"/> CIRCLING	1180-1	502 (600-1)	1500-2 1/2 822 (900-2 1/2)	1520-2 3/4 842 (900-2 3/4)

SC-1, 22 FEB 2024 to 21 MAR 2024

SC-1, 22 FEB 2024 to 21 MAR 2024

LOC/DME I-TUL 110.3 Chan 40	APP CRS 360°	Rwy Idg 10000 TDZE 650 Apt Elev 678
---	------------------------	--

ILS or LOC RWY 36R

TULSA INTL (TUL)

ADF or DME required for procedure entry.		ALS-F-2 	MISSED APPROACH: Climb to 2000 then climbing right turn to 2500 direct TUL VORTAC and hold. (TACAN aircraft climb to 2000 then climbing right turn to 3500 via TUL VORTAC R-079 to INOLA INT/17.9 DME and hold E, RT, 259° inbound).
<p>▼ Simultaneous approach authorized. For inop ALS, increase S-ILS 36R Cat E visibility to RVR 4000. For inop ALS, increase S-LOC 36R Cat E visibility to 1/8 SM. YEPUT Fix Minimums: For inop ALS, increase S-LOC 36R Cat C/D/E visibility to RVR 6000. Circling NA for Cat E south of Rwy 8-26.</p> <p>▲ ASR</p>			

D-ATIS 124.9 377.2	TULSA APP CON 124.0 338.3	TULSA TOWER 121.2 310.8 (Rwys 18L-36R, 8-26) 118.7 257.8 (Rwy 18R-36L)	GND CON 121.9 348.6	CLNC DEL 134.05 284.7
------------------------------	-------------------------------------	--	-------------------------------	---------------------------------

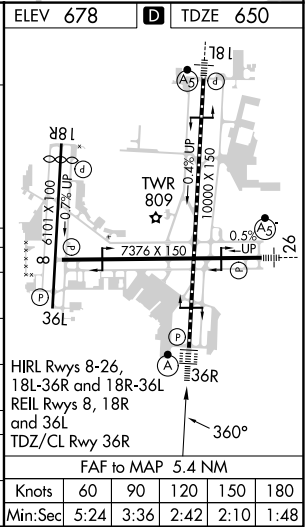
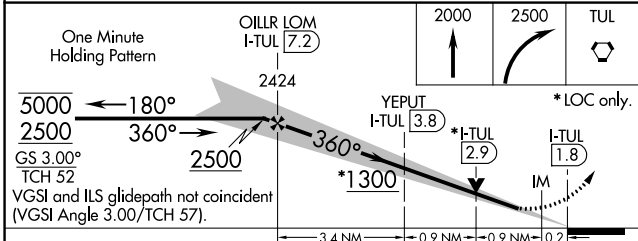
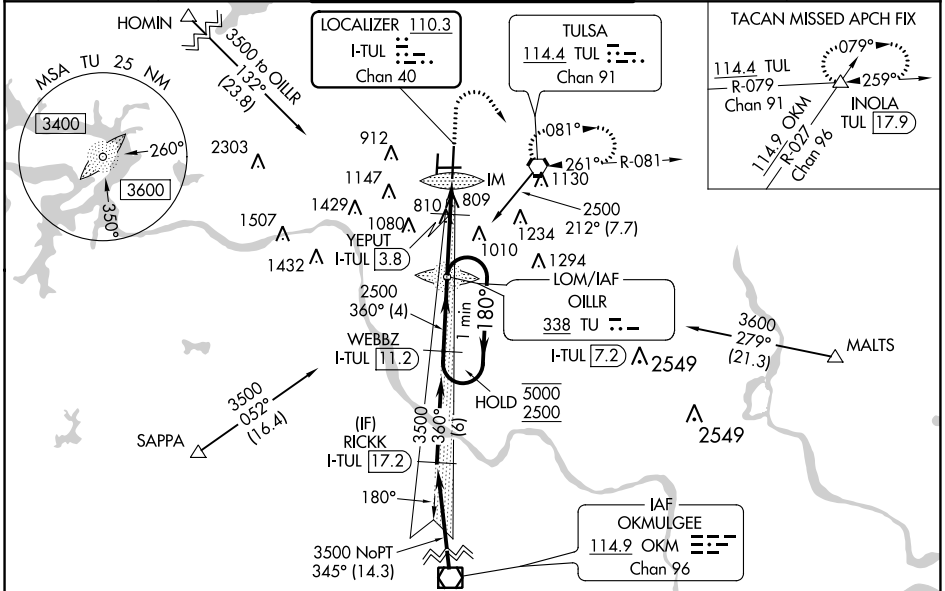

CATEGORY	A	B	C	D	E
S-ILS 36R	850/18		200 (200-1/2)		
S-LOC 36R	1300/24	650 (700-1/2)	1300-1 3/8		650 (700-1 3/8)
C CIRCLING	1300-1	622 (700-1)	1520-2 1/2 842 (900-2 1/2)	1520-2 3/4 842 (900-2 3/4)	1520-3 842 (900-3)
YEPUT FIX MINIMUMS (DME REQUIRED)					
S-LOC 36R	1060/24	410 (400-1/2)	1060/40		410 (400-3/4)
C CIRCLING	1120-1 442 (500-1)	1160-1 482 (500-1)	1520-2 1/2 842 (900-2 1/2)	1520-2 3/4 842 (900-2 3/4)	1520-3 842 (900-3)

FAF to MAP 5.4 NM					
Knots	60	90	120	150	180
Min:Sec	5:24	3:36	2:42	2:10	1:48

SC-1, 22 FEB 2024 to 21 MAR 2024

SC-1, 22 FEB 2024 to 21 MAR 2024

WAAS CH 93504 W18A	APP CRS 180°	Rwy Idg TDZE 641 Apt Elev 678	10000
--	------------------------	---	--------------

RNAV (GPS) RWY 18L

TULSA INTL (TUL)

RNP APCH - GPS.

⚠ Circling NA for Cat E south of Rwy 8-26. Use of FD or AP required during simultaneous operations. For uncompensated Baro-VNAV systems, LNAV/VNAV NA below -11°C or above 54°C. For inop ALS, increase LPV Cat E visibility to RVR 4000, LNAV/VNAV all Cats visibility to RVR 5500, and LNAV Cat E visibility to 1/4 SM. Simultaneous approach authorized. LNAV procedure NA during simultaneous operations.



MISSED APPROACH:
Climb to 3500 direct ICECE and hold.

D-ATIS 124.9 377.2	TULSA APP CON 124.0 338.3	TULSA TOWER 121.2 310.8 (Rwys 18L-36R, 8-26) 118.7 257.8 (Rwy 18R-36L)	GND CON 121.9 348.6	CLNC DEL 134.05 284.7
------------------------------	-------------------------------------	--	-------------------------------	---------------------------------

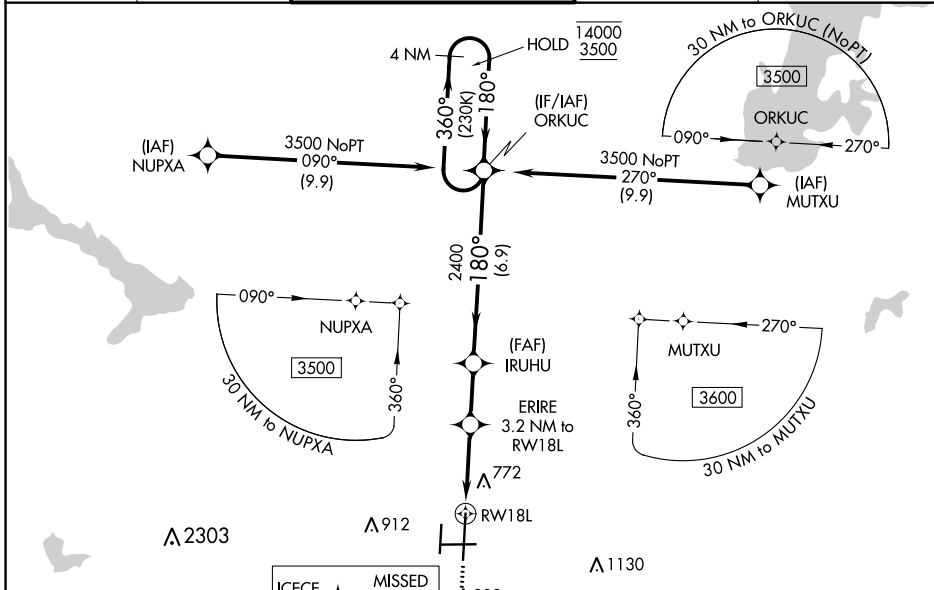

ELEV 678	D TDZE 641
----------	-------------------

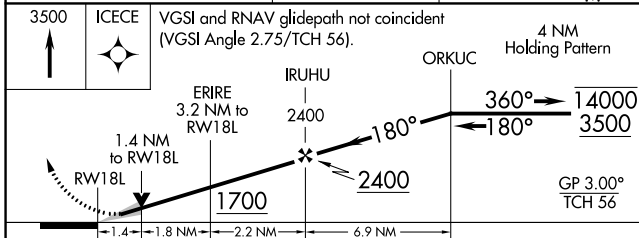

CATEGORY	A	B	C	D	E
LPV DA		841/24	200 (200-1/2)		
LNAV/VNAV DA		983/30	342 (400-5/8)		
LNAV MDA	1080/24	439 (500-1/2)	1080/40	439 (500-3/4)	
C CIRCLING	1120-1 442 (500-1)	1160-1 482 (500-1)	1500-2 1/2 822 (900-2 1/2)	1520-2 3/4 842 (900-2 3/4)	1520-3 842 (900-3)

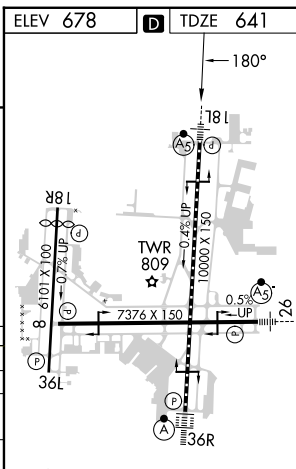

TDZ/CL Rwy 36R
HIRL Rwys 8-26, 18L-36R and 18R-36L
REIL Rwys 8, 18R and 36L

SC-1, 22 FEB 2024 to 21 MAR 2024

SC-1, 22 FEB 2024 to 21 MAR 2024

WAAS CH 93814 W26A	APP CRS 266°	Rwy Idg TDZE Apt Elev	7376 652 678
--	------------------------	-----------------------------	---

RNAV (GPS) RWY 26

TULSA INTL (TUL)

ASR Inop table does not apply to LPV DA. For uncompensated Baro-VNAV systems, LNAV/VNAV NA below -13°C (9°F) or above 54°C (130°F). For inop MALSR, increase LNAV/VNAV DA Cat E visibility to 1½ mile, LNAV MDA Cats A/B visibility to 1 mile and Cat E to 1½ mile. Circling NA for Cat E south of Rwy 8-26. DME/DME RNP-0.3 NA.

MALSR

MISSED APPROACH: Climb to 3500 direct HAGIL and hold.

D-ATIS 124.9 377.2	TULSA APP CON 124.0 338.3	TULSA TOWER 121.2 310.8 (Rwys 18L-36R, 8-26) 118.7 257.8 (Rwy 18R-36L)	GND CON 121.9 348.6	CLNC DEL 134.05 284.7
------------------------------	-------------------------------------	--	-------------------------------	---------------------------------

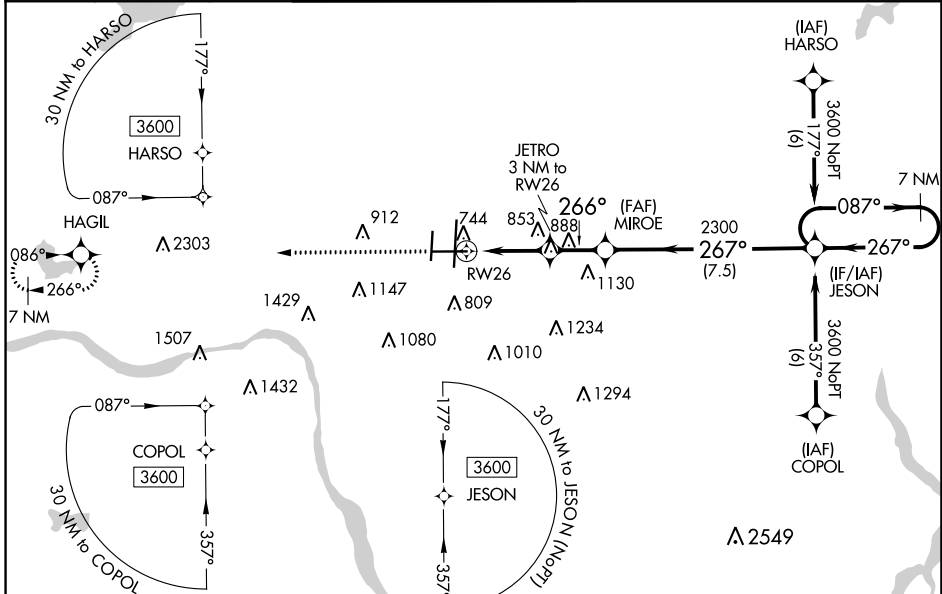

SC-1, 22 FEB 2024 to 21 MAR 2024

SC-1, 22 FEB 2024 to 21 MAR 2024

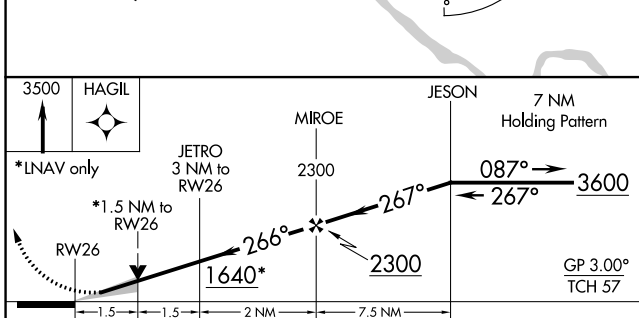

ELEV 678	D TDZE 652
----------	-------------------

CATEGORY	A	B	C	D	E
LPV DA	852-¾ 200 (200-¾)				
LNAV/VNAV DA	1089-1 437 (500-1)				
LNAV MDA	1160-¾ 508 (500-¾)	1160-1 508 (500-1)			
C CIRCLING	1160-1 482 (500-1)	1520-2½ 842 (900-2½)	1520-2¾ 842 (900-2¾)	1520-3 842 (900-3)	

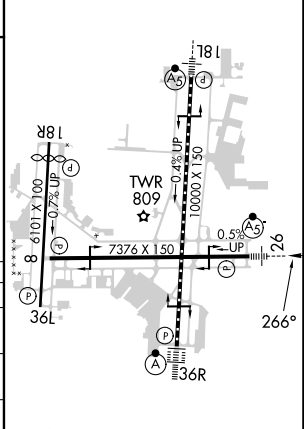

TDZ/CL Rwy 36R
HIRL Rwys 8-26, 18L-36R and 18R-36L
REIL Rwys 8, 18R and 36L

WAAS CH 50344 W36B	APP CRS 360°	Rwy Idg TDZE Apt Elev	5101 678 678
--	------------------------	-----------------------------	---

RNAV (GPS) RWY 36L

TULSA INTL (TUL)

RNP APCH - GPS.		MISSED APPROACH: Climb to 3500 direct AXIWU and hold.	
<p>Use of FD or AP required during simultaneous operations. For uncompensated Baro-VNAV systems, LNAV/VNAV NA below -14°C or above 54°C. Simultaneous approach authorized. LNAV procedure NA during simultaneous operations.</p>			

D-ATIS 124.9 377.2	TULSA APP CON 124.0 338.3	TULSA TOWER 121.2 310.8 (Rwys 18L-36R, 8-26) 118.7 257.8 (Rwy 18R-36L)	GND CON 121.9 348.6	CLNC DEL 134.05 284.7
------------------------------	-------------------------------------	--	-------------------------------	---------------------------------

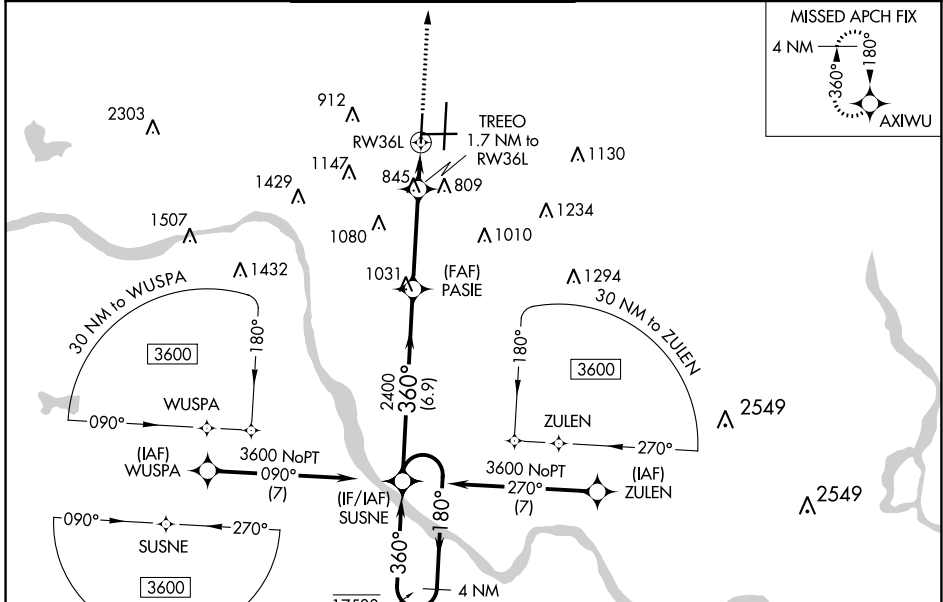

SC-1, 22 FEB 2024 to 21 MAR 2024

SC-1, 22 FEB 2024 to 21 MAR 2024

ELEV 678	D TDZE 678
TDZ/CL Rwy 36R HIRL All Rwys REIL Rwys 8, 18R and 36L	

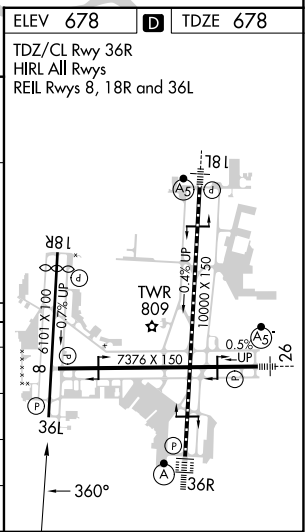
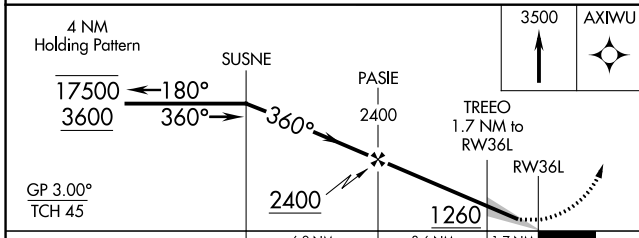

CATEGORY	A	B	C	D
LPV DA		928-3/4	250 (300-3/4)	
LNAV/VNAV DA		1088-1 1/8	410 (500-1 1/8)	
LNAV MDA	1120-1	442 (500-1)	1120-1 3/8	442 (500-1 3/8)
C CIRCLING	1120-1 442 (500-1)	1160-1 482 (500-1)	1500-2 1/2 822 (900-2 1/2)	1520-2 3/4 842 (900-2 3/4)

WAAS CH 82214 W36A	APP CRS 360°	Rwy ldg 10000 TDZE 650 Apt Elev 678
--	------------------------	--

RNAV (GPS) RWY 36R

TULSA INTL (TUL)

For uncompensated Baro-VNAV systems, LNAV/VNAV NA below -13°C (9°F) or above 54°C (130°F). Circling NA for Cat E south of Rwy 8-26. DME/DME RNP-0.3 NA. For inop ALSF-2, increase LPV Cat E visibility to RVR 4000, LNAV/VNAV all Cats visibility to 1½ mile, and LNAV Cats C/D/E visibility to 1½ mile.	ALSF-2 	MISSED APPROACH: Climb to 3500 direct ORKUC and hold.
---	------------	--

D-ATIS 124.9 377.2	TULSA APP CON 124.0 338.3	TULSA TOWER 121.2 310.8 (Rwys 18L-36R, 8-26) 118.7 257.8 (Rwy 18R-36L)	GND CON 121.9 348.6	CLNC DEL 134.05 284.7
------------------------------	-------------------------------------	--	-------------------------------	---------------------------------

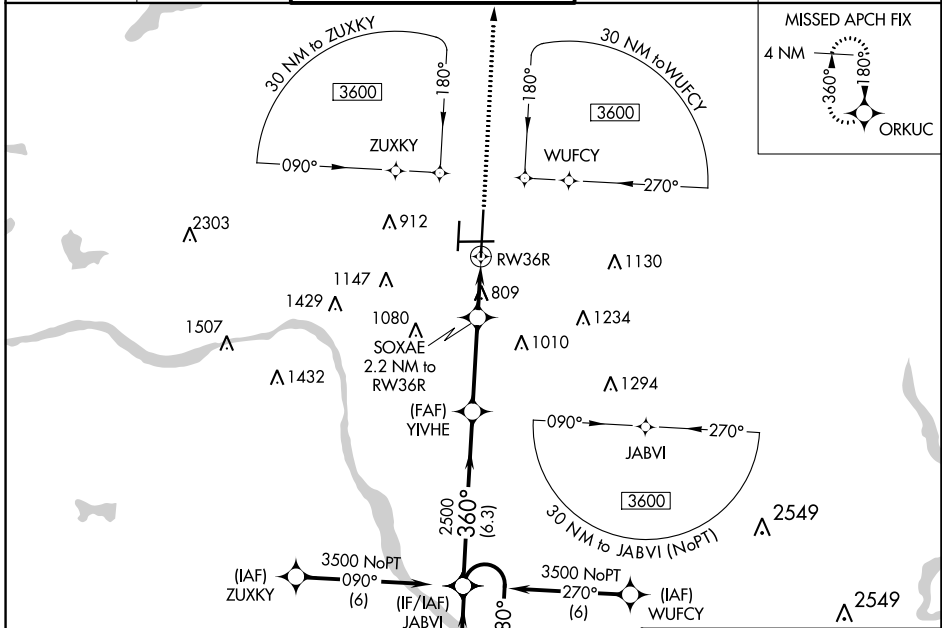

ELEV 678		TDZE 650
----------	--	----------

TDZ/CL Rwy 36R
HIRL Rwys 8-26, 18L-36R and 18R-36L
REIL Rwys 8, 18R and 36L

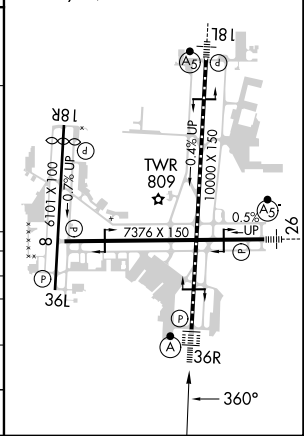
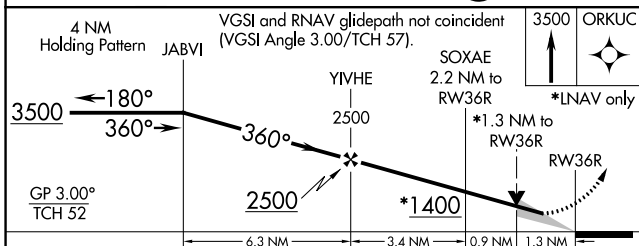

CATEGORY	A	B	C	D	E
LPV DA	850/18		200 (200-½)		
LNAV/VNAV DA	1145-1¼		495 (500-1¼)		
LNAV MDA	1120/24 470 (500-½)		1120/50 470 (500-1)		
CIRCLING	1120-1 442 (500-1)	1160-1 482 (500-1)	1520-2½ 842 (900-2½)	1520-2¾ 842 (900-2¾)	1520-3 842 (900-3)

SC-1, 22 FEB 2024 to 21 MAR 2024

SC-1, 22 FEB 2024 to 21 MAR 2024

WAAS CH 63131 W08A	APP CRS 086°	Rwy Idg 7376 TDZE 671 Apt Elev 678
--	------------------------	---

RNAV (GPS) RWY 8

TULSA INTL (TUL)

RNP APCH.		MISSED APPROACH: Climb to 3600 direct JESON and hold.	
<p>▼ Circling NA for Cat E south of Rwy 8-26. For uncompensated Baro-VNAV systems, LNAV/VNAV NA below -13°C or ASR above 54°C.</p>			

D-ATIS 124.9 377.2	TULSA APP CON 124.0 338.3	TULSA TOWER 121.2 310.8 (Rwys 18L-36R, 8-26) 118.7 257.8 (Rwy 18R-36L)	GND CON 121.9 348.6	CLNC DEL 134.05 284.7
------------------------------	-------------------------------------	--	-------------------------------	---------------------------------

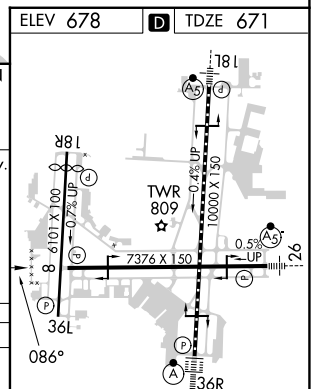
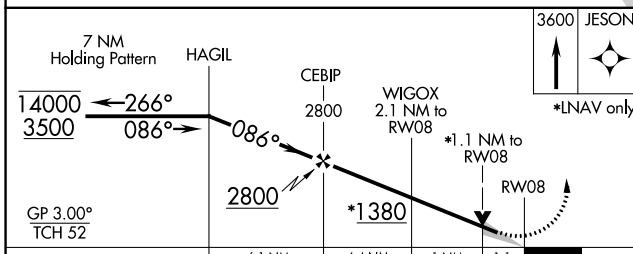
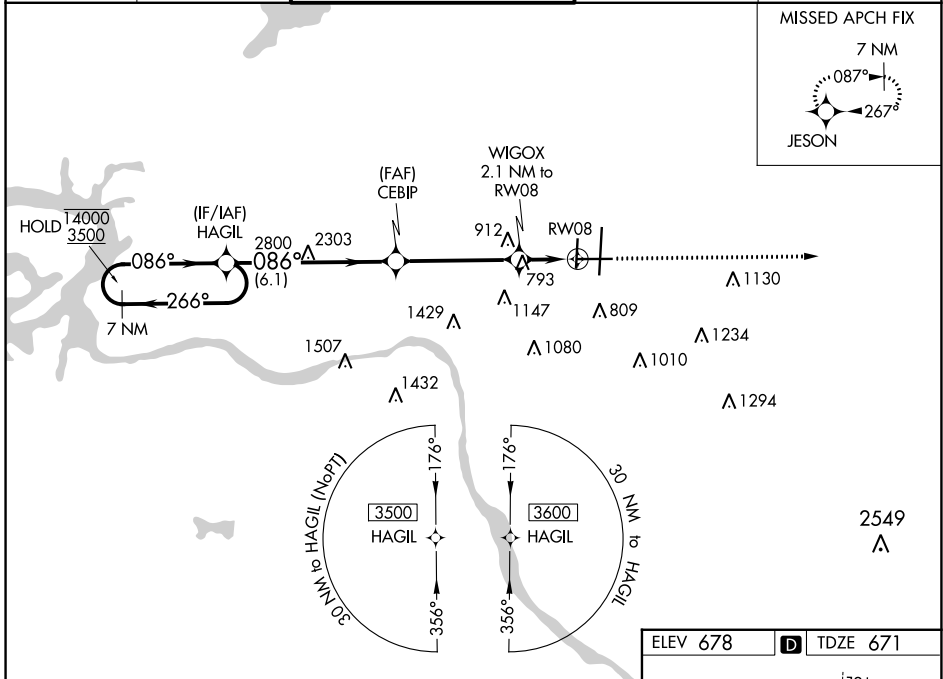

CATEGORY	A	B	C	D	E
LPV DA		921- ³ / ₄	250 (300- ³ / ₄)		
LNAV/VNAV DA		985-1	314 (400-1)		
LNAV MDA	1060-1	389 (400-1)	1060- ¹ / ₈	389 (400- ¹ / ₈)	
CIRCLING	1120-1 442 (500-1)	1160-1 482 (500-1)	1520-2 ¹ / ₂ 842 (900-2 ¹ / ₂)	1520-2 ³ / ₄ 842 (900-2 ³ / ₄)	1520-3 842 (900-3)

TDZ/CL Rwy 36R
HIRL Rwys 8-26, 18L-36R and 18R-36L
REIL Rwys 8, 18R and 36L

SC-1, 22 FEB 2024 to 21 MAR 2024

SC-1, 22 FEB 2024 to 21 MAR 2024

VORTAC TUL 114.4 Chan 91	APP CRS 082°	Rwy Idg TDZE Apt Elev	7376 671 678
---------------------------------------	------------------------	-----------------------------	---

VOR/DME RWY 8 TULSA INTL (TUL)

ASR Circling NA for Cat E south of Rwy 8-26. Helicopter visibility reduction below 3/4 SM NA. Autopilot coupled approach NA.

MISSED APPROACH: Climb to 3500 direct TUL VORTAC then via TUL R-079 to INOLA INT/TUL 17.8 DME and hold.

D-ATIS 124.9 377.2	TULSA APP CON 124.0 338.3	TULSA TOWER 121.2 310.8 (Rwys 18L-36R, 8-26) 118.7 257.8 (Rwy 18R-36L)	GND CON 121.9 348.6	CLNC DEL 134.05 284.7
------------------------------	-------------------------------------	--	-------------------------------	---------------------------------

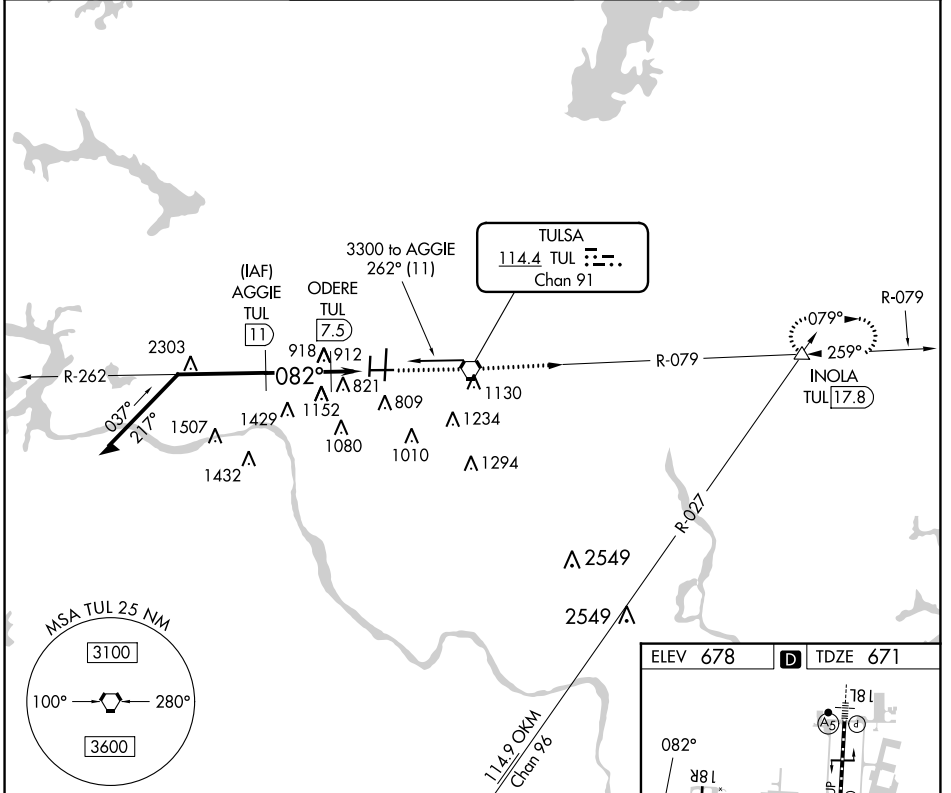

SC-1, 22 FEB 2024 to 21 MAR 2024

SC-1, 22 FEB 2024 to 21 MAR 2024

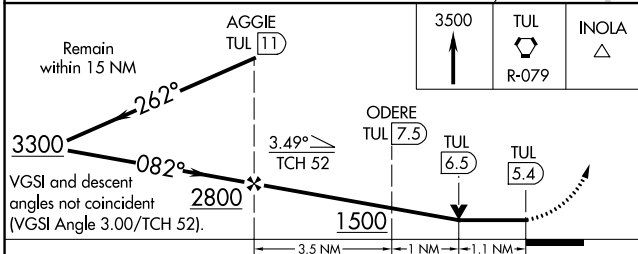

CATEGORY	A	B	C	D	E	
S-8	1080-1	409 (500-1)	1080-1 1/4	409 (500-1 1/4)	1080-1 1/2	409 (500-1 1/2)
CIRCLING	1120-1 442 (500-1)	1160-1 482 (500-1)	1520-2 1/2 842 (900-2 1/2)	1520-2 3/4 842 (900-2 3/4)	1520-3 842 (900-3)	

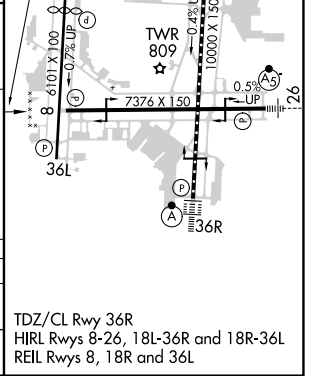

VORTAC TUL 114.4 Chan 91	APP CRS 262°	Rwy Idg TDZE Apt Elev 7376 652 678
---------------------------------------	------------------------	--

VOR or TACAN RWY 26

TULSA INTL (TUL)

⚠ Circling NA for Cat E south of Rwy 8-26. VOR Minimums: For inop ALS, increase Cat A/B visibility to 1 SM and Cat E to 1½ SM. DME Minimums: For inop ALS, increase Cat A/B visibility to 1 SM and Cat E to 1½ SM. **ASR**

MALSRL  MISSED APPROACH: Climbing left turn to 2600 via heading 220° and TUL R-238 to KEVIL INT/TUL 25.4 DME and hold.

D-ATIS 124.9 377.2	TULSA APP CON 124.0 338.3	TULSA TOWER 121.2 310.8 (Rwys 18L-36R, 8-26) 118.7 257.8 (Rwy 18R-36L)	GND CON 121.9 348.6	CLNC DEL 134.05 284.7
------------------------------	-------------------------------------	--	-------------------------------	---------------------------------

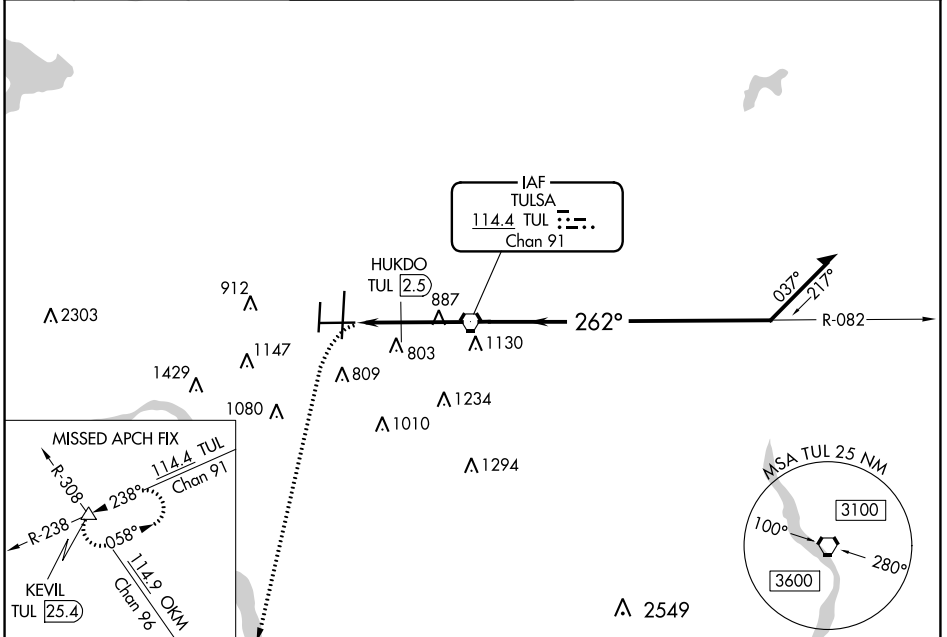

ELEV 678	D	TDZE 652
----------	----------	----------

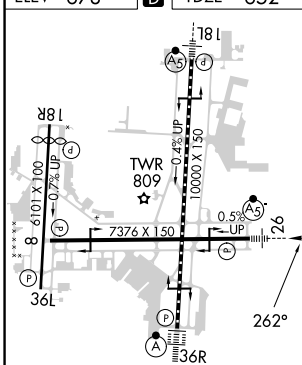

TDZ/CL Rwy 36R
HIRL Rwys 8-26, 18L-36R and 18R-36L
REIL Rwys 8, 18R and 36L

FAF to MAP 4.2 NM

Knots	60	90	120	150	180
Min:Sec	4:12	2:48	2:06	1:41	1:24

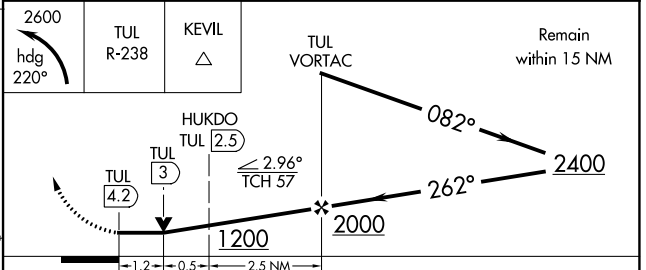

CATEGORY	A	B	C	D	E
S-26	1200-¾	548 (600-¾)	1200-1¼	548 (600-1¼)	
C CIRCLING	1200-1	522 (600-1)	1520-2½ 842 (900-2½)	1520-2¾ 842 (900-2¾)	1520-3 842 (900-3)
HUKDO FIX MINIMUMS					
S-26	1080-¾	428 (500-¾)	1080-¾	428 (500-¾)	1080-¾ 428 (500-¾)
C CIRCLING	1120-1 442 (500-1)	1160-1 482 (500-1)	1520-2½ 842 (900-2½)	1520-2¾ 842 (900-2¾)	1520-3 842 (900-3)

SC-1, 22 FEB 2024 to 21 MAR 2024

SC-1, 22 FEB 2024 to 21 MAR 2024

INSTRUMENT APPROACH PROCEDURE CHARTS

A IFR ALTERNATE AIRPORT MINIMUMS

Pilots must review the IFR Alternate Minimums Notes to determine alternate airport suitability.

ANA designation on the approach chart means that pilots may not use that approach as an alternate due to unmonitored facility, absence of weather reporting service, or lack of adequate navigation coverage. Approaches with the **A**NA designation are not listed in this section. **A** designation on the approach chart indicates that the approach procedure has non-standard minimums (for aircraft other than helicopters) or restrictions (for all users) for its use as an alternate.

Alternate Minima (ref: 14 CFR 91.169)

	Precision Approach	Non-Precision Approach
Standard	600-2	800-2
A Non-Standard or restrictions	As indicated below	As indicated below
Helicopters	For the selected approach: Ceiling: 200' above published ceiling Visibility: the greater of 1 SM visibility or the published visibility	
US Military (USA/USN/USAF)	See Service Regulations	

Note: For alternate airport flight planning purposes, precision approach operations include: ILS, PAR, and GLS, and Non-Precision approach operations include: NDB, VOR, LOC, TACAN, LDA, SDF, ASR, RNAV (GPS) and RNAV (RNP).

NAME ALTERNATE MINIMUMS

NAME ALTERNATE MINIMUMS

ADA, OK

ADA RGNL (ADH).....**RNAV (GPS) Rwy 18**
RNAV (GPS) Rwy 36

NA when local weather not available.
Category C, 900-2¼; Category D, 900-2½.

ARDMORE, OK (CON'T)

ARDMORE
MUNI (ADM).....**ILS or LOC Rwy 31¹²**
RNAV (GPS) Rwy 13³
RNAV (GPS) Rwy 31⁴
VOR-B⁵

NA when local weather not available.
¹NA when control tower closed.
²LOC, Category D, 1000-3.
³Category D, 800-2¼.
⁴Category D, 1000-3.
⁵Category C, 800-2¼ Category D, 1000-3.

ALTUS, OK

ALTUS/QUARTZ MOUNTAIN
RGNL (AXS).....**RNAV (GPS) Rwy 17**
RNAV (GPS) Rwy 35
VOR-A¹

NA when local weather not available.
¹NA when Altus tower closed.

BARTLESVILLE, OK

BARTLESVILLE
MUNI (BVO).....**RNAV (GPS) Rwy 17**
RNAV (GPS) Rwy 35
VOR/DME Rwy 35¹

NA when local weather not available.
¹Category D, 800-2¼.

ALVA, OK

ALVA RGNL (AVK).....**RNAV (GPS) Rwy 18**
RNAV (GPS) Rwy 36

NA when local weather not available.
Category C, 800-2¼.

ARDMORE, OK

ARDMORE DOWNTOWN
EXEC (1F0).....**RNAV (GPS) Rwy 17**
RNAV (GPS) Rwy 35

NA when local weather not available.
Category D, 800-2¼; Category D, 800-2½.

BATESVILLE, AR

BATESVILLE
RGNL (BVX).....**RNAV (GPS) Rwy 8**
RNAV (GPS) Rwy 26

NA when local weather not available.
Category C, 800-2¼; Category D, 1000-3.

22 FEB 2024 to 21 MAR 2024

22 FEB 2024 to 21 MAR 2024

NAME ALTERNATE MINIMUMS

BENTON, AR

SALINE COUNTY
RGNL (SUZ).....**ILS or LOC Rwy 2¹**
RNAV (GPS) Rwy 2²
RNAV (GPS) Rwy 20²

NA when local weather not available.
¹LOC, Category C, 900-2½; Category D, 900-2¾.
²Category C, 900-2½; Category D, 900-2¾.

BENTONVILLE, AR

BENTONVILLE MUNI/LOUISE M THADEN
FLD (VBT).....**RNAV (GPS) Rwy 18**
RNAV (GPS) Rwy 36

NA when local weather not available.

BLACKWELL, OK

BLACKWELL-TONKAWA
MUNI (BKN).....**RNAV (GPS) Rwy 17**
RNAV (GPS) Rwy 35
VOR-A

NA when local weather not available.

BLYTHEVILLE, AR

BLYTHEVILLE
MUNI (HKA).....**RNAV (GPS) Rwy 18**
RNAV (GPS) Rwy 36

NA when local weather not available.

BURNS FLAT, OK

CLINTON/
SHERMAN (CSM).....**ILS or LOC Rwy 17R¹**
RNAV (GPS) Rwy 17R²
RNAV (GPS) Rwy 35L²
VOR Rwy 35L²

NA when control tower closed.
¹ILS, Category D, 700-2¼; Category E, 700-2½;
LOC, Category D, 800-2¼;
Category E, 800-2½.
²Category D, 800-2¼; Category E, 800-2½.

CAMDEN, AR

HARRELL FLD (CDH).....**RNAV (GPS) Rwy 1**
RNAV (GPS) Rwy 19

NA when local weather not available.
Category D, 900-2¾.

CHANDLER, OK

CHANDLER
RGNL (CQB).....**RNAV (GPS) Rwy 17**
NA when local weather not available

CLINTON, OK

CLINTON
RGNL (CLK).....**RNAV (GPS) Rwy 17**
RNAV (GPS) Rwy 35

NA when local weather not available.

NAME ALTERNATE MINIMUMS

CORNING, AR

CORNING MUNI (4M9).....**RNAV (GPS) Rwy 18**
RNAV (GPS) Rwy 36

NA when local weather not available.

CUSHING, OK

CUSHING
MUNI (CUH).....**RNAV (GPS) Rwy 18**
RNAV (GPS) Rwy 36

NA when local weather not available.
Category D, 800-2¾.

DEQUEEN, AR

J. LYNN HELMS SEVIER
COUNTY (DEQ).....**RNAV (GPS) Rwy 8**
NA when local weather not available.

DURANT, OK

DURANT RGNL/
EAKER FLD (DUA).....**RNAV (GPS) Rwy 17**
RNAV (GPS) Rwy 35

NA when local weather not available.

ELK CITY, OK

ELK CITY
RGNL BUSINESS (ELK).....**RNAV (GPS) Rwy 17¹**
RNAV (GPS) Rwy 35

Category D, 1000-3.
¹NA when local weather not available.

EL RENO, OK

EL RENO
RGNL (RQO).....**RNAV (GPS) Rwy 17**
RNAV (GPS) Rwy 35

NA when local weather not available.
Category D, 800-2¾.

ENID, OK

ENID WOODRING
RGNL (WDG).....**ILS or LOC Rwy 35¹²³**
RNAV (GPS) Rwy 17¹⁴
RNAV (GPS) Rwy 35⁴
VOR Rwy 17¹⁵
VOR Rwy 35¹⁵

¹NA when local weather not available.
²NA when control tower closed.
³LOC, Category D, 800-2¼; Category E, 900-3
⁴Category D, 800-2¼; Category E, 900-3.
⁵Category D, 800-2¼.

FAYETTEVILLE, AR

DRAKE FLD (FYV).....**LDA Rwy 34¹²**
LOC Rwy 16¹³⁴
RNAV (GPS) Rwy 16³⁴
RNAV (GPS) Rwy 34³⁴

¹NA when control tower closed.
²Category C, 1100-3.
³NA when local weather not available.
⁴Categories C, D, 1100-3.

22 FEB 2024 to 21 MAR 2024

22 FEB 2024 to 21 MAR 2024

NAME ALTERNATE MINIMUMS

FAYETTEVILLE/SPRINGDALE/

ROGERS, AR

NORTHWEST ARKANSAS

NTL (XNA).....**ILS or LOC Rwy 16L¹²**
ILS or LOC Rwy 34R¹²
RNAV (GPS) Rwy 16L³
RNAV (GPS) Rwy 34R³

NA when local weather not available.

¹NA when control tower closed.

²LOC, Category C, 800-2¼; Category D, 800-2½;

Category E, 800-2¾.

³Category C, 800-2¼; Category D, 800-2½;

Category E, 800-2¾.

FLIPPIN, AR

MARION COUNTY

RGNL (FLP).....**RNAV (GPS) Rwy 4**
Category C, 800-2½.

FORT SMITH, AR

FORT SMITH

RGNL (FSM).....**ILS or LOC Rwy 8¹²**
ILS Z or LOC Z Rwy 26¹²
RADAR-1²³
RNAV (GPS) Rwy 2⁴
RNAV (GPS) Rwy 8³
RNAV (GPS) Rwy 26³
VOR Z or TACAN Z Rwy 8³
VOR Z or TACAN Z Rwy 26³

¹LOC, Category C, 1000-2¾;

Categories D, E, 1000-3.

²NA when control tower closed.

³Category C, 1000-2¾; Categories D, E, 1000-3.

⁴Category C, 1000-2¾; Category D, 1000-3.

FREDERICK, OK

FREDERICK

RGNL (FDR).....**RNAV (GPS) Rwy 35**
NA when local weather not available.

GUTHRIE, OK

GUTHRIE/EDMOND

RGNL (GOK).....**RNAV (GPS) Rwy 16**
RNAV (GPS) Rwy 34
NA when local weather not available.

GUYMON, OK

GUYMON MUNI (GUY).....**NDB Rwy 18¹**
RNAV (GPS) Rwy 18
RNAV (GPS) Rwy 36

NA when local weather not available.

Category C, 900-2½.

¹NA when APT manager's office closed.

HARRISON, AR

BOONE

COUNTY (HRO).....**RNAV (GPS) Rwy 18**
RNAV (GPS) Rwy 36
Category C, 1000-3; Category D, 1200-3.

NAME ALTERNATE

HOBART, OK

HOBART

RGNL (HBR).....**RNAV (GPS) Rwy 17**
RNAV (GPS) Rwy 35
VOR Rwy 35

NA when local weather not available.

Category C, 800-2¼; Category D, 900-3.

HOLLIS, OK

HOLLIS

MUNI (O35).....**RNAV (GPS) Rwy 18**
RNAV (GPS) Rwy 36

Category B, 900-2.

HOT SPRINGS, AR

MEML FLD (HOT).....**VOR Rwy 5**

NA when local weather not available.

Category C, 900-2½; Category D, 1100-3.

HUGO, OK

STAN STAMPER

MUNI (HHW).....**RNAV (GPS) Rwy 17¹**
RNAV (GPS) Rwy 35

Category C, 800-2¼; Category D, 800-2½.

¹NA when local weather not available.

JONESBORO, AR

JONESBORO

MUNI (JBR).....**ILS or LOC Rwy 23¹**
RNAV (GPS) Rwy 5²
RNAV (GPS) Rwy 23²
RNAV (GPS) Rwy 31²
VOR Rwy 23²

NA when local weather not available.

¹LOC, Category D, 900-2¼.

²Category D, 900-2¼.

LAWTON, OK

LAWTON-FORT SILL

RGNL (LAW).....**ILS or LOC Rwy 35¹²**
RNAV (GPS) Rwy 35³
VOR Rwy 35³

¹NA when control tower closed.

²LOC, Category D, 800-2¼.

³Category D, 800-2¼.

22 FEB 2024 to 21 MAR 2024

22 FEB 2024 to 21 MAR 2024

NAME ALTERNATE MINIMUMS

LITTLE ROCK, AR

BILL AND HILLARY CLINTON NTL/
 ADAMS FLD (LIT).....**ILS or LOC Rwy 4L**¹
 ILS or LOC Rwy 4R¹
 ILS or LOC Rwy 22L¹
 ILS or LOC Rwy 22R²³
 RNAV (GPS) Rwy 4L⁴
 RNAV (GPS) Rwy 4R⁴
 RNAV (GPS) Rwy 18⁴
 RNAV (GPS) Rwy 22L⁴
 RNAV (GPS) Rwy 22R⁴
 RNAV (GPS) Rwy 36⁴
 VOR-A⁴

¹LOC, Category C, 1000-2¾; Category D, 1000-3.
²NA when local weather not available.
³ILS, Category B, 800-2; Category C, 1000-2¾;
 Category D, 1000-3; LOC, Category C, 1000-2¾;
 Category D, 1000-3.
⁴Category C, 1000-2¾; Category D, 1000-3.

MC ALESTER, OK

MC ALESTER
 RGNL (MLC).....**RNAV (GPS) Rwy 2**
 RNAV (GPS) Rwy 20
 NA when local weather not available.

MENA, AR

MENA INTERMOUNTAIN
 MUNI (MEZ).....**ILS or LOC Rwy 27**¹
 RNAV (GPS) Rwy 17²
 NA when local weather not available.
¹LOC, Category B, 1100-2; Category C, 1200-3.
²Category B, 1100-2; Category C, 1200-3.

MIAMI, OK

MIAMI RGNL (MIO).....**RNAV (GPS) Rwy 17**
 NA when local weather not available.

MONTICELLO, AR

MONTICELLO MUNI/
 ELLIS FLD (LLQ).....**RNAV (GPS) Rwy 3**¹
 RNAV (GPS) Rwy 21²
 NA when local weather not available.
²Category D, 800-2¼.

MOUNTAIN HOME, AR

BAXTER
 COUNTY (BPK).....**RNAV (GPS) Rwy 5**
 RNAV (GPS) Rwy 23
 NA when local weather not available.

MUSKOGEE, OK

MUSKOGEE-DAVIS
 RGNL (MKO).....**RNAV (GPS) Rwy 4**¹
 RNAV (GPS) Rwy 13²
 RNAV (GPS) Rwy 22¹
 RNAV (GPS) Rwy 31²
 NA when local weather not available.

¹Category D, 800-2½.
²Category D, 800-2½; Category E, 1000-3.

NAME ALTERNATE MINIMUMS

NEWPORT, AR

NEWPORT
 RGNL (M19).....**RNAV (GPS) Rwy 18**
 RNAV (GPS) Rwy 36
 VOR Rwy 18¹

NA when local weather not available.
¹Categories A, B, 1100-2; Categories C, D, 1100-3.

NORMAN, OK

UNIVERSITY OF OKLAHOMA
 WESTHEIMER (OUN).....**ILS or LOC Rwy 18**¹²
 LOC Rwy 3¹³
 RNAV (GPS) Rwy 3³
 RNAV (GPS) Rwy 18³
 RNAV (GPS) Rwy 36³

NA when local weather not available.
¹NA when control tower closed.
²ILS, Categories A, B, 700-2; Category C,
 800-2¼; Category D, 800-2½; LOC, Category C,
 800-2¼; Category D, 800-2½.
³Category C, 800-2¼; Category D, 800-2½.

NORTH LITTLE ROCK, AR

NORTH LITTLE ROCK
 MUNI (ORK).....**LOC Rwy 5**
 RNAV (GPS) Rwy 5
 RNAV (GPS) Rwy 35
 NA when local weather not available.

OKLAHOMA CITY, OK

CLARENCE E.
 PAGE MUNI (RCE).....**RNAV (GPS) Rwy 17R**
 RNAV (GPS) Rwy 35L
 VOR-B

NA when local weather not available.

SUNDANCE (HSD).....**RNAV (GPS) Rwy 18**
 RNAV (GPS) Rwy 36
 VOR Rwy 18

NA when local weather not available.

WILEY POST (PWA).....**ILS or LOC Rwy 17L**¹
 ILS or LOC Rwy 35R¹
 RNAV (GPS) Rwy 17L
 RNAV (GPS) Rwy 17R
 RNAV (GPS) Rwy 35L
 RNAV (GPS) Rwy 35R
 VOR Rwy 17L
 VOR Rwy 35R

NA when local weather not available.
¹NA when control tower closed.

22 FEB 2024 to 21 MAR 2024

22 FEB 2024 to 21 MAR 2024

NAME ALTERNATE MINIMUMS

STIGLER, OK

STIGLER RGNL (GZL).....RNAV (GPS) Rwy 35
NA when local weather not available.

STILLWATER, OK

STILLWATER
RGNL (SWO).....ILS or LOC Rwy 17¹²
RNAV (GPS) Rwy 17³
RNAV (GPS) Rwy 35³
VOR Rwy 17³
VOR/DME Rwy 35³

NA when local weather not available.
¹NA when control tower closed.

²LOC, Category D, 800-2¼.
³Category D, 800-2¼.

STUTTGA RT, AR

STUTTGA RT MUNI CARL HUMPHREY
FIELD (SGT).....ILS or LOC Rwy 36
RNAV (GPS) Rwy 9
RNAV (GPS) Rwy 18
RNAV (GPS) Rwy 27
RNAV (GPS) Rwy 36

NA when local weather not available.

TAHLEQUAH, OK

TAHLEQUAH
MUNI (TQH).....RNAV (GPS) Rwy 17
RNAV (GPS) Rwy 35

NA when local weather not available.
Category C, 1000-2¼.

TEXARKANA, AR

TEXARKANA RGNL-WEBB
FLD (TXK).....ILS or LOC Rwy 22¹²
RNAV (GPS) Rwy 4³
RNAV (GPS) Rwy 13³
RNAV (GPS) Rwy 22³
RNAV (GPS) Rwy 31³
VOR Rwy 13³

NA when local weather not available.
¹NA when control tower closed.
²LOC, Category D, 800-2¼.
³Category D, 800-2¼

NAME ALTERNATE MINIMUMS

TULSA, OK

TULSA INTL (TUL).....ILS or LOC Rwy 18L²
ILS or LOC Rwy 18R¹
ILS or LOC Rwy 36R³
RADAR-1⁴
RNAV (GPS) Rwy 8⁴
RNAV (GPS) Rwy 18L⁴
RNAV (GPS) Rwy 18R⁴
RNAV (GPS) Rwy 36L⁵
RNAV (GPS) Rwy 36R⁴
VOR/DME Rwy 8¹
VOR or TACAN Rwy 26⁴

¹LOC, Category C, 900-2¼; Category D, 900-2¼.
²LOC, Category C, 900-2¼; Category D, 900-2¼; Category E, 900-3.
³LOC, Category C, 900-2¼; Category D, 900-2¼; Category E, 900-3.
⁴Category C, 900-2¼; Category D, 900-2¼; Category E, 900-3.
⁵Category C, 900-2¼; Category D, 900-2¼.

TULSA RIVERSIDE (RVS)....ILS or LOC Rwy 1L¹²
RNAV (GPS) Rwy 1L³
RNAV (GPS) Rwy 19R³
VOR/DME-A³

¹NA when control tower closed.
²LOC, Category D, 800-2¼.
³Category D, 800-2¼.

WALNUT RIDGE, AR

WALNUT RIDGE
RGNL (ARG).....RNAV (GPS) Rwy 4
RNAV (GPS) Rwy 18
RNAV (GPS) Rwy 22
RNAV (GPS) Rwy 36

NA when local weather not available.
Category D, 800-2¼.

WEATHERFORD, OK

WEATHERFORD
STAFFORD (OJA).....RNAV (GPS) Rwy 17
RNAV (GPS) Rwy 35

NA when local weather not available.
Category C, 800-2¼.

WEST MEMPHIS, AR

WEST MEMPHIS
MUNI (AWM).....RNAV (GPS) Rwy 17
RNAV (GPS) Rwy 35

NA when local weather not available.
Category D, 800-2¼.

WOODWARD, OK

WEST
WOODWARD (WWR).....RNAV (GPS) Rwy 17
RNAV (GPS) Rwy 35
VOR/DME-A

NA when local weather not available.
Category C, 800-2¼; Category D, 800-2¼.

22 FEB 2024 to 21 MAR 2024

22 FEB 2024 to 21 MAR 2024

RADAR MINS

23362

N1

RADAR INSTRUMENT APPROACH MINIMUMS

FORT SMITH, AR

Amdt 9, 15JUN23 (23166) (FAA)

ELEV 469

FORT SMITH RGNL (FSM)

RADAR-1 120.9 343.75 **T A**

	<u>RWY</u>	<u>GP/TCH/RPI</u>	<u>CAT</u>	<u>DA/ MDA-VIS</u>	<u>HAT/ HAA</u>	<u>CEIL-VIS</u>	<u>CAT</u>	<u>DA/ MDA-VIS</u>	<u>HAT/ HAA</u>	<u>CEIL-VIS</u>
ASR	26		AB	1020-24	572	(600-½)	CDE	1020-1¼	572	(600-1¼)
	8		AB	1200-½	731	(800-½)	CDE	1200-1⅝	731	(800-1⅝)
	2		A	1200-1	751	(800-1)	B	1200-1¼	751	(800-1¼)
			CDE	1200-2	751	(800-2)				
C CIRCLING ALL RWY			A	1200-1	731	(800-1)	B	1200-1½	731	(800-1½)
			C	1400-2¾	931	(1000-2¾)	DE	1400-3	931	(1000-3)

Circling CAT E NA when R-2401B active.

Circling NA for Cat E north of Rwy 8 and west of Rwy 20.

For inop ALS, increase ASR-08 CAT A and B visibility to 1 SM, CAT E visibility to 2 SM, and S-26 CAT E visibility to 1¼ SM.

Rwy 2 helicopter visibility reduction below ¾ SM NA.

Circling Rwy 20 NA at night.

HENRY POST AAF (FORT SILL) (KFSI), Fort Sill, OK Amdt 14 28DEC23

ELEV 1188

(23362) (USA)

RADAR - (E) 120.55 322.4 **T C**

	<u>RWY</u>	<u>GS/TCH/RPI</u>	<u>CAT</u>	<u>DH/ MDA-VIS</u>	<u>HAT/ HATh/ HAA</u>	<u>CEIL-VIS</u>
ASR	36 ¹		AB	1600/40	413	(500-¾)
			CDE	1600/50	413	(500-1)
	18		AB	1880-1	692	(700-1)
			CDE	1880-2	692	(700-2)
CIR ²	18-36		AB	1880-1	692	(700-1)
			C	1880-2	692	(700-2)
			D	1920-2¼	732	(800-2¼)
			E	1940-2¾	752	(800-2¾)

When local altimeter setting not received, use Lawton-Ft Sill Rgnl altimeter setting.

¹When ALS inop, increase CAT CDE RVR to 60.

²Circling NA for CAT E W of Rwy 18-36.

22 FEB 2024 to 21 MAR 2024

22 FEB 2024 to 21 MAR 2024

SC-1

RADAR INSTRUMENT APPROACH MINIMUMS

RADAR MINS

23362

N1

RADAR MINS

23362

N2

RADAR INSTRUMENT APPROACH MINIMUMS

LAWTON, OK

Amdt 4A, 10JAN00 (00010) (FAA)

ELEV 1110

LAWTON-FORT SILL RGNL (LAW)

RADAR-1 - 120.55 322.4

	<u>RWY</u>	<u>GP/TCH/RPI</u>	<u>CAT</u>	<u>DA/</u> <u>MDA-VIS</u>	<u>HAT/</u> <u>HAA</u>	<u>CEIL-VIS</u>	<u>CAT</u>	<u>DA/</u> <u>MDA-VIS</u>	<u>HAT/</u> <u>HAA</u>	<u>CEIL-VIS</u>
ASR	35		ABC	1560-¾	471	(500-¾)	D	1560-1	471	(500-1)
CIRCLING	ALL RWY		AB D	1600-1 1680-2	490 570	(500-1) (600-2)	C	1620-1½	510	(600-1½)

LAWTON, OK

Amdt 1B, 08AUG02 (02220) (FAA)

ELEV 1110

LAWTON-FORT SILL RGNL (LAW)

RADAR-2 - 120.55 322.4

	<u>RWY</u>	<u>GP/TCH/RPI</u>	<u>CAT</u>	<u>DA/</u> <u>MDA-VIS</u>	<u>HAT/</u> <u>HAA</u>	<u>CEIL-VIS</u>	<u>CAT</u>	<u>DA/</u> <u>MDA-VIS</u>	<u>HAT/</u> <u>HAA</u>	<u>CEIL-VS</u>
ASR	17		AB	1620-1	510	(600-1)	CD	1620-1½	510	(600-1½)
CIRCLING	ALL RWY		AB D	1620-1 1680-2	510 570	(600-1) (600-2)	C	1620-1½	510	(600-1½)

OKLAHOMA CITY, OK

Amdt 2A, 07APR11 (11153) (FAA)

ELEV 1299

WILEY POST (PWA)

RADAR-1 124.6 266.8 

	<u>RWY</u>	<u>GP/TCH/RPI</u>	<u>CAT</u>	<u>DA/</u> <u>MDA-VIS</u>	<u>HAT/</u> <u>HAA</u>	<u>CEIL-VIS</u>	<u>CAT</u>	<u>DA/</u> <u>MDA-VIS</u>	<u>HAT/</u> <u>HAA</u>	<u>CEIL-VIS</u>
ASR	35R		AB D	1840-1 1840-1¾	541 541	(600-1) (600-1¾)	C	1840-1½	541	(600-1½)
CIRCLING	ALL RWY		AB D	1840-1 1880-2	541 581	(600-1) (600-2)	C	1840-1½	541	(600-1½)

22 FEB 2024 to 21 MAR 2024

22 FEB 2024 to 21 MAR 2024

SC-1

RADAR INSTRUMENT APPROACH MINIMUMS

RADAR MINS

23362

N2

RADAR INSTRUMENT APPROACH MINIMUMS

**OKLAHOMA CITY, OK
WILL ROGERS WORLD (OKC)**

Amdt 21A, 13OCT16 (20030) (FAA)

ELEV 1296

RADAR-1 124.6 266.8 **▽ ▲**

	<u>RWY</u>	<u>GP/TCH/RPI</u>	<u>CAT</u>	<u>DA/ MDA-VIS</u>	<u>HAT/ HAA</u>	<u>CEIL-VIS</u>
ASR	17L		ABCDE	1680/40	393	(400-¾)
	35R		ABCDE	1680/40	386	(400-¾)
	17R		ABCDE	1680/40	398	(400-¾)
	35L		ABCDE	1680/40	404	(400-¾)
CIRCLING	ALL RWY		A	1740-1¼	444	(500-1¼)
			B	1760-1¼	464	(500-1¼)
			C	1960-1¼	664	(700-1¼)
			D	2000-2¼	704	(800-2¼)
			E	2240-3	944	(1000-3)

For inoperative MALSR, increase S-17L, S-17R, and S-35L CAT E visibility to 1¼.

For inoperative ALSF, increase S-35R CAT E visibility to 1¼.

22 FEB 2024 to 21 MAR 2024

22 FEB 2024 to 21 MAR 2024

RADAR INSTRUMENT APPROACH MINIMUMS

RADAR INSTRUMENT APPROACH MINIMUMS

TINKER AFB (KTIK), (Oklahoma City) OK (20086 USAF)

ELEV 1291

RADAR - Ctc OKLAHOMA CITY APP CON (E) 118.95 323.1 

	<u>RWY</u>	<u>GS/TCH/RPI</u>	<u>CAT</u>	<u>DH/ MDA-VIS</u>	<u>HAT/ HATH/ HAA</u>	<u>CEIL-VIS</u>
ASR	36 ¹		A	1940/24	649	(700-½)
			B	1940/40	649	(700-¾)
			C	1940/60	649	(700-1¼)
			D	1940-1½	649	(700-1½)
			E	1940-1¼	649	(700-1¾)
	18 ²		A	2000/40	733	(800-¾)
			B	2000/50	733	(800-1)
			C	2000-1¾	733	(800-1¾)
			D	2000-2	733	(800-2)
			E	2000-2¼	733	(800-2¼)
CIR ³	36		A	1940-1	649	(700-1)
			B	1940-1¼	649	(700-1¼)
			C	1940-1¾	649	(700-1¾)
			D	1980-2¼	689	(700-2¼)
			E	2040-2¾	749	(800-2¾)
	18		A	2000-1	709	(800-1)
			B	2000-1¼	709	(800-1¼)
			C	2000-2	709	(800-2)
			D	2000-2¼	709	(800-2¼)
			E	2040-2¾	749	(800-2¾)

¹When ALS inop, increase CAT A RVR to 50 and vis to 1 mile, CAT B RVR to 60 and vis to 1¼ miles, CAT C vis to 1¾ miles, CAT D vis to 2 miles, CAT E vis to 2¼ miles.

²When ALS inop, increase CAT A RVR to 50 and vis to 1 mile, CAT B RVR to 60 and vis to 1¼ miles, CAT C vis to 2 miles, CAT D vis to 2¼ miles, CAT E vis to 2½ miles.

³CAT E circling not authorized in sector S of Rwy 13-31 and W of Rwy 18-36.

22 FEB 2024 to 21 MAR 2024

22 FEB 2024 to 21 MAR 2024

RADAR INSTRUMENT APPROACH MINIMUMS

RADAR INSTRUMENT APPROACH MINIMUMS

TULSA, OK

Amdt 19, 19MAY22 (22139) (FAA)

ELEV 678

TULSA INTL (TUL)

RADAR-1 124.0 338.3 **▽ ▲**

	<u>RWY</u>	<u>GP/TCH/RPI</u>	<u>CAT</u>	<u>DA/ MDA-VIS</u>	<u>HAT/ HAA</u>	<u>CEIL-VIS</u>	<u>CAT</u>	<u>DA/ MDA-VIS</u>	<u>HAT/ HAA</u>	<u>CEIL-VIS</u>
ASR	18L		AB	1040/24	399	(400-½)	CDE	1040/35	399	(400-¾)
	18R		ABCD	1040-1	372	(400-1)	E	NA		
	26		ABCDE	1080-¾	428	(500-¾)				
	8		AB	1080-1	409	(500-1)	CDE	1080-1½	409	(500-1½)
	36R		AB	1120/24	470	(500-½)	CDE	1120/50	470	(500-1)
	36L		AB	1180-1	502	(600-1)	CD	1180-1½	502	(600-1¾)
			E	NA						

◻ CIRCLING ALL RWY	AB	1180-1	502	(600-1)	C	1500-2½	822	(900-2½)
	D	1520-2¾	842	(900-2¾)	E	1520-3	842	(900-3)

Circling NA for CAT E south of Rwy 8-26.

For inop ALS increase ASR S-18L CAT E visibility to RVR 6000.

For inop ALS increase ASR S-26 CAT A/B visibility to 1 SM, and CAT E visibility to 1¼ SM.

For inop ALS increase ASR S-36R CAT C/D/E visibility to 1¾ SM.

22 FEB 2024 to 21 MAR 2024

22 FEB 2024 to 21 MAR 2024

RADAR INSTRUMENT APPROACH MINIMUMS

TAKEOFF MINIMUMS, (OBSTACLE) DEPARTURE PROCEDURES, AND DIVERSE VECTOR AREA (RADAR VECTORS)

23278

INSTRUMENT APPROACH PROCEDURE CHARTS

IFR TAKEOFF MINIMUMS AND (OBSTACLE) DEPARTURE PROCEDURES

Civil Airports and Selected Military Airports

ALL USERS: Airports that have Departure Procedures (DPs) designed specifically to assist pilots in avoiding obstacles during the climb to the minimum enroute altitude, and/or airports that have civil IFR takeoff minimums other than standard, are listed below. Takeoff Minimums and Departure Procedures apply to all runways unless otherwise specified. An entry may also be listed that contains only Takeoff Obstacle Notes. Altitudes, unless otherwise indicated, are minimum altitudes in MSL.

DPs specifically designed for obstacle avoidance are referred to as Obstacle Departure Procedures (ODPs) and are textually described below, or published separately as a graphic procedure. If the ODP is published as a graphic procedure, its name will be listed below, and it can be found in either this volume (civil), or the applicable military volume, as appropriate. Users will recognize graphic obstacle DPs by the term "(OBSTACLE)" included in the procedure title; e.g., TETON TWO (OBSTACLE). If not specifically assigned an ODP, SID, or RADAR vector as part of an IFR clearance, an ODP may be required to be flown for obstacle clearance, even though not specifically stated in the IFR clearance. When doing so in this manner, ATC should be informed when the ODP being used contains a specified route to be flown, restrictions before turning, and/or altitude restrictions.

Some ODPs, which are established solely for obstacle avoidance, require a climb in visual conditions to cross the airport, a fix, or a NAVAID in a specified direction, at or above a specified altitude. These procedures are called Visual Climb Over Airport (VCOA). To ensure safe and efficient operations, the pilot must verbally request approval from ATC to fly the VCOA when requesting their IFR clearance.

At some locations where an ODP has been established, a diverse vector area (DVA) may be created to allow RADAR vectors to be used in lieu of an ODP. DVA information will state that headings will be as assigned by ATC and climb gradients, when applicable, will be published immediately following the specified departure procedure.

Graphic DPs designed by ATC to standardize traffic flows, ensure aircraft separation and enhance capacity are referred to as "Standard Instrument Departures (SIDs)". SIDs also provide obstacle clearance and are published under the appropriate airport section. ATC clearance must be received prior to flying a SID.

CIVIL USERS NOTE: Title 14 Code of Federal Regulations Part 91 prescribes standard takeoff rules and establishes takeoff minimums for certain operators as follows: (1) For aircraft, other than helicopters, having two engines or less – one statute mile visibility. (2) For aircraft having more than two engines – one-half statute mile visibility. (3) For helicopters – one-half statute mile visibility. These standard minima apply in the absence of any different minima listed below.

MILITARY USERS NOTE: Civil (nonstandard) takeoff minima are published below. For military takeoff minima, refer to appropriate service directives.

ADA, OK

ADA RGNL (ADH)

TAKEOFF MINIMUMS AND (OBSTACLE) DEPARTURE PROCEDURES

AMDT 4A 10SEP20 (20254) (FAA)

TAKEOFF MINIMUMS:

Rwy 13, 300-1¼ or std. w/min. climb of 270' per NM to 1300.

Rwy 18, 300-1½ or std. w/min. climb of 320' per NM to 1300.

DEPARTURE PROCEDURE:

Rwy 18, climb heading 177° to 1600 before proceeding on course.

TAKEOFF OBSTACLE NOTES:

Rwy 13, pole, post beginning 122' from DER, 72' right of centerline, up to 4' AGL/982' MSL.

Bush 315' from DER, 43' right of centerline, 988' MSL.

Tower 5476' from DER, 872' left of centerline, 120' AGL/1117' MSL.

Tower 5596' from DER, 1865' left of centerline, 180' AGL/1156' MSL.

Rwy 18, trees beginning 32' from DER, 99' right of centerline, up to 1021' MSL.

Tree 82' from DER, 272' left of centerline, 999' MSL.

Trees beginning 150' from DER, 393' left of centerline, up to 1024' MSL.

Trees beginning 196' from DER, 103' right of centerline, up to 1031' MSL.

Tree 367' from DER, 368' left of centerline, 1028' MSL.

Trees beginning 524' from DER, 373' left of centerline, up to 1040' MSL.

Tree 973' from DER, 675' left of centerline, 1041' MSL.

Ant on pole, tank, tower beginning 1017' from DER, 449' left of centerline, up to 1053' MSL.

Trees beginning 1530' from DER, 308' right of centerline, up to 1037' MSL.

Tower 2672' from DER, 675' right of centerline, 106' AGL/1092' MSL.

Tower, pole beginning 1 NM from DER, 1280' right of centerline, up to 165' AGL/1165' MSL.

Rwy 31, pole, wsk beginning 15' from DER, 264' left of centerline, up to 25' AGL/1022' MSL.

Pole, ol on amom beginning 1088' from DER, 548' right of centerline, up to 36' AGL/1042' MSL.

Trees beginning 2565' from DER, 988' right of centerline, up to 1083' MSL.

Rwy 36, tower, ant beginning 55' from DER, 423' left of centerline, up to 11' AGL/1026' MSL.

Trees beginning 75' from DER, 71' left of centerline, up to 1061' MSL.

Tree 132' from DER, 278' right of centerline, 1020' MSL.

Trees beginning 329' from DER, 267' left of centerline, up to 1065' MSL.

Tree 345' from DER, 267' right of centerline, 1028' MSL.

Tree 551' from DER, 261' right of centerline, 1030' MSL.

Tree 927' from DER, 281' right of centerline, 1040' MSL.

Tree 1011' from DER, 675' right of centerline, 1050' MSL.

TAKEOFF MINIMUMS, (OBSTACLE) DEPARTURE PROCEDURES, AND DIVERSE VECTOR AREA (RADAR VECTORS)

23278

SC-1

ALMYRA, AR

ALMYRA MUNI (M73)

TAKEOFF MINIMUMS AND (OBSTACLE) DEPARTURE PROCEDURES

ORIG 20OCT11 (11293) (FAA)

TAKEOFF OBSTACLE NOTES:

Rwy 10, trees beginning 735' from DER, 561' left of centerline, up to 50' AGL/248' MSL.

Trees beginning 645' from DER, 208' right of centerline, up to 50' AGL/255' MSL.

Rwy 18, trees beginning 1234' from DER, 294' right of centerline, up to 50' AGL/255' MSL.**Rwy 28**, vehicle on road 142' from DER, 527' right of centerline, 15' AGL/220' MSL.**Rwy 36**, vehicle on road 453' from DER, 41' left of centerline, 15' AGL/220' MSL.

Tree 144' from DER, 487' right of centerline, 50' AGL/259' MSL.

ALTUS, OK

ALTUS/QUARTZ MOUNTAIN RGNL (AXS)

TAKEOFF MINIMUMS AND (OBSTACLE) DEPARTURE PROCEDURES

ORIG 24SEP09 (09267) (FAA)

TAKEOFF OBSTACLE NOTES:

Rwy 35, terrain 51' from DER, 410' right of centerline, 1435' MSL.

Trees beginning 1215' from DER, 765' left of centerline, up to 40' AGL/1470' MSL.

ALTUS AFB (KLTS)

ALTUS, OK

TAKEOFF MINIMUMS AND (OBSTACLE) DEPARTURE PROCEDURES

AMDT 4 14JUL22 (22195) (USAF)

TAKEOFF OBSTACLE NOTES:

176' assault strip, aircraft taxiing between 951' and 2314' from DER, 716' left of centerline, 65' AGL/1424' MSL.

ALVA, OK

ALVA RGNL (AVK)

TAKEOFF MINIMUMS AND (OBSTACLE) DEPARTURE PROCEDURES

AMDT 3 24MAR22 (22083) (FAA)

TAKEOFF MINIMUMS:

Rwys 9, 27, NA-Environmental.

TAKEOFF OBSTACLE NOTES:

Rwy 18, sign 24' from DER, 252' left of centerline, 3' AGL/1471' MSL.**Rwy 36**, bldg 2523' from DER, 327' left of centerline, 74' AGL/1549' MSL.**ANTLERS, OK**

ANTLERS MUNI (80F)

TAKEOFF MINIMUMS AND (OBSTACLE) DEPARTURE PROCEDURES

AMDT 1 30JAN20 (20030) (FAA)

TAKEOFF OBSTACLE NOTES:

Rwy 17, vehicles on road, terrain beginning 6' from DER, 143' left of centerline, up to 579' MSL.

Tree 16' from DER, 498' left of centerline, 49' AGL/610' MSL.

Tree 48' from DER, 352' right of centerline, 62' AGL/612' MSL.

Trees, electrical system beginning 53' from DER, 318' right of centerline, up to 615' MSL.

Tree 67' from DER, 473' left of centerline, 618' MSL.

Trees, vehicles on road beginning 96' from DER, 286' left of centerline, up to 67' AGL/624' MSL.

Trees beginning 325' from DER, 201' right of centerline, up to 88' AGL/623' MSL.

Rwy 35, vehicles on road, terrain beginning 4' from DER, 197' right of centerline, up to 586' MSL.

Trees, vehicles on road beginning 49' from DER, 262' left of centerline, up to 22' AGL/589' MSL.

Trees beginning 70' from DER, 324' right of centerline, up to 51' AGL/627' MSL.

Trees beginning 147' from DER, 318' right of centerline, up to 52' AGL/630' MSL.

Tree, building beginning 223' from DER, 401' left of centerline, up to 25' AGL/591' MSL.

Electrical system 321' from DER, 372' left of centerline, 31' AGL/595' MSL.

Trees beginning 362' from DER, 419' right of centerline, up to 60' AGL/639' MSL.

Tree 390' from DER, 327' left of centerline, 36' AGL/596' MSL.

Trees, vehicles on road, electrical system beginning 401' from DER, 35' right of centerline, up to 65' AGL/640' MSL.

Trees, pole, electrical system beginning 405' from DER, 315' left of centerline, up to 45' AGL/606' MSL.

Tree 495' from DER, 224' left of centerline, 63' AGL/618' MSL.

Trees beginning 495' from DER, 259' left of centerline, up to 623' MSL.

Trees beginning 563' from DER, 25' left of centerline, up to 89' AGL/642' MSL.

Trees beginning 1168' from DER, 8' right of centerline, up to 69' AGL/642' MSL.

Trees beginning 2057' from DER, 122' right of centerline, up to 73' AGL/646' MSL.

Tree 2466' from DER, 246' right of centerline, 74' AGL/650' MSL.

22 FEB 2024 to 21 MAR 2024

22 FEB 2024 to 21 MAR 2024



TAKEOFF MINIMUMS, (OBSTACLE) DEPARTURE PROCEDURES, AND DIVERSE VECTOR AREA (RADAR VECTORS)

23278

ARDMORE, OK

ARDMORE DOWNTOWN EXEC (1F0)

TAKEOFF MINIMUMS AND (OBSTACLE) DEPARTURE PROCEDURES

AMDT 3 10MAR11 (21336) (FAA)

TAKEOFF MINIMUMS:

Rwy 35, 300-1¼ or std. w/min. climb of 344' per NM to 1200.

TAKEOFF OBSTACLE NOTES:

Rwy 17, ground abeam DER, 110' right of centerline, up to 858' MSL.

Vehicles 535' from DER, 288' right of centerline, up to 15' AGL/863' MSL.

Pole 467' from DER, 366' right of centerline, 29' AGL/886' MSL.

Trees beginning 239' from DER, 180' right of centerline, up to 40' AGL/880' MSL.

Trees beginning 25' from DER, 449' left of centerline, up to 40' AGL/880' MSL.

Vehicles 658' from DER, 311' left of centerline, up to 15' AGL/862' MSL.

Rwy 35, trees beginning 256' from DER, 358' right of centerline, up to 52' AGL/938' MSL.

Pole 671' from DER, 261' right of centerline, 28' AGL/862' MSL.

Trees beginning 82' from DER, 318' left of centerline, up to 78' AGL/942' MSL.

Pole 332' from DER, 198' left of centerline, 11' AGL/855' MSL.

Antenna 496' from DER, 243' left of centerline, 44' AGL/894' MSL.

Hopper 5781' from DER, 1444' left of centerline, 214' AGL/1091' MSL.

ARDMORE MUNI (ADM)

TAKEOFF MINIMUMS AND (OBSTACLE) DEPARTURE PROCEDURES

AMDT 2 20OCT11 (11293) (FAA)

TAKEOFF MINIMUMS:

Rwy 13, 300-1 or std. w/min. climb of 330' per NM to 1000.

Rwy 31, std. w/min. climb of 330' per NM to 1200.

Rwy 35, 400-2½ or std. w/min. climb of 250' per NM to 1300.

DEPARTURE PROCEDURE:

Rwy 35, climb heading 354° to 1400 before proceeding on course.

TAKEOFF OBSTACLE NOTES:

Rwy 13, vehicles on road beginning 570' from DER, 626' right of centerline, up to 15' AGL/744' MSL.

Trees beginning 764' from DER, 611' right of centerline, up to 75' AGL/786' MSL.

Trees beginning 810' from DER, 566' left of centerline, up to 66' AGL/776' MSL.

Trees beginning 3342' from DER, 876' left of centerline, up to 100' AGL/899' MSL.

Rwy 17, tree 536' from DER, 359' right of centerline, 28' AGL/748' MSL.

Trees beginning 1701' from DER, left and right of centerline, up to 100' AGL/819' MSL.

Rwy 31, tree 292' from DER, 192' right of centerline, 72' AGL/862' MSL.

Vehicles on road beginning 1281' from DER, left and right of centerline, up to 15' AGL/842' MSL.

Trees beginning 1662' from DER, left and right of centerline, up to 67' AGL/890' MSL.

Trees beginning 1.07 NM from DER, 612' right of centerline, up to 42' AGL/1028' MSL.

Rising terrain beginning 3.22 NM from DER, left and right of centerline, up to 1199' MSL.

Rwy 35, tree 336' from DER, 523' right of centerline, 32' AGL/782' MSL.

Trees beginning 1554' from DER, left and right of centerline, up to 70' AGL/838' MSL.

Trees beginning 1.72 NM from DER, 242' right of centerline, up to 38' AGL/1118' MSL.

ARKADELPHIA, AR

DEXTER B FLORENCE MEML FLD (ADF)

TAKEOFF MINIMUMS AND (OBSTACLE) DEPARTURE PROCEDURES

AMDT 3 13NOV14 (22139) (FAA)

TAKEOFF MINIMUMS:

Rwy 4, 300-1¼ or std. w/min. climb of 237' per NM to 400, or alternatively, with std. takeoff minimums and a normal 200' per NM climb gradient, takeoff must occur no later than 1900' prior to DER.

TAKEOFF OBSTACLE NOTES:

Rwy 4, trees abeam DER, 471' left of centerline, up to 42' AGL/241' MSL.

Buildings, fences, and vehicles in parking lots 8' from DER, 273' left of centerline, up to 19' AGL/201' MSL.

Trees beginning 14' from DER, 257' right of centerline, up to 68' AGL/269' MSL.

Sign and lights beginning 23' from DER, left and right of centerline, up to 3' AGL/183' MSL.

Trees 1001' from DER, 10' left of centerline, up to 69' AGL/268' MSL.

Trees beginning 1032' from DER, 3' right of centerline, up to 64' AGL/263' MSL.

Trees 2018' from DER, 8' left of centerline, up to 68' AGL/267' MSL.

Trees beginning 2018' from DER, 93' right of centerline, up to 74' AGL/293' MSL.

Building 5532' from DER, 1298' left of centerline, 104' AGL/346' MSL.

Rwy 22, lights beginning 38' from DER, 110' right of centerline, up to 2' AGL/182' MSL.

Railroad beginning 401' from DER, 578' right of centerline, up to 23' AGL/210' MSL.

Trees beginning 1810' from DER, 368' right of centerline, up to 74' AGL/275' MSL.

TAKEOFF MINIMUMS, (OBSTACLE) DEPARTURE PROCEDURES, AND DIVERSE VECTOR AREA (RADAR VECTORS)

23278

SC-1

TAKEOFF MINIMUMS, (OBSTACLE) DEPARTURE PROCEDURES, AND DIVERSE VECTOR AREA (RADAR VECTORS)

23278

ASH FLAT, AR

SHARP COUNTY RGNL (CVK)

TAKEOFF MINIMUMS AND (OBSTACLE) DEPARTURE PROCEDURES

ORIG 05JUL07 (07186) (FAA)

TAKEOFF OBSTACLE NOTES:

Rwy 4, numerous trees beginning 1151' from DER, 576' right of centerline, up to 100' AGL/839' MSL.

Rwy 22, numerous trees beginning 548' from DER, 83' left of centerline, up to 100' AGL/759' MSL.

AUGUSTA, AR

WOODRUFF COUNTY (M60)

TAKEOFF MINIMUMS AND (OBSTACLE) DEPARTURE PROCEDURES

ORIG 07DEC17 (17341) (FAA)

TAKEOFF OBSTACLE NOTES:

Rwy 9, trees beginning 714' from DER, 686' right of centerline, up to 324' MSL/125' AGL.

Trees beginning 915' from DER, 230' right of centerline, up to 324' MSL/125' AGL.

Trees beginning 1094' from DER, 348' left of centerline, up to 324' MSL/125' AGL.

Rwy 27, vehicle on road 285' from DER, crossing centerline, 214' MSL/15' AGL.

BARTLESVILLE, OK

BARTLESVILLE MUNI (BVO)

TAKEOFF MINIMUMS AND (OBSTACLE) DEPARTURE PROCEDURES

ORIG-A 30JAN20 (20030) (FAA)

TAKEOFF MINIMUMS:

Rwy 17, 200-1 or std. w/min. climb of 257' per NM to 1000, or alternatively, with std. takeoff minimums and normal 200' per NM climb gradient, takeoff must occur no later than 2200' prior to DER.

Rwy 35, 400-2¼ or std. w/min. climb of 300' per NM to 1200.

TAKEOFF OBSTACLE NOTES:

Rwy 17, fence beginning 122' from DER, 464' right of centerline, up to 9' AGL/723' MSL.

Vehicles on road 209' from DER, 500' right of centerline, 731' MSL.

Tree 217' from DER, 542' right of centerline, 24' AGL/740' MSL.

Tree, fence, vehicles on road, pole beginning 250' from DER, 168' right of centerline, up to 34' AGL/749' MSL.

Tree 1202' from DER, 813' right of centerline, 47' AGL/753' MSL.

Tree 1254' from DER, 496' right of centerline, 55' AGL/761' MSL.

Trees beginning 1410' from DER, 749' right of centerline, up to 67' AGL/769' MSL.

Trees beginning 1664' from DER, 440' right of centerline, up to 70' AGL/771' MSL.

Trees beginning 1706' from DER, 42' left of centerline, up to 68' AGL/770' MSL.

Tree 1865' from DER, 409' left of centerline, 81' AGL/780' MSL.

Rwy 35, fence 2' from DER, 385' left of centerline, 10' AGL/686' MSL.

NAVAID, fence, wall beginning 10' from DER, 4' left of centerline, up to 3' AGL/687' MSL.

NAVAID beginning 10' from DER, 5' right of centerline, up to 2' AGL/686' MSL.

Trees beginning 45' from DER, 458' left of centerline, up to 43' AGL/704' MSL.

Trees beginning 140' from DER, 507' left of centerline, up to 82' AGL/745' MSL.

Trees beginning 1357' from DER, 281' left of centerline, up to 71' AGL/758' MSL.

Tree 2927' from DER, 1041' right of centerline, 59' AGL/767' MSL.

Tree 3410' from DER, 951' right of centerline, 81' AGL/794' MSL.

Trees beginning 1.1 NM from DER, 212' right of centerline, up to 20' AGL/881' MSL.

Tree, pole beginning 1.1 NM from DER, 182' right of centerline, up to 34' AGL/894' MSL.

Trees beginning 1.1 NM from DER, 148' right of centerline, up to 37' AGL/900' MSL.

Tree, pole beginning 1.1 NM from DER, 175' right of centerline, up to 45' AGL/903' MSL.

Trees beginning 1.3 NM from DER, 2313' right of centerline, up to 40' AGL/904' MSL.

Vehicles on road, trees beginning 1.3 NM from DER, 2587' right of centerline, up to 905' MSL.

Vehicles on road, trees beginning 1.3 NM from DER, 2336' right of centerline, up to 910' MSL.

Terrain, trees beginning 1.4 NM from DER, 2399' right of centerline, up to 931' MSL.

Tree 1.4 NM from DER, 2593' right of centerline, 21' AGL/936' MSL.

Tree, vehicles on road beginning 1.4 NM from DER, 1426' right of centerline, up to 33' AGL/974' MSL.

Tree 1.8 NM from DER, 1678' right of centerline, 28' AGL/973' MSL.

BATESVILLE, AR

BATESVILLE RGNL (BVX)

TAKEOFF MINIMUMS AND (OBSTACLE) DEPARTURE PROCEDURES

AMDT 3B 21MAY20 (20142) (FAA)

TAKEOFF MINIMUMS:

Rwy 8, 300-1¼ or std. w/min. climb of 215' per NM to 800, or alternatively, with std. takeoff minimums and a normal 200' per NM climb gradient, takeoff must occur no later than 1600' prior to DER.

Rwy 26, std. w/min. climb of 272' per NM to 2000, or 1100-2½ for VCOA.

DEPARTURE PROCEDURE:

Rwy 18, climb on heading 180° to 1300 before turning right.

VCOA:

Rwy 26, obtain ATC approval for VCOA when requesting IFR clearance. Climb in visual conditions to cross Batesville RGNL Airport at or above 1400 before proceeding on course.

CON'T

TAKEOFF MINIMUMS, (OBSTACLE) DEPARTURE PROCEDURES, AND DIVERSE VECTOR AREA (RADAR VECTORS)

23278

SC-1

22 FEB 2024 to 21 MAR 2024

22 FEB 2024 to 21 MAR 2024

BATESVILLE, AR (CON'T)
BATESVILLE RGNL (BVX) (CON'T)

TAKEOFF OBSTACLE NOTES:

Rwy 8, pole 204' from DER, 515' left of centerline, 24' AGL/483' MSL.
 Tower 1023' from DER, 657' right of centerline, 54' AGL/524' MSL.
 Pole 1091' from DER, 393' left of centerline, 34' AGL/495' MSL.
 Pole 1136' from DER, 434' left of centerline, 37' AGL/497' MSL.
 Trees beginning 1233' from DER, 632' right of centerline, up to 526' MSL.
 Trees beginning 1359' from DER, 22' right of centerline, up to 527' MSL.
 Trees beginning 1412' from DER, 465' left of centerline, up to 513' MSL.
 Trees beginning 1554' from DER, 575' right of centerline, up to 542' MSL.
 Trees beginning 1886' from DER, 89' right of centerline, up to 547' MSL.
 Trees beginning 2187' from DER, 284' right of centerline, up to 548' MSL.
 Trees beginning 2346' from DER, 155' left of centerline, up to 539' MSL.
 Trees beginning 2639' from DER, 172' left of centerline, up to 541' MSL.
 Trees beginning 2973' from DER, 25' left of centerline, up to 567' MSL.
 Tree 3191' from DER, 181' right of centerline, 554' MSL.
 Tree 3844' from DER, 448' right of centerline, 565' MSL.
 Tree 3963' from DER, 688' right of centerline, 575' MSL.
 Terrain+veg 5544' from DER, 1978' right of centerline, 100' AGL/606' MSL.
 Trees 1.3 NM from DER, 900' right of centerline, up to 100' AGL/679' MSL.
Rwy 18, vehicle on road beginning 544' from DER, on centerline, 15' AGL/476' MSL.
 Hangars beginning 605' from DER, 12' right of centerline, up to 21' AGL/484' MSL.
 Tree 1244' from DER, 175' left of centerline, 48' AGL/521' MSL.
 Tree 1439' from DER, 409' right of centerline, 45' AGL/524' MSL.
Rwy 26, trees beginning 494' from DER, 335' left of centerline, up to 33' AGL/472' MSL.
Rwy 36, trees beginning 256' from DER, 107' left of centerline, up to 100' AGL/539' MSL.

BENTON, AR**SALINE COUNTY RGNL (SUZ)**

TAKEOFF MINIMUMS AND (OBSTACLE) DEPARTURE PROCEDURES

AMDT 1 23JUN16 (16175) (FAA)

DEPARTURE PROCEDURE:

Rwy 2, climb on heading 019° to 900 before proceeding on course.

TAKEOFF OBSTACLE NOTES:

Rwy 2, ground 69' from DER, 450' right of centerline, 394' MSL.
 Tree 319' from DER, 441' right of centerline, 399' MSL.
 Tree 443' from DER, 437' right of centerline, 401' MSL.
 Tree 566' from DER, 485' right of centerline, 406' MSL.
 Tree 948' from DER, 375' right of centerline, 430' MSL.
 Trees beginning 1035' from DER, 246' right of centerline, up to 435' MSL.
 Trees beginning 1180' from DER, 408' right of centerline, up to 444' MSL.
 Trees beginning 1274' from DER, 284' right of centerline, up to 450' MSL.
 Trees beginning 1472' from DER, 417' right of centerline, up to 454' MSL.
 Terrain 185' from DER, 336' left of centerline, 394' MSL.
 Tree, terrain beginning 199' from DER, 330' left of centerline, up to 439' MSL.
 Tree 420' from DER, 354' left of centerline, 440' MSL.
 Trees beginning 445' from DER, 395' left of centerline, up to 460' MSL.
 Tree 640' from DER, 641' left of centerline, 463' MSL.
 Trees beginning 726' from DER, 444' left of centerline, up to 469' MSL.
 Trees beginning 930' from DER, 474' left of centerline, up to 472' MSL.
 Trees beginning 995' from DER, 732' left of centerline, up to 474' MSL.
Rwy 20, tree 1314' from DER, 145' right of centerline, 431' MSL.
 Tree 1383' from DER, 279' right of centerline, 432' MSL.
 Pole 1397' from DER, 9' right of centerline, 71' AGL/436' MSL.
 Tree 1467' from DER, 293' right of centerline, 438' MSL.
 Tree 1561' from DER, 96' right of centerline, 439' MSL.
 Tree 1563' from DER, 245' right of centerline, 443' MSL.
 Tree 1795' from DER, 71' right of centerline, 445' MSL.
 Tree 1220' from DER, 45' left of centerline, 428' MSL.
 Trees beginning 1297' from DER, 15' left of centerline, up to 430' MSL.
 Tree 1556' from DER, 33' left of centerline, 431' MSL.

22 FEB 2024 to 21 MAR 2024

22 FEB 2024 to 21 MAR 2024

BENTONVILLE, AR

BENTONVILLE MUNI/LOUISE M THADEN FLD (VBT)

TAKEOFF MINIMUMS AND (OBSTACLE) DEPARTURE PROCEDURES

AMDT 2A 03NOV22 (22307) (FAA)

TAKEOFF MINIMUMS:

Rwys 17, 35, NA-Environmental.**Rwy 36**, 300-2¼ or std. w/min. climb of 204' per NM to 1700.

TAKEOFF OBSTACLE NOTES:

Rwy 18, building 109' from DER, 458' left of centerline, 11' AGL/1298' MSL.

Building 222' from DER, 550' left of centerline, 19' AGL/1305' MSL.

Pole 595' from DER, 302' left of centerline, 31' AGL/1320' MSL.

Poles beginning 599' from DER, 404' left of centerline, up to 33' AGL/1321' MSL.

Buildings, pole beginning 797' from DER, 209' right of centerline, up to 34' AGL/1325' MSL.

Building 1001' from DER, 617' left of centerline, 36' AGL/1331' MSL.

Pole 1224' from DER, 391' left of centerline, 42' AGL/1341' MSL.

Pole 1224' from DER, 214' right of centerline, 38' AGL/1330' MSL.

Pole 1238' from DER, 237' right of centerline, 41' AGL/1332' MSL.

Pole 1240' from DER, 823' right of centerline, 38' AGL/1335' MSL.

Poles beginning 1342' from DER, 158' right of centerline, up to 38' AGL/1336' MSL.

Pole 1370' from DER, 830' right of centerline, 40' AGL/1337' MSL.

Poles beginning 1588' from DER, 160' right of centerline, up to 49' AGL/1341' MSL.

Rwy 36, tree 162' from DER, 515' left of centerline, 1347' MSL.

Tree, traverse way beginning 178' from DER, 229' left of centerline, up to 1348' MSL.

Trees, traverse way beginning 290' from DER, 184' right of centerline, up to 1319' MSL.

Trees, traverse way, transmission line, pole beginning 330' from DER, 5' left of centerline, up to 1353' MSL.

Tree 1799' from DER, 882' right of centerline, 1341' MSL.

Tree, transmission line beginning 1991' from DER, 19' right of centerline, up to 1354' MSL.

Transmission line 2049' from DER, 755' right of centerline, 81' AGL/1356' MSL.

Pole 2050' from DER, 772' right of centerline, 85' AGL/1360' MSL.

Pole 2181' from DER, 753' left of centerline, 106' AGL/1379' MSL.

Tower 4063' from DER, 969' left of centerline, 144' AGL/1421' MSL.

Buildings beginning 4240' from DER, 936' right of centerline, up to 133' AGL/1420' MSL.

Tower 1.9 NM from DER, 1599' left of centerline, 333' AGL/1587' MSL.

BERRYVILLE, AR

CARROLL COUNTY (4M1)

TAKEOFF MINIMUMS AND (OBSTACLE) DEPARTURE PROCEDURES

ORIG 13JAN11 (11013) (FAA)

TAKEOFF MINIMUMS:

Rwy 7, std. w/ min. climb of 355' per NM to 2700, or 1100-2½ for climb in visual conditions.**Rwy 25**, std. w/ min. climb of 365' per NM to 2500, or 1100-2½ for climb in visual conditions.

DEPARTURE PROCEDURE:

Rwys 7, 25, For climb in visual conditions: cross Carroll County airport at or above 2200 before proceeding on course.

TAKEOFF OBSTACLE NOTES:

Rwy 7, terrain and trees beginning 8' from DER, 118' right of centerline, up to 100' AGL/1379' MSL.

Hangars beginning 141' from DER, 238' left of centerline, up to 17' AGL/1218' MSL.

Terrain and trees beginning 268' from DER, 77' left of centerline, up to 100' AGL/1379' MSL.

Rwy 25, trees beginning 93' from DER, 212' right of centerline, up to 100' AGL/1419' MSL.

Tree 104' from DER, 186' left of centerline, 51' AGL/1204' MSL.

BLACKWELL, OK

BLACKWELL-TONKAWA MUNI (BKN)

TAKEOFF MINIMUMS AND (OBSTACLE) DEPARTURE PROCEDURES

ORIG 23SEP10 (10266) (FAA)

TAKEOFF OBSTACLE NOTES:

Rwy 35, trees beginning 50' from DER, 249' left of centerline, up to 30' AGL/1050' MSL.

Road with vehicles beginning 214' from DER, 397' right of centerline, up to 15' AGL/1043' MSL.

BLYTHEVILLE, AR

ARKANSAS INTL (BYH)

TAKEOFF MINIMUMS AND (OBSTACLE) DEPARTURE PROCEDURES

AMDT 1 11DEC14 (14345) (FAA)

TAKEOFF OBSTACLE NOTES:

Rwy 36, tree 3301' from DER, 1187' left of centerline, 88' AGL/337' MSL.

TAKEOFF MINIMUMS, (OBSTACLE) DEPARTURE PROCEDURES, AND

DIVERSE VECTOR AREA (RADAR VECTORS)

23278

BLYTHEVILLE, AR (CON'T)

BLYTHEVILLE MUNI (HKA)

TAKEOFF MINIMUMS AND (OBSTACLE) DEPARTURE PROCEDURES

ORIG 05JUN08 (08157) (FAA)

TAKEOFF OBSTACLE NOTES:

Rwy 18, tree 487' from DER, 345' left of centerline, 100' AGL/364' MSL.

Tree 1780' from DER, 748' right of centerline, 100' AGL/364' MSL.

Rwy 36, tree 2393' from DER, 825' right of centerline, 100' AGL/359' MSL.**BOISE CITY, OK**

BOISE CITY (17K)

TAKEOFF MINIMUMS AND (OBSTACLE) DEPARTURE PROCEDURES

ORIG 22OCT09 (09295) (FAA)

TAKEOFF OBSTACLE NOTES:

Rwy 22, hangars 243' from DER, 226' right of centerline, 35' AGL/4212' MSL.

Vehicle on road 566' from DER, right and left of centerline, up to 15' AGL/4192' MSL.

BRINKLEY, AR

FRANK FEDERER MEML (M36)

TAKEOFF MINIMUMS AND (OBSTACLE) DEPARTURE PROCEDURES

ORIG 20OCT11 (22139) (FAA)

DEPARTURE PROCEDURE:

Rwy 20, climb heading 204° to 700 before proceeding on course.

TAKEOFF OBSTACLE NOTES:

Rwy 2, trees beginning 425' from DER, 138' right of centerline, up to 100' AGL/299' MSL.

Trees beginning 680' from DER, 262' left of centerline, up to 100' AGL/299' MSL.

Rwy 20, trees and terrain beginning 27' from DER, 125' right of centerline, up to 100' AGL/319' MSL.

Trees and terrain beginning 82' from DER, 100' left of centerline, up to 100' AGL/319' MSL.

BRISTOW, OK

JONES MEML (3F7)

TAKEOFF MINIMUMS AND (OBSTACLE) DEPARTURE PROCEDURES

AMDT 5 10SEP20 (22139) (FAA)

TAKEOFF OBSTACLE NOTES:

Rwy 18, electrical system 16' from DER, 486' right of centerline, 35' AGL/887' MSL.

Terrain 37' from DER, 405' left of centerline, 871' MSL.

Terrain 66' from DER, 249' left of centerline, 874' MSL.

Trees beginning 191' from DER, 486' left of centerline, up to 28' AGL/890' MSL.

Trees beginning 232' from DER, 559' right of centerline, up to 47' AGL/903' MSL.

Trees beginning 312' from DER, 339' left of centerline, up to 36' AGL/899' MSL.

Trees beginning 384' from DER, 309' left of centerline, up to 41' AGL/904' MSL.

Tree, electrical system beginning 391' from DER, 483' right of centerline, up to 44' AGL/907' MSL.

Tree 450' from DER, 572' right of centerline, 44' AGL/909' MSL.

Trees beginning 509' from DER, 560' right of centerline, up to 49' AGL/913' MSL.

Trees beginning 697' from DER, 574' right of centerline, up to 42' AGL/915' MSL.

Tree 725' from DER, 638' right of centerline, 43' AGL/919' MSL.

Trees, electrical system, vehicles on road, buildings, pole beginning 773' from DER, 462' right of centerline, up to 42' AGL/920' MSL.

Trees, electrical system beginning 807' from DER, 115' left of centerline, up to 58' AGL/905' MSL.

Trees beginning 1082' from DER, 52' left of centerline, up to 46' AGL/912' MSL.

Electrical system, building beginning 1178' from DER, 732' right of centerline, up to 32' AGL/934' MSL.

Trees, electrical system beginning 1193' from DER, 434' right of centerline, up to 42' AGL/940' MSL.

Electrical system beginning 1227' from DER, 181' left of centerline, up to 53' AGL/918' MSL.

Pole 2879' from DER, 169' left of centerline, 72' AGL/951' MSL.

Pole 2890' from DER, 344' right of centerline, 77' AGL/955' MSL.

Transmission line 2894' from DER, 967' right of centerline, 70' AGL/960' MSL.

Poles beginning 2897' from DER, 809' right of centerline, up to 78' AGL/964' MSL.

Rwy 36, vehicles on road 35' from DER, 465' left of centerline, 807' MSL.

Tree, electrical system beginning 190' from DER, 492' left of centerline, up to 46' AGL/833' MSL.

Trees, electrical system beginning 238' from DER, 304' left of centerline, up to 51' AGL/839' MSL.

Electrical system 311' from DER, 314' right of centerline, 28' AGL/819' MSL.

Electrical system beginning 411' from DER, 255' right of centerline, up to 35' AGL/834' MSL.

Electrical system beginning 414' from DER, 295' right of centerline, up to 30' AGL/839' MSL.

Electrical system, vehicles on road, trees beginning 421' from DER, 252' right of centerline, up to 57' AGL/847' MSL.

Trees beginning 1012' from DER, 491' right of centerline, up to 72' AGL/849' MSL.

Trees beginning 1068' from DER, 535' right of centerline, up to 73' AGL/851' MSL.

Trees beginning 1143' from DER, 537' right of centerline, up to 75' AGL/853' MSL.

Trees beginning 1338' from DER, 546' right of centerline, up to 83' AGL/860' MSL.

Trees beginning 1446' from DER, 536' right of centerline, up to 85' AGL/863' MSL.

Trees beginning 1500' from DER, 558' right of centerline, up to 88' AGL/865' MSL.

Tree 1692' from DER, 453' left of centerline, 70' AGL/852' MSL.

Trees beginning 2063' from DER, 437' right of centerline, up to 90' AGL/870' MSL.

CON'T

TAKEOFF MINIMUMS, (OBSTACLE) DEPARTURE PROCEDURES, AND

DIVERSE VECTOR AREA (RADAR VECTORS)

23278

TAKEOFF MINIMUMS, (OBSTACLE) DEPARTURE PROCEDURES, AND DIVERSE VECTOR AREA (RADAR VECTORS)

23278

BRISTOW, OK (CON'T)

JONES MEML (3F7) (CON'T)

Rwy 36 (CON'T), tree 2066' from DER, 380' left of centerline, 84' AGL/861' MSL.
Tree 2185' from DER, 703' right of centerline, 95' AGL/871' MSL.
Trees beginning 2187' from DER, 359' left of centerline, up to 85' AGL/866' MSL.
Tree 2223' from DER, 606' right of centerline, 102' AGL/880' MSL.
Trees beginning 2298' from DER, 700' right of centerline, up to 106' AGL/882' MSL.
Tree 2337' from DER, 1033' left of centerline, 95' AGL/874' MSL.
Tree 3961' from DER, 450' left of centerline, 47' AGL/906' MSL.

BUFFALO, OK

BUFFALO MUNI (BFK)

TAKEOFF MINIMUMS AND (OBSTACLE) DEPARTURE PROCEDURES

ORIG 03JUN10 (10154) (FAA)

TAKEOFF OBSTACLE NOTES:

Rwy 17, vehicles on roadway, at DER, 458' right of centerline, up to 17' AGL/1816' MSL.
Trees beginning 907' from DER, left and right of centerline, up to 40' AGL/1829' MSL.
Rwy 35, vehicles on roadway, 30' from DER, 467' left of centerline, up to 17' AGL/1846' MSL.
Vehicles on roadway, 776' from DER, left and right of centerline, up to 17' AGL/1846' MSL.

BURNS FLAT, OK

CLINTON/SHERMAN (CSM)

TAKEOFF MINIMUMS AND (OBSTACLE) DEPARTURE PROCEDURES

ORIG-A 27APR17 (22027) (FAA)

TAKEOFF OBSTACLE NOTES:

Rwy 17L, tree 655' from DER, 317' left of centerline, 23' AGL/1932' MSL.
Rwy 17R, tree 1275' from DER, 620' right of centerline, 35' AGL/1954' MSL.
Rwy 35R, ATCT 2797' from DER, 188' right of centerline, 66' AGL/1985' MSL.
Tower 3017' from DER, 296' right of centerline, 85' AGL/1996' MSL.

CAMDEN, AR

HARRELL FLD (CDH)

TAKEOFF MINIMUMS AND (OBSTACLE) DEPARTURE PROCEDURES

AMDT 1 31MAY12 (22139) (FAA)

TAKEOFF OBSTACLE NOTES:

Rwy 1, trees beginning 27' from DER, 6' right of centerline, up to 84' AGL/224' MSL.
Trees beginning 163' from DER, 159' left of centerline, up to 85' AGL/255' MSL.
Vehicle on road 327' from DER, 273' left of centerline, 15' AGL/146' MSL.
Rwy 19, trees beginning 38' from DER, 88' left of centerline, up to 83' AGL/222' MSL.
Trees beginning 797' from DER, 305' right of centerline, up to 84' AGL/213' MSL.

CARLISLE, AR

CARLISLE MUNI (4M3)

TAKEOFF MINIMUMS AND (OBSTACLE) DEPARTURE PROCEDURES

ORIG 05JUN08 (08157) (FAA)

TAKEOFF OBSTACLE NOTES:

Rwy 9, trees 2966' from DER, 1135' right of centerline, 100' AGL/339' MSL.
Building 82' from DER, 331' left of centerline, 20' AGL/264' MSL.
Building 781' from DER, 565' right of centerline, 30' AGL/269' MSL.
Rwy 18, trees 306' from DER, across centerline, up to 100' AGL/344' MSL.
Road 674' from DER, across centerline, 17' AGL/262' MSL.
Rwy 27, trees 2668' from DER, 516' right of centerline, 100' AGL/344' MSL.
Rwy 36, road 396' from DER, across centerline, 15' AGL/259' MSL.

CHANDLER, OK

CHANDLER RGNL (CQB)

TAKEOFF MINIMUMS AND (OBSTACLE) DEPARTURE PROCEDURES

AMDT 1A 08NOV18 (18312) (FAA)

TAKEOFF OBSTACLE NOTES:

Rwy 17, bush 15' from DER, 459' left of centerline, 988' MSL.
Trees and ground beginning 18' from DER, 16' right of centerline, up to 45' AGL/1012' MSL.
Tree 78' from DER, 292' right of centerline, 47' AGL/1013' MSL.
Trees beginning 102' from DER, 254' right of centerline, up to 51' AGL/1016' MSL.
Power line and trees beginning 103' from DER, 456' left of centerline, up to 1007' MSL.
Rwy 35, tree 20' from DER, 188' left of centerline, 15' AGL/965' MSL.
Tree 32' from DER, 100' right of centerline, 964' MSL.
Tree 329' from DER, 574' right of centerline, 976' MSL.
Trees beginning 708' from DER, 510' left of centerline, up to 985' MSL.
Tree 717' from DER, 503' right of centerline, 982' MSL.

TAKEOFF MINIMUMS, (OBSTACLE) DEPARTURE PROCEDURES, AND DIVERSE VECTOR AREA (RADAR VECTORS)

23278

SC-1

TAKEOFF MINIMUMS, (OBSTACLE) DEPARTURE PROCEDURES, AND DIVERSE VECTOR AREA (RADAR VECTORS)

23278

CHICKASHA, OK

CHICKASHA MUNI (CHK)

TAKEOFF MINIMUMS AND (OBSTACLE) DEPARTURE PROCEDURES

ORIG-A 09SEPT21 (21252) (FAA)

TAKEOFF MINIMUMS:

Rwys 1, 2, 19, 20, NA— Environmental.

TAKEOFF OBSTACLE NOTES:

Rwy 18, trees beginning 272' from DER, 103' right of centerline, up to 94' AGL/1183' MSL.

Trees beginning 708' from DER, 507' left of centerline, up to 40' AGL/1169' MSL.

CLAREMORE, OK

CLAREMORE RGNL (GCM)

TAKEOFF MINIMUMS AND (OBSTACLE) DEPARTURE PROCEDURES

AMD T 1 01FEB18 (18032) (FAA)

TAKEOFF MINIMUMS:

Rwy 36, 300 - 1 ¾ or std. w/min. climb of 306' per NM to 1100.

TAKEOFF OBSTACLE NOTES:

Rwy 18, terrain 450' from DER, 505' left of centerline, 753' MSL.**Rwy 36**, tree 473' from DER, 342' left of centerline, 19' AGL/719' MSL.

Tree 1103' from DER, 510' right of centerline, 27' AGL/729' MSL.

Tree 1149' from DER, 478' left of centerline, 38' AGL/727' MSL.

Tree 1510' from DER, 241' right of centerline, 46' AGL/735' MSL.

Tree 1570' from DER, 557' right of centerline, 42' AGL/739' MSL.

Tree 1 NM from DER, 1917' left of centerline, 100' AGL/949' MSL.

CLARKSVILLE, AR

CLARKSVILLE MUNI (H35)

TAKEOFF MINIMUMS AND (OBSTACLE) DEPARTURE PROCEDURES

ORIG 01JUN78 (78152) (FAA)

TAKEOFF MINIMUMS:

Rwy 9, 400-2

DEPARTURE PROCEDURE:

Rwys 9, 27, climb on runway heading to 3500 prior to turning northbound.

CLINTON, AR

CLINTON MUNI (CCA)

TAKEOFF MINIMUMS AND (OBSTACLE) DEPARTURE PROCEDURES

ORIG 21JUL16 (22139) (FAA)

TAKEOFF MINIMUMS:

Rwy 31, NA—Obstacles.**Rwy 13**, std. w/min. climb of 320' per NM to 1400 or 1800-3 for VCOA.

DEPARTURE PROCEDURE:

Rwy 13, climb heading 132° to 1400 before turning.

VCOA:

Obtain ATC approval for VCOA when requesting IFR clearance. Climb in visual conditions to cross Clinton Muni at or above 2200 before proceeding on course.

TAKEOFF OBSTACLE NOTES:

Rwy 13, bldg, fence, tree, vehicle on rd, beginning 14' from DER, 168' right of centerline, up to 19' AGL/517' MSL.

Tower, ant ltd, vehicle on rd, tree, fence, pole, beginning 101' from DER, 2' right of centerline, up to 36' AGL/534' MSL.

Tree 348' from DER, 114' right of centerline, 51' AGL/537' MSL.

Trees, beginning 404' from DER, 47' right of centerline, up to 54' AGL/546' MSL.

Trees, beginning 452' from DER, 24' left of centerline, up to 65' AGL/552' MSL.

Trees, beginning 539' from DER, 259' right of centerline, up to 65' AGL/556' MSL.

Trees, beginning 600' from DER, 227' right of centerline, up to 78' AGL/565' MSL.

Trees, beginning 614' from DER, 256' right of centerline, up to 572' MSL.

Trees, beginning 749' from DER, 213' right of centerline, up to 84' AGL/573' MSL.

Trees, beginning 1280' from DER, 1' right of centerline, up to 91' AGL/582' MSL.

Trees, beginning 1810' from DER, 328' left of centerline, up to 75' AGL/593' MSL.

Trees, beginning 1834' from DER, 95' left of centerline, up to 82' AGL/602' MSL.

Tree 1880' from DER, 965' left of centerline, 55' AGL/604' MSL.

Trees, beginning 1883' from DER, 61' left of centerline, up to 72' AGL/608' MSL.

Trees, beginning 1902' from DER, 53' right of centerline, up to 104' AGL/619' MSL.

Tree 1984' from DER, 194' left of centerline, 73' AGL/625' MSL.

Trees, beginning 1987' from DER, 253' left of centerline, up to 80' AGL/636' MSL.

Tree, it pole, beginning 1997' from DER, 9' right of centerline, up to 79' AGL/642' MSL.

Trees, beginning 2007' from DER, 208' right of centerline, up to 643' MSL.

Tree, vehicle on rd, road, pole, terrain, bldg, beginning 2019' from DER, 0' from centerline, up to 649' MSL.

Tree 5104' from DER, 1513' right of centerline, 71' AGL/650' MSL.

Trees, beginning 5109' from DER, 594' right of centerline, up to 73' AGL/649' MSL.

Tree 5151' from DER, 396' right of centerline, 77' AGL/658' MSL.

Trees, beginning 5197' from DER, 30' right of centerline, up to 78' AGL/666' MSL.

Trees, beginning 5316' from DER, 130' left of centerline, up to 75' AGL/675' MSL.

CON'T

TAKEOFF MINIMUMS, (OBSTACLE) DEPARTURE PROCEDURES, AND DIVERSE VECTOR AREA (RADAR VECTORS)

23278

SC-1

TAKEOFF MINIMUMS, (OBSTACLE) DEPARTURE PROCEDURES, AND DIVERSE VECTOR AREA (RADAR VECTORS)

23278

CLINTON, AR (CON'T)

CLINTON MUNI (CCA) (CON'T)

Rwy 13 (CON'T), trees, beginning 5384' from DER, 82' left of centerline, up to 76' AGL/683' MSL.

Trees, beginning 5391' from DER, 33' left of centerline, up to 75' AGL/684' MSL.

Tree, pole, beginning 5541' from DER, 23' left of centerline, up to 73' AGL/693' MSL.

Trees, beginning 5705' from DER, 267' left of centerline, up to 80' AGL/703' MSL.

Tree, bldg, terrain, beginning 5791' from DER, 50' right of centerline, up to 83' AGL/709' MSL.

Tree, bldg, beginning 5856' from DER, 38' left of centerline, up to 86' AGL/720' MSL.

Tree, bldg, pole, beginning 5912' from DER, 373' left of centerline, up to 95' AGL/728' MSL.

Trees, beginning 5955' from DER, 212' right of centerline, up to 100' AGL/729' MSL.

Tree, vehicle on rd, bldg, pole, terrain, lt pole, beginning 5963' from DER, 12' left of centerline, up to 104' AGL/736' MSL.

Tree 1.8 NM from DER, 1680' left of centerline, 41' AGL/791' MSL.

Trees, beginning 1.8 NM from DER, 1659' left of centerline, up to 41' AGL/806' MSL.

Trees, beginning 1.9 NM from DER, 1656' left of centerline, up to 45' AGL/808' MSL.

Tree 1.9 NM from DER, 1786' left of centerline, 49' AGL/801' MSL.

HOLLEY MOUNTAIN AIRPARK (2A2)

TAKEOFF MINIMUMS AND (OBSTACLE) DEPARTURE PROCEDURES

ORIG 20NOV08 (08325) (FAA)

TAKEOFF OBSTACLE NOTES:

Rwy 5, numerous trees left and right of centerline, beginning 2' from DER, up to 100' AGL/1399' MSL.

Rwy 23, numerous trees left and right of centerline, beginning 38' from DER, up to 100' AGL/1359' MSL.

CLINTON, OK

CLINTON RGNL (CLK)

TAKEOFF MINIMUMS AND (OBSTACLE) DEPARTURE PROCEDURES

AMDT 1 29MAY14 (14149) (FAA)

TAKEOFF MINIMUMS:

Rwys 13, 31, NA-Environmental.

TAKEOFF OBSTACLE NOTES:

Rwy 17, lights 6' from DER, left and right of centerline, 2' AGL/1596' MSL.

Rwy 35, tree 614' from DER, 576' right of centerline, 25' AGL/1626' MSL.

COLT, AR

DELTA RGNL (DRP)

TAKEOFF MINIMUMS AND (OBSTACLE) DEPARTURE PROCEDURES

ORIG 29MAY14 (14149) (FAA)

TAKEOFF OBSTACLE NOTES:

Rwy 18, trees beginning 3044' from DER, 196' left of centerline, up to 83' AGL/312' MSL.

Rwy 36, trees beginning 2219' from DER, 991' right of centerline, up to 78' AGL/319' MSL.

CONWAY, AR

CONWAY RGNL (CXW)

TAKEOFF MINIMUMS AND (OBSTACLE) DEPARTURE PROCEDURES

ORIG 13NOV14 (22139) (FAA)

TAKEOFF MINIMUMS:

Rwy 22, std. w/min. climb of 250' per NM to 680.

DEPARTURE PROCEDURE:

Rwy 22, climbing right turn heading 260° to 1300 before proceeding on course.

CORNING, AR

CORNING MUNI (4M9)

TAKEOFF MINIMUMS AND (OBSTACLE) DEPARTURE PROCEDURES

ORIG 05MAY11 (11125) (FAA)

TAKEOFF OBSTACLE NOTES:

Rwy 18, power lines beginning 499' from DER, left and right of centerline, up to 30' AGL/319' MSL.

Vehicles on roadway beginning 534' from DER, left and right of centerline, up to 15' AGL/309' MSL.

Trees beginning 1067' from DER, 292' right of centerline, up to 100' AGL/379' MSL.

Rwy 36, hangar 149' from DER, 399' left of centerline, 25' AGL/317' MSL.

Vehicles on roadway beginning 535' from DER, left and right of centerline, up to 15' AGL/309' MSL.

Power lines 552' from DER, left and right of centerline, up to 30' AGL/324' MSL.

Trees beginning 1148' from DER, 793' right of centerline, up to 100' AGL/394' MSL.

Trees beginning 2570' from DER, 1167' left of centerline, up to 100' AGL/394' MSL.

TAKEOFF MINIMUMS, (OBSTACLE) DEPARTURE PROCEDURES, AND DIVERSE VECTOR AREA (RADAR VECTORS)

23278

SC-1



TAKEOFF MINIMUMS, (OBSTACLE) DEPARTURE PROCEDURES, AND DIVERSE VECTOR AREA (RADAR VECTORS)



23278

CROSSETT, AR

Z M JACK STELL FLD (CRT)

TAKEOFF MINIMUMS AND (OBSTACLE) DEPARTURE PROCEDURES

ORIG 28JUL11 (21196) (FAA)

TAKEOFF OBSTACLE NOTES:

Rwy 5, trees beginning 1382' from DER, left and right of centerline, up to 75' AGL/259' MSL.
Vehicle on road beginning 298' from DER, left and right of centerline, up to 15' AGL/199' MSL.
Terrain 69' from DER, 288' left of centerline, 187' MSL.

Rwy 23, trees beginning abeam DER, right and left of centerline, up to 75' AGL/253' MSL.
Hangar, fuel tanks and shed beginning 147' from DER, 434' left of centerline, up to 17' AGL/195' MSL.
Vehicle on road beginning 453' from DER, left and right of centerline, up to 15' AGL/193' MSL.

CUSHING, OK

CUSHING MUNI (CUH)

TAKEOFF MINIMUMS AND (OBSTACLE) DEPARTURE PROCEDURES

AMDT 1A 20AUG15 (15232) (FAA)

TAKEOFF MINIMUMS:

Rwys 2, 8, 11, 20, 26, 29, NA.

Rwy 36, 400-2 or std. w/ min. climb of 210' per NM to 1400.

DEPARTURE PROCEDURES:

Rwy 36, climb via heading 360° to 1400' before turning left.

TAKEOFF OBSTACLE NOTES:

Rwy 18, trees beginning 43' from DER, 459' left of centerline, up to 50' AGL/921' MSL.

Pole 341' from DER, 335' left of centerline, 36' AGL/907' MSL.

NAVAID 2' from DER, 30' left of centerline, 4' AGL/879' MSL.

Rwy 36, terrain 72' from DER, 116' right of centerline, 918' MSL.

Trees beginning 83' from DER, 5' right of centerline, up to 50' AGL/965' MSL.

Trees beginning 1114' from DER, 29' left of centerline, up to 50' AGL/1013' MSL.

Vehicles on roadway 1050' from DER, 96' left of centerline, up to 15' AGL/951' MSL.

Poles beginning 1117' from DER, 138' right of centerline, up to 22' AGL/1071' MSL.

Tower 2.16 NM from DER, 5370' left of centerline, 250' AGL/1263' MSL.

DANVILLE, AR

DANVILLE MUNI (32A)

TAKEOFF MINIMUMS AND (OBSTACLE) DEPARTURE PROCEDURES

ORIG-A 03NOV22 (22307) (FAA)

TAKEOFF MINIMUMS:

Rwy 11, NA-Environmental.

Rwy 29, std. w/min. climb of 340' per NM to 4100 or 1700-3 for VCOA.

VCOA:

Rwy 29, obtain ATC approval for VCOA when requesting IFR clearance. Climb in visual conditions to cross Danville Muni at or above 1900 before proceeding on course.

TAKEOFF OBSTACLE NOTES:

Rwy 29, tree, vehicles on road, beginning 3' from DER, 302' left of centerline, up to 27' AGL/395' MSL.

Grd, beginning 7' from DER, 466' right of centerline, up to 372' MSL.

Tree, grd, beginning 24' from DER, 144' right of centerline, up to 16' AGL/386' MSL.

Tree, pole, beginning 76' from DER, 267' left of centerline, up to 65' AGL/431' MSL.

Tree, vehicles on road, pole, beginning 87' from DER, 184' left of centerline, up to 95' AGL/461' MSL.

Pole, tree, beginning 225' from DER, 490' right of centerline, up to 25' AGL/401' MSL.

Tree, fence, beginning 1013' from DER, 537' right of centerline, up to 51' AGL/431' MSL.

Tree, vehicles on road, beginning 984' from DER, 653' right of centerline, up to 30' AGL/426' MSL.

Tree, fence, beginning 1013' from DER, 537' right of centerline, up to 51' AGL/431' MSL.

Tree, pole, vehicles on road, ant, beginning 1035' from DER, 457' right of centerline, up to 45' AGL/432' MSL.

Tree, pole, vehicles on road, beginning 1321' from DER, 341' right of centerline, up to 62' AGL/444' MSL.

Tree, vehicles on road, beginning 1886' from DER, 106' right of centerline, up to 51' AGL/445' MSL.

Tree 1996' from DER, 742' right of centerline, 77' AGL/454' MSL.

Tree, vehicles on road, beginning 2009' from DER, 482' right of centerline, up to 50' AGL/454' MSL.

Trees, beginning 2013' from DER, 290' right of centerline, up to 80' AGL/461' MSL.

Trees, beginning 2054' from DER, 115' right of centerline, up to 75' AGL/468' MSL.

Trees, beginning 2236' from DER, 164' right of centerline, up to 79' AGL/469' MSL.

22 FEB 2024 to 21 MAR 2024

22 FEB 2024 to 21 MAR 2024



TAKEOFF MINIMUMS, (OBSTACLE) DEPARTURE PROCEDURES, AND DIVERSE VECTOR AREA (RADAR VECTORS)



23278

SC-1

TAKEOFF MINIMUMS, (OBSTACLE) DEPARTURE PROCEDURES, AND DIVERSE VECTOR AREA (RADAR VECTORS)

23278

DE QUEEN, AR

J. LYNN HELMS SEVIER COUNTY (DEQ)

TAKEOFF MINIMUMS AND (OBSTACLE) DEPARTURE PROCEDURES

AMDT 1A 10MAR11 (11069) (FAA)

TAKEOFF MINIMUMS:

Rwy 8, 400-2 or std. w/ min. climb of 378' per NM to 900.

TAKEOFF OBSTACLE NOTES:

Rwy 8, tower 1.36 NM from DER, 1350' right of centerline, 198' AGL/598' MSL.

Rwy 26, multiple trees and poles beginning 126' from DER, 64' left of centerline, up to 92' AGL/432' MSL.

Multiple trees and pole beginning 241' from DER, 98' right of centerline, up to 96' AGL/436' MSL.

DECATUR, AR

CRYSTAL LAKE (5M5)

TAKEOFF MINIMUMS AND (OBSTACLE) DEPARTURE PROCEDURES

AMDT 1A 15OCT15 (15288) (FAA)

TAKEOFF MINIMUMS:

Rwy 13, NA-obstacles.

TAKEOFF OBSTACLE NOTES:

Rwy 31, trees beginning 107' from DER, 64' left of centerline, up to 88' AGL/1239' MSL.

Pole 235' from DER, 353' left of centerline, 32' AGL/1161' MSL.

Pole 241' from DER, 465' left of centerline, 31' AGL/1162' MSL.

Building 1246' from DER, 519' left of centerline, 12' AGL/1187' MSL.

Train 470' from DER, 322' left of centerline, 23' AGL/1202' MSL.

Trees beginning 1216' from DER, 10' left of centerline, up to 103' AGL/1263' MSL.

Trees beginning 2252' from DER, 7' left of centerline, up to 100' AGL/1265' MSL.

Pole 199' from DER, 375' right of centerline, 44' AGL/1162' MSL.

Trees beginning 104' from DER, 89' right of centerline, up to 98' AGL/1221' MSL.

Pole 819' from DER, 633' right of centerline, 36' AGL/1181' MSL.

Trees beginning 1279' from DER, 7' right of centerline, up to 103' AGL/1242' MSL.

Trees beginning 2208' from DER, 59' right of centerline, up to 92' AGL/1267' MSL.

DE WITT, AR

DE WITT MUNI/WHITCOMB FLD (5M1)

TAKEOFF MINIMUMS AND (OBSTACLE) DEPARTURE PROCEDURES

ORIG 19MAY22 (22139) (FAA)

TAKEOFF OBSTACLE NOTES:

Rwy 18, tree 31' from DER, 285' right of centerline, 11' AGL/197' MSL.

Trees beginning 32' from DER, 247' left of centerline, up to 8' AGL/195' MSL.

Tree 90' from DER, 192' right of centerline, 14' AGL/198' MSL.

Trees beginning 140' from DER, 194' right of centerline, up to 22' AGL/208' MSL.

Rwy 36, fence 7' from DER, 249' right of centerline, 191' MSL.

Poles, buildings beginning 12' from DER, 336' left of centerline, up to 212' MSL.

Wind indicator 119' from DER, 176' right of centerline, 29' AGL/218' MSL.

Poles beginning 358' from DER, 383' left of centerline, up to 221' MSL.

Poles beginning 425' from DER, 246' right of centerline, up to 222' MSL.

Pole, vehicle on road beginning 449' from DER, 278' left of centerline, up to 223' MSL.

Pole 486' from DER, 573' right of centerline, 224' MSL.

Pole 547' from DER, 458' right of centerline, 41' AGL/228' MSL.

DUMAS, AR

BILLY FREE MUNI (0M0)

TAKEOFF MINIMUMS AND (OBSTACLE) DEPARTURE PROCEDURES

AMDT 1 30JAN20 (20030) (FAA)

TAKEOFF OBSTACLE NOTES:

Rwy 18, traverse way beginning 71' from DER, 407' left of centerline, up to 18' AGL/178' MSL.

Tree 85' from DER, 347' left of centerline, 54' AGL/213' MSL.

Tree 95' from DER, 478' left of centerline, 63' AGL/222' MSL.

Traverse way 163' from DER, 502' right of centerline, 17' AGL/176' MSL.

Tree 1415' from DER, 422' right of centerline, 54' AGL/213' MSL.

Tree 1429' from DER, 608' right of centerline, 58' AGL/216' MSL.

Trees beginning 1442' from DER, 853' right of centerline, up to 66' AGL/225' MSL.

Rwy 36, terrain 83' from DER, 237' left of centerline, 166' MSL.

Traverse way 197' from DER, 287' left of centerline, 15' AGL/178' MSL.

Trees beginning 253' from DER, 335' left of centerline, up to 48' AGL/210' MSL.

Tree, pole beginning 263' from DER, 269' right of centerline, up to 52' AGL/216' MSL.

Trees beginning 1319' from DER, 456' left of centerline, up to 53' AGL/217' MSL.

Tree 1611' from DER, 228' right of centerline, 54' AGL/219' MSL.

Trees beginning 1674' from DER, 83' right of centerline, up to 64' AGL/225' MSL.

Tree 1838' from DER, 302' right of centerline, 76' AGL/237' MSL.

Trees beginning 1889' from DER, 150' right of centerline, up to 74' AGL/239' MSL.

Trees beginning 1960' from DER, 225' left of centerline, up to 82' AGL/246' MSL.

TAKEOFF MINIMUMS, (OBSTACLE) DEPARTURE PROCEDURES, AND DIVERSE VECTOR AREA (RADAR VECTORS)

23278

SC-1



23278

TAKEOFF MINIMUMS, (OBSTACLE) DEPARTURE PROCEDURES, AND DIVERSE VECTOR AREA (RADAR VECTORS)



DUNCAN, OK

HALLIBURTON FLD (DUC)

TAKEOFF MINIMUMS AND (OBSTACLE) DEPARTURE PROCEDURES

AMDT 1 23SEP10 (22139) (FAA)

TAKEOFF MINIMUMS:

Rwy 35, 500-2¼, or std. with a min. climb of 280' per NM to 1700.

TAKEOFF OBSTACLE NOTES:

Rwy 17, multiple power poles beginning 978' from DER, 702' left of centerline, up to 60' AGL/1129' MSL.

Multiple power poles beginning 945' from DER, 613' right of centerline, up to 60' AGL/1149' MSL.

Multiple trees beginning 1704' from DER, 769' left of centerline, up to 100' AGL/1169' MSL.

Rwy 35, multiple trees beginning 1934' from DER, left to right of centerline, up to 100' AGL/1219' MSL.

Bush 7' from DER, 445' right of centerline, 9' AGL/1119' MSL.

Tower 1.92 NM from DER, 2453' left of centerline, 362' AGL/1471' MSL.

DURANT, OK

DURANT RGNL/EAKER FLD (DUA)

TAKEOFF MINIMUMS AND (OBSTACLE) DEPARTURE PROCEDURES

AMDT 1 05DEC19 (21336) (FAA)

TAKEOFF OBSTACLE NOTES:

Rwy 17, building 24' from DER, 361' left of centerline, 4' AGL/697' MSL.

Tree 93' from DER, 312' right of centerline, 22' AGL/711' MSL.

Tree 139' from DER, 535' right of centerline, 29' AGL/716' MSL.

Rwy 35, sign 24' from DER, 201' left of centerline, 3' AGL/703' MSL.

EL DORADO, AR

SOUTH ARKANSAS RGNL AT GOODWIN FLD (ELD)

TAKEOFF MINIMUMS AND (OBSTACLE) DEPARTURE PROCEDURES

AMDT 2A 01FEB18 (21140) (FAA)

TAKEOFF OBSTACLE NOTES:

Rwy 4, tree 1335' from DER, 620' right of centerline, 298' MSL.

Tree 1337' from DER, 692' right of centerline, 304' MSL.

Tree 2811' from DER, 657' right of centerline, 331' MSL.

Tree 3601' from DER, 685' left of centerline, 353' MSL.

Rwy 13, tree 83' from DER, 373' left of centerline, 271' MSL.

Tree 353' from DER, 239' left of centerline, 282' MSL.

Trees beginning 408' from DER, 261' right of centerline, up to 296' MSL.

Tree 409' from DER, 273' left of centerline, 295' MSL.

Trees beginning 657' from DER, 315' left of centerline, up to 309' MSL.

Tree 763' from DER, 346' right of centerline, 304' MSL.

Tree 1302' from DER, 421' right of centerline, 318' MSL.

Tree 2311' from DER, 280' right of centerline, 345' MSL.

Rwy 31, tree 77' from DER, 248' right of centerline, 325' MSL.

Trees beginning 216' from DER, 261' left of centerline, up to 326' MSL.

Tree 578' from DER, 294' right of centerline, 326' MSL.

Trees beginning 977' from DER, 25' left of centerline, up to 353' MSL.

Tree 1029' from DER, 352' right of centerline, 335' MSL.

Tree 2330' from DER, 304' right of centerline, 399' MSL.

Tree 2581' from DER, 572' right of centerline, 406' MSL.

EL RENO, OK

EL RENO RGNL (RQO)

TAKEOFF MINIMUMS AND (OBSTACLE) DEPARTURE PROCEDURES

ORIG 10APR08 (08101) (FAA)

TAKEOFF MINIMUMS:

Rwy 18, 36, NA-Environmental.

Rwy 35, 200-1 or std. w/ min. climb of 300' per NM to 1700.

TAKEOFF OBSTACLE NOTES:

Rwy 17, vehicle on road 444' from DER, on centerline, 17' AGL/1436' MSL.

Rwy 35, power lines, 1800' from DER, on centerline, 80' AGL/1519' MSL.

22 FEB 2024 to 21 MAR 2024

22 FEB 2024 to 21 MAR 2024



23278

TAKEOFF MINIMUMS, (OBSTACLE) DEPARTURE PROCEDURES, AND DIVERSE VECTOR AREA (RADAR VECTORS)



SC-1

TAKEOFF MINIMUMS, (OBSTACLE) DEPARTURE PROCEDURES, AND DIVERSE VECTOR AREA (RADAR VECTORS)

23278

ELK CITY, OK

ELK CITY RGNL BUSINESS (ELK)

TAKEOFF MINIMUMS AND (OBSTACLE) DEPARTURE PROCEDURES

AMDT 1A 07DEC17 (17341) (FAA)

TAKEOFF OBSTACLE NOTES:

- Rwy 17, sign 385' from DER, 403' right of centerline, 16' AGL/1986' MSL.
- Pole beginning 414' from DER, 551' right of centerline, up to 35' AGL/2000' MSL.
- Pole 484' from DER, 339' right of centerline, 31' AGL/2001' MSL.
- Poles beginning 492' from DER, 477' right of centerline, up to 35' AGL/2004' MSL.
- Road beginning 492' from DER, 1' left of centerline, up to 1987' MSL.
- Tree 512' from DER, 518' left of centerline, 66' AGL/2006' MSL.
- Poles beginning 618' from DER, 274' right of centerline, up to 38' AGL/2007' MSL.
- Rwy 35, fence beginning 52' from DER, 377' right of centerline, up to 10' AGL/2017' MSL.
- Pole beginning 191' from DER, 465' left of centerline, up to 35' AGL/2020' MSL.
- Fence 386' from DER, 275' left of centerline, 9' AGL/2024' MSL.
- Tree 543' from DER, 270' left of centerline, 35' AGL/2027' MSL.

ENID, OK

ENID WOODRING RGNL (WDG)

TAKEOFF MINIMUMS AND (OBSTACLE) DEPARTURE PROCEDURES

AMDT 4 10DEC15 (15344) (FAA)

TAKEOFF OBSTACLE NOTES:

- Rwy 13, trees beginning 107' from DER, 182' right of centerline, up to 100' AGL/1269' MSL.
- Trees beginning 840' from DER, 248' left of centerline, up to 100' AGL/1289' MSL.
- Rwy 31, vehicle on road 21' from DER, 415' right of centerline, 15' AGL/1171' MSL.
- Vehicle on road 417' from DER, 85' left of centerline, 15' AGL/1174' MSL.
- Rwy 35, fence 205' from DER, 489' right of centerline, 7' AGL/1175' MSL.
- Vehicle on road beginning 293' from DER, 209' right of centerline, 15' AGL/1187' MSL.
- Train on railroad tracks beginning 369' from DER, left and right of centerline, 23' AGL/1190' MSL.
- Trees beginning 336' from DER, 95' right of centerline, 24' AGL/1191' MSL.

FAIRVIEW, OK

FAIRVIEW MUNI (6K4)

TAKEOFF MINIMUMS AND (OBSTACLE) DEPARTURE PROCEDURES

AMDT 5 05DEC19 (19339) (FAA)

TAKEOFF MINIMUMS:

- Rwy 17, 300-1¼ or std. w/min. climb of 350' per NM to 1600.

DEPARTURE PROCEDURE:

- Rwy 17, climb heading 177° to 1800 before turning left.

TAKEOFF OBSTACLE NOTES:

- Rwy 17, terrain 1' from DER, 494' right of centerline, 1273' MSL.
- Trees, vehicle on road, pole, buildings and sign beginning 38' from DER, 285' left of centerline, up to 50' AGL/1321' MSL.
- Utility pole 192' from DER, 417' right of centerline, 5' AGL/1279' MSL.
- Tank and terrain beginning 217' from DER, 409' right of centerline, up to 8' AGL/1281' MSL.
- Poles, buildings, vehicle on road, tank, antenna, electrical system and trees beginning 239' from DER, 193' right of centerline, up to 35' AGL/1308' MSL.
- Trees beginning 377' from DER, 418' left of centerline, up to 55' AGL/1327' MSL.
- Trees, vehicle on road, buildings, poles and electrical system beginning 394' from DER, 44' left of centerline, up to 65' AGL/1335' MSL.
- Pole, electrical system and tree beginning 454' from DER, 452' right of centerline, up to 36' AGL/1311' MSL.
- Pole, trees and building beginning 520' from DER, 213' right of centerline, up to 43' AGL/1317' MSL.
- Trees, electrical system, poles, vehicle on road and buildings beginning 526' from DER, 193' right of centerline, up to 46' AGL/1320' MSL.
- Trees, buildings, electrical system and poles beginning 698' from DER, 192' right of centerline, up to 50' AGL/1325' MSL.
- Trees and poles beginning 1010' from DER, 14' right of centerline, up to 58' AGL/1333' MSL.
- Trees and poles beginning 1174' from DER, 174' left of centerline, up to 71' AGL/1341' MSL.
- Trees, poles, building and electrical system beginning 1209' from DER, 9' right of centerline, up to 68' AGL/1344' MSL.
- Trees beginning 1249' from DER, 34' left of centerline, up to 76' AGL/1346' MSL.
- Tree 1378' from DER, 713' left of centerline, 82' AGL/1353' MSL.
- Trees and pole beginning 1397' from DER, 27' left of centerline, up to 86' AGL/1356' MSL.
- Trees, poles and antenna beginning 1675' from DER, 31' right of centerline, up to 73' AGL/1351' MSL.
- Tree 2927' from DER, 227' right of centerline, 70' AGL/1352' MSL.
- Grain elevator beginning 4385' from DER, 1445' right of centerline, up to 172' AGL/1463' MSL.
- Antenna 6033' from DER, 404' right of centerline, 136' AGL/1432' MSL.

CON'T

22 FEB 2024 to 21 MAR 2024

22 FEB 2024 to 21 MAR 2024

TAKEOFF MINIMUMS, (OBSTACLE) DEPARTURE PROCEDURES, AND DIVERSE VECTOR AREA (RADAR VECTORS)

23278

SC-1

TAKEOFF MINIMUMS, (OBSTACLE) DEPARTURE PROCEDURES, AND DIVERSE VECTOR AREA (RADAR VECTORS)

23278

FAIRVIEW, OK (CON'T)

FAIRVIEW MUNI (6K4) (CON'T)

Rwy 35, brush beginning 5' from DER, 315' right of centerline, up to 4' AGL/1266' MSL.
Sign and fence beginning 13' from DER, 200' left of centerline, up to 3' AGL/1267' MSL.
Brush beginning 65' from DER, 288' right of centerline, up to 4' AGL/1268' MSL.
Tree 698' from DER, 488' left of centerline, 35' AGL/1298' MSL.
Trees beginning 699' from DER, 351' left of centerline, up to 34' AGL/1300' MSL.
Tree 799' from DER, 674' left of centerline, 41' AGL/1308' MSL.
Antenna and tree beginning 801' from DER, 703' left of centerline, up to 47' AGL/1314' MSL.
Tree 839' from DER, 691' left of centerline, 48' AGL/1316' MSL.
Tree 2029' from DER, 50' right of centerline, 57' AGL/1319' MSL.
Tree 2133' from DER, 160' left of centerline, 62' AGL/1326' MSL.

FAYETTEVILLE, AR

DRAKE FLD (FYV)

TAKEOFF MINIMUMS AND (OBSTACLE) DEPARTURE PROCEDURES

AMDT 7 07DEC17 (21112) (FAA)

TAKEOFF MINIMUMS:

Rwy 16, 400-2 w/min. climb of 320' per NM to 2500 or std. w/min. climb of 530' per NM to 2000 or 1600-3 for VCOA.
Rwy 34, 300-1 or std. w/min. climb of 680' per NM to 1700.

DEPARTURE PROCEDURE:

Rwy 16, climb heading 167° to 2700 before turning right. Climb heading 167° to 3400 before turning left.
Rwy 34, climb heading 347° to 2700 before proceeding on course.

VCOA:

Rwy 16, obtain ATC approval for VCOA when requesting IFR clearance. Climb in visual conditions to cross Drake Fld at or above 2700 before proceeding on course.

TAKEOFF OBSTACLE NOTES:

Rwy 16, tree 73' from DER, 404' left of centerline, 1252' MSL.
Tree 196' from DER, 354' left of centerline, 1258' MSL.
Trees beginning 833' from DER, 562' right of centerline, up to 38' AGL/1269' MSL.
Trees beginning 1184' from DER, 106' left of centerline, up to 114' AGL/1342' MSL.
Tree 2087' from DER, 467' right of centerline, 1301' MSL.
Tree 2104' from DER, 254' right of centerline, 1309' MSL.
Tree 2230' from DER, 869' right of centerline, 1320' MSL.
Tree 2513' from DER, 291' right of centerline, 1323' MSL.
Trees beginning 2882' from DER, 12' right of centerline, up to 103' AGL/1339' MSL.
Trees beginning 3024' from DER, 624' left of centerline, up to 85' AGL/1344' MSL.
Trees beginning 3096' from DER, 386' left of centerline, up to 94' AGL/1346' MSL.
Trees beginning 3599' from DER, 1166' left of centerline, up to 78' AGL/1362' MSL.
Trees beginning 3720' from DER, 1009' left of centerline, up to 78' AGL/1377' MSL.
Trees beginning 4087' from DER, 390' left of centerline, up to 61' AGL/1415' MSL.
Trees beginning 4646' from DER, 498' left of centerline, up to 76' AGL/1452' MSL.
Trees, terrain, poles and transmission lines beginning 4814' from DER, 350' left of centerline, up to 67' AGL/1500' MSL.
Tree and terrain beginning 5093' from DER, 1319' left of centerline, up to 70' AGL/1522' MSL.
Trees, terrain and buildings beginning 5180' from DER, 162' left of centerline, up to 1571' MSL.
Trees, terrain, building, poles, transmission lines, tower and vehicles on road beginning 5579' from DER, 165' left of centerline, up to 1606' MSL.
Trees, terrain, buildings, vehicles on road, poles, fences and transmission line beginning 1 NM from DER, 22' left of centerline, up to 1623' MSL.
Trees beginning 1.1 NM from DER, 14' right of centerline, up to 71' AGL/1459' MSL.
Trees beginning 1.3 NM from DER, 23' right of centerline, up to 77' AGL/1483' MSL.
Rwy 34, fence and terrain beginning on centerline, 218' left of centerline, up to 3' AGL/1256' MSL.
Vehicles on road, terrain, fence, electrical system and pole beginning 5' from DER, 197' left of centerline, up to 1269' MSL.
Tree 659' from DER, 588' right of centerline, 1280' MSL.
Tree 1170' from DER, 690' right of centerline, 42' AGL/1289' MSL.
Tree 1794' from DER, 329' right of centerline, 1302' MSL.
Tree 1836' from DER, 320' right of centerline, 54' AGL/1307' MSL.
Tree 2308' from DER, 752' right of centerline, 45' AGL/1321' MSL.
Tree 2459' from DER, 279' left of centerline, 71' AGL/1323' MSL.
Trees beginning 2514' from DER, 483' right of centerline, up to 37' AGL/1334' MSL.
Tree 2590' from DER, 802' right of centerline, 39' AGL/1336' MSL.
Trees beginning 2594' from DER, 353' left of centerline, up to 65' AGL/1324' MSL.
Trees, pole and transmission line beginning 2632' from DER, 418' right of centerline, up to 39' AGL/ 1360' MSL.
Tree 2661' from DER, 769' left of centerline, 85' AGL/1343' MSL.
Trees and terrain beginning 2844' from DER, 562' right of centerline, up to 38' AGL/1397' MSL.
Trees, poles, transmission lines and terrain beginning 3057' from DER, 627' right of centerline, up to 55' AGL/1445' MSL.
Terrain and tree beginning 3268' from DER, 750' right of centerline, up to 1496' MSL.
Trees, terrain, poles and transmission lines beginning 3317' from DER, 393' right of centerline, up to 42' AGL/1532' MSL.
Trees beginning 4198' from DER, 1051' right of centerline, up to 59' AGL/1423' MSL.

22 FEB 2024 to 21 MAR 2024

22 FEB 2024 to 21 MAR 2024

TAKEOFF MINIMUMS, (OBSTACLE) DEPARTURE PROCEDURES, AND DIVERSE VECTOR AREA (RADAR VECTORS)

23278

SC-1

TAKEOFF MINIMUMS, (OBSTACLE) DEPARTURE PROCEDURES, AND DIVERSE VECTOR AREA (RADAR VECTORS)

23278

FAYETTEVILLE/SPRINGDALE/ROGERS, AR

NORTHWEST ARKANSAS NTL (XNA)

TAKEOFF MINIMUMS AND (OBSTACLE) DEPARTURE PROCEDURES

AMDT 5 20APR23 (23110) (FAA)

DEPARTURE PROCEDURE:

Rwys 34L/R, climb on heading 339° to 1800 before turning left.

TAKEOFF OBSTACLE NOTES:

Rwy 34L, tree 119' from DER, 445' left of centerline, 5' AGL/1299' MSL.

Tree 802' from DER, 693' left of centerline, 42' AGL/1327' MSL.

Tree 2178' from DER, 751' left of centerline, 1350' MSL.

FLIPPIN, AR

MARION COUNTY RGNL (FLP)

TAKEOFF MINIMUMS AND (OBSTACLE) DEPARTURE PROCEDURES

AMDT 1 02MAR17 (17061) (FAA)

TAKEOFF MINIMUMS:

Rwy 22, 300-1¼ or std. w/ min. climb of 222' per NM to 900, or alternatively, with std. takeoff minimums and a normal 200' per NM gradient, takeoff must occur no later than 1600' prior to DER.

DEPARTURE PROCEDURE:

Rwy 22, climb heading 231° to 1600 before turning right.

TAKEOFF OBSTACLE NOTES:

Rwy 4, vehicle on road 2' from DER, 276' left of centerline, 10' AGL/733' MSL.

Vehicle on road 14' from DER, 494' right of centerline, 26' AGL/724' MSL.

Trees, poles, vehicle on road, beginning 153' from DER, 276' left of centerline, up to 71' AGL/799' MSL.

Trees, beginning 223' from DER, 325' right of centerline, up to 77' AGL/777' MSL.

Trees, beginning 491' from DER, 226' right of centerline, up to 81' AGL/781' MSL.

Trees, pole, beginning 725' from DER, 45' left of centerline, up to 73' AGL/800' MSL.

Trees, beginning 1492' from DER, 61' left of centerline, up to 83' AGL/809' MSL.

Trees, beginning 1827' from DER, 165' right of centerline, up to 78' AGL/793' MSL.

Trees, beginning 2266' from DER, 14' right of centerline, up to 66' AGL/803' MSL.

Trees, beginning 2430' from DER, 51' right of centerline, up to 99' AGL/804' MSL.

Trees, beginning 2633' from DER, 248' right of centerline, up to 98' AGL/809' MSL.

T-1 twr, beginning 3317' from DER, 1120' right of centerline, up to 100' AGL/819' MSL.

Tree 3334' from DER, 123' left of centerline, 85' AGL/818' MSL.

T-1 twr, pole, beginning 3781' from DER, 536' right of centerline, up to 100' AGL/840' MSL.

Rwy 22, vehicle on road 2' from DER, 244' left of centerline, 17' AGL/654' MSL.

Grd 2' from DER, 496' left of centerline, 675' MSL.

Tree 321' from DER, 458' left of centerline, 61' AGL/694' MSL.

Trees beginning 325' from DER, 198' left of centerline, up to 63' AGL/699' MSL.

Tree 369' from DER, 486' right of centerline, 24' AGL/669' MSL.

Pole beginning 369' from DER, 490' right of centerline, up to 25' AGL/671' MSL.

Building, pole beginning 387' from DER, 299' right of centerline, up to 26' AGL/672' MSL.

Buildings, trees, beginning 672' from DER, 99' right of centerline, up to 37' AGL/683' MSL.

Building, chy beginning 1095' from DER, 582' right of centerline, up to 57' AGL/701' MSL.

Trees beginning 1303' from DER, 26' right of centerline, up to 67' AGL/709' MSL.

Tree 1413' from DER, 18' left of centerline, 51' AGL/698' MSL.

Trees beginning 1619' from DER, 55' right of centerline, up to 63' AGL/713' MSL.

Tree, pole beginning 1673' from DER, 140' left of centerline, up to 63' AGL/732' MSL.

Trees beginning 2001' from DER, 195' right of centerline, up to 66' AGL/721' MSL.

Tree, poles beginning 2099' from DER, 203' left of centerline, up to 71' AGL/746' MSL.

Pole 2438' from DER, 744' left of centerline, 100' AGL/779' MSL.

Trees beginning 2461' from DER, 25' left of centerline, up to 92' AGL/804' MSL.

Trees beginning 2470' from DER, 330' right of centerline, up to 97' AGL/760' MSL.

Trees beginning 2913' from DER, 18' right of centerline, up to 65' AGL/766' MSL.

Trees beginning 3571' from DER, 55' right of centerline, up to 78' AGL/770' MSL.

Tree 1 NM from DER, 836' right of centerline, 88' AGL/832' MSL.

FORT SMITH, AR

FORT SMITH RGNL (FSM)

TAKEOFF MINIMUMS AND (OBSTACLE) DEPARTURE PROCEDURES

AMDT 5 15JUN23 (23166) (FAA)

TAKEOFF MINIMUMS:

Rwy 2, 300-1 3/8 or std. w/min. climb of 319' per NM to 700.**Rwy 8**, 300-1½ or std. w/min. climb of 304' per NM to 800.**Rwy 20**, 300-1 3/8 or std. w/min. climb of 231' per NM to 700 or alternatively, with std. takeoff minimums and a normal 200' per NM climb gradient, takeoff must occur no later than 1800' prior to DER.**Rwy 26**, 300-1 or std. w/min. climb of 346' per NM to 800 or alternatively, with std. takeoff minimums and a normal 200' per NM climb gradient, takeoff must occur no later than 2000' prior to DER.

DEPARTURE PROCEDURE:

Rwy 2, climb on heading 020° to 2300 before turning left.**Rwy 26**, climb on heading 260° to 1100 before turning right.

CONT

TAKEOFF MINIMUMS, (OBSTACLE) DEPARTURE PROCEDURES, AND DIVERSE VECTOR AREA (RADAR VECTORS)

23278

SC-1

TAKEOFF MINIMUMS, (OBSTACLE) DEPARTURE PROCEDURES, AND DIVERSE VECTOR AREA (RADAR VECTORS)

FORT SMITH, AR (CON'T) FORT SMITH RGNL (FSM) (CON'T)

TAKEOFF OBSTACLE NOTES:

Rwy 2, terrain 64' from DER, 489' left of centerline, 449' MSL.
Trees, poles beginning 824' from DER, 133' left of centerline, up to 52' AGL/498' MSL.
Pole 1131' from DER, 14' right of centerline, 36' AGL/478' MSL.
Pole 1164' from DER, 173' right of centerline, 39' AGL/480' MSL.
Tree 1295' from DER, 717' left of centerline, 53' AGL/501' MSL.
Tree 1301' from DER, 218' left of centerline, 65' AGL/508' MSL.
Trees beginning 1304' from DER, 195' left of centerline, up to 73' AGL/516' MSL.
Trees beginning 1327' from DER, 46' left of centerline, up to 74' AGL/519' MSL.
Tree 1427' from DER, 243' right of centerline, 45' AGL/484' MSL.
Tree 1433' from DER, 18' right of centerline, 49' AGL/491' MSL.
Trees beginning 1435' from DER, 6' right of centerline, up to 59' AGL/501' MSL.
Trees beginning 1596' from DER, 42' left of centerline, up to 73' AGL/522' MSL.
Trees beginning 1676' from DER, 51' left of centerline, up to 79' AGL/527' MSL.
Trees beginning 1798' from DER, 106' right of centerline, up to 60' AGL/502' MSL.
Trees beginning 1918' from DER, 134' left of centerline, up to 71' AGL/528' MSL.
Trees beginning 2163' from DER, 17' right of centerline, up to 64' AGL/508' MSL.
Trees beginning 2502' from DER, 9' left of centerline, up to 77' AGL/537' MSL.
Antenna, trees, towers, signs, poles, buildings beginning 4319' from DER, 70' left of centerline, up to 95' AGL/619' MSL.
Trees beginning 4989' from DER, 796' right of centerline, up to 582' MSL.
Trees beginning 5136' from DER, 794' right of centerline, up to 629' MSL.
Trees beginning 5300' from DER, 820' right of centerline, up to 630' MSL.
Trees beginning 5476' from DER, 321' right of centerline, up to 636' MSL.
Trees beginning 5824' from DER, 222' right of centerline, up to 644' MSL.
Trees, transmission line, pole beginning 5922' from DER, 1002' right of centerline, up to 649' MSL.
Trees beginning 1 NM from DER, 2177' right of centerline, up to 661' MSL.
Rwy 8, terrain beginning 101' from DER, 298' left of centerline, up to 465' MSL.
Tree 170' from DER, 235' right of centerline, 477' MSL.
Terrain beginning 315' from DER, 490' left of centerline, up to 466' MSL.
Trees beginning 1796' from DER, 613' left of centerline, up to 515' MSL.
Trees beginning 1894' from DER, 881' left of centerline, up to 518' MSL.
Trees beginning 2026' from DER, 783' left of centerline, up to 522' MSL.
Trees beginning 2291' from DER, 814' left of centerline, up to 536' MSL.
Trees beginning 2592' from DER, 754' left of centerline, up to 548' MSL.
Tree 2749' from DER, 965' left of centerline, 551' MSL.
Trees beginning 2827' from DER, 946' left of centerline, up to 555' MSL.
Tree 5278' from DER, 1909' right of centerline, 58' AGL/632' MSL.
Trees beginning 5305' from DER, 1685' right of centerline, up to 639' MSL.
Trees, pole beginning 5482' from DER, 1510' right of centerline, up to 78' AGL/656' MSL.
Trees, building, pole beginning 6008' from DER, 1566' right of centerline, up to 657' MSL.
Trees, pole, antenna beginning 1 NM from DER, 1191' right of centerline, up to 667' MSL.
Tower 1.2 NM from DER, 1997' right of centerline, 79' AGL/639' MSL.
Rwy 20, tree 108' from DER, 482' left of centerline, 452' MSL.
Trees beginning 627' from DER, 230' left of centerline, up to 24' AGL/467' MSL.
Traverse ways beginning 639' from DER, 204' left of centerline, up to 469' MSL.
Traverse way 696' from DER, 156' left of centerline, 470' MSL.
Tank, traverse way, tree beginning 704' from DER, 102' left of centerline, up to 34' AGL/480' MSL.
Tree 724' from DER, 77' right of centerline, 25' AGL/468' MSL.
Elevator, traverse way, trees beginning 744' from DER, 4' left of centerline, up to 38' AGL/482' MSL.
Traverse ways beginning 785' from DER, 96' right of centerline, up to 471' MSL.
Trees beginning 845' from DER, 10' right of centerline, up to 29' AGL/475' MSL.
Trees beginning 914' from DER, 18' right of centerline, up to 28' AGL/476' MSL.
Tree 923' from DER, 66' right of centerline, 31' AGL/479' MSL.
Trees beginning 924' from DER, 34' right of centerline, up to 32' AGL/480' MSL.
Trees beginning 1005' from DER, 77' right of centerline, up to 33' AGL/481' MSL.
Tree 1033' from DER, 122' left of centerline, 40' AGL/483' MSL.
Trees beginning 1048' from DER, 167' left of centerline, up to 484' MSL.
Tree 1086' from DER, 197' right of centerline, 35' AGL/482' MSL.
Trees beginning 1277' from DER, 106' left of centerline, up to 52' AGL/491' MSL.
Tree 1401' from DER, 441' left of centerline, 494' MSL.
Transmission line, pole beginning 1865' from DER, 693' left of centerline, up to 42' AGL/501' MSL.
Trees, transmission lines, poles beginning 1927' from DER, 266' left of centerline, up to 78' AGL/539' MSL.
Trees, poles, tower beginning 2035' from DER, 393' left of centerline, up to 76' AGL/544' MSL.
Elevator 2106' from DER, 968' right of centerline, 86' AGL/536' MSL.
Trees beginning 1 NM from DER, 1351' left of centerline, up to 627' MSL.
Rwy 26, traverse way 998' from DER, 719' right of centerline, 497' MSL.
Pole 1166' from DER, 762' right of centerline, 24' AGL/511' MSL.
Trees beginning 1311' from DER, 794' left of centerline, up to 511' MSL.
Pole, building beginning 1325' from DER, 792' right of centerline, up to 25' AGL/513' MSL.
Tree 1440' from DER, 780' left of centerline, 518' MSL.
Poles beginning 1459' from DER, 734' right of centerline, up to 24' AGL/515' MSL.
Pole 1646' from DER, 781' right of centerline, 34' AGL/520' MSL.
Poles beginning 1660' from DER, 819' right of centerline, up to 39' AGL/527' MSL.
CON'T

TAKEOFF MINIMUMS, (OBSTACLE) DEPARTURE PROCEDURES, AND DIVERSE VECTOR AREA (RADAR VECTORS)

TAKEOFF MINIMUMS, (OBSTACLE) DEPARTURE PROCEDURES, AND DIVERSE VECTOR AREA (RADAR VECTORS)

23278

FORT SMITH, AR (CON'T)

FORT SMITH RGNL (FSM) (CON'T)

Rwy 26 (CON'T), trees, building beginning 1815' from DER, 684' right of centerline, up to 547' MSL.
Trees, building beginning 2024' from DER, 692' right of centerline, up to 549' MSL.
Sign, trees beginning 2687' from DER, 742' right of centerline, up to 40' AGL/553' MSL.
Tree 3554' from DER, 248' left of centerline, 558' MSL.
Tower, water tower, tank beginning 4973' from DER, 208' left of centerline, up to 125' AGL/623' MSL.

FREDERICK, OK

FREDERICK RGNL (FDR)

TAKEOFF MINIMUMS AND (OBSTACLE) DEPARTURE PROCEDURES

ORIG 23SEP10 (10266) (FAA)

TAKEOFF OBSTACLE NOTES:

Rwy 3, vehicles on road 425' from DER, 231' right of centerline, 15' AGL/1269' MSL.
Rwy 12, vehicles on road 404' from DER, 229' left of centerline, 15' AGL/1254' MSL.

GOLDSBY, OK

DAVID JAY PERRY (1K4)

TAKEOFF MINIMUMS AND (OBSTACLE) DEPARTURE PROCEDURES

ORIG 25OCT07 (07298) (FAA)

TAKEOFF OBSTACLE NOTES:

Rwy 13, trees beginning 751' from DER, 481' left of centerline, up to 50' AGL/1209' MSL.
Tree 982' from DER, 730' right of centerline, 50' AGL/1189' MSL.
Terrain 101' from DER, 369' right of centerline, 1159' MSL.
Rwy 31, tree 1624' from DER, 550' right of centerline, 50' AGL/1219' MSL.
Rwy 35, tree 930' from DER, 45' left of centerline, 50' AGL/1199' MSL.
Road 905' from DER, 18' left of centerline, 15' AGL/1194' MSL.

GROVE, OK

GROVE RGNL (GMJ)

TAKEOFF MINIMUMS AND (OBSTACLE) DEPARTURE PROCEDURES

ORIG 25SEP08 (22195) (FAA)

TAKEOFF MINIMUMS:

Rwy 18, 200-1/4 or std. w/min. climb of 271' per NM to 1100.

TAKEOFF OBSTACLE NOTES:

Rwy 18, building 308' from DER, 321' left of centerline, 13' AGL/842' MSL.
Multiple buildings beginning 11' from DER, 325' right of centerline, 22' AGL/851' MSL.
Windsock 118' from DER, 325' right of centerline, 22' AGL/851' MSL.
Light 165' from DER, 420' left of centerline, 24' AGL/863' MSL.
Vehicle on road 598' from DER, 619' left of centerline, 15' AGL/854' MSL.
Vehicle on road 590' from DER, 499' right of centerline, 15' AGL/844' MSL.
Trees and poles beginning 33' from DER, 12' left of centerline, up to 100' AGL/1019' MSL.
Trees and poles beginning 252' from DER, 13' right of centerline, up to 40' AGL/869' MSL.
Rwy 36, rising terrain beginning 30' from DER, 277' left of centerline, up to 826' MSL.
Pole 316' from DER, 521' left of centerline, 20' AGL/859' MSL.
Trees beginning 151' from DER, 54' left of centerline, up to 100' AGL/939' MSL.
Trees beginning 109' from DER, 49' right of centerline, up to 85' AGL/884' MSL.

GUTHRIE, OK

GUTHRIE/EDMOND RGNL (GOK)

TAKEOFF MINIMUMS AND (OBSTACLE) DEPARTURE PROCEDURES

AMDT 1 17DEC09 (22027) (FAA)

TAKEOFF OBSTACLE NOTES:

Rwy 16, trees beginning 54' from DER, 286' right of centerline, up to 44' AGL/1087' MSL.

GUYMON, OK

GUYMON MUNI (GUY)

TAKEOFF MINIMUMS AND (OBSTACLE) DEPARTURE PROCEDURES

AMDT 1A 10SEP20 (20254) (FAA)

TAKEOFF MINIMUMS:

Rwys 6, 24, NA-environmental.
Rwy 18, 600-1/4 or std. w/ min. climb of 387' per NM to 3800.

DEPARTURE PROCEDURE:

Rwy 18, climb on heading 177° to 3800 before turning left.

TAKEOFF OBSTACLE NOTES:

Rwy 18, pole 155' from DER, 446' left of centerline, 30' AGL/3124' MSL.
Building 407' from DER, 463' right of centerline, 25' AGL/3131' MSL.
Tower 532' from DER, 484' right of centerline, 54' AGL/3157' MSL.
Rwy 36, fence 24' from DER, 400' right of centerline, 8' AGL/3110' MSL.

TAKEOFF MINIMUMS, (OBSTACLE) DEPARTURE PROCEDURES, AND DIVERSE VECTOR AREA (RADAR VECTORS)

23278

SC-1

TAKEOFF MINIMUMS, (OBSTACLE) DEPARTURE PROCEDURES, AND DIVERSE VECTOR AREA (RADAR VECTORS)

23278

HARRISON, AR

BOONE COUNTY (HRO)

TAKEOFF MINIMUMS AND (OBSTACLE) DEPARTURE PROCEDURES

AMDT 2A 26APR18 (18116) (FAA)

TAKEOFF MINIMUMS:

Rwy 18, 1400 - 3 or std. w/ min. climb of 320' per NM to 3200.

DEPARTURE PROCEDURE:

Rwy 18, climb on heading 182° to 2600 before turning.

TAKEOFF OBSTACLE NOTES:

Rwy 18, tree, vehicles on road, pole beginning 17' from DER, 482' right of centerline, up to 33' AGL/1396' MSL.

Rwy 36, vegetation, tree beginning 32' from DER, 444' left of centerline, up to 1367' MSL.

Fence 184' from DER, 498' left of centerline, 2' AGL/1369' MSL.

Tree 228' from DER, 545' left of centerline, 1378' MSL.

Tree 270' from DER, 524' right of centerline, 1376' MSL.

Tree 321' from DER, 520' left of centerline, 1379' MSL.

Trees beginning 448' from DER, 543' left of centerline, up to 1381' MSL.

Trees beginning 634' from DER, 333' left of centerline, up to 1384' MSL.

Tree 877' from DER, 365' left of centerline, 1388' MSL.

Tree 906' from DER, 334' left of centerline, 1394' MSL.

Trees beginning 969' from DER, 368' left of centerline, up to 1397' MSL.

Tree 1029' from DER, 368' left of centerline, 1399' MSL.

Trees beginning 1065' from DER, 186' left of centerline, up to 1403' MSL.

Trees beginning 1160' from DER, 217' left of centerline, up to 1405' MSL.

Tree 1576' from DER, 805' right of centerline, 1405' MSL.

HEBER SPRINGS, AR

HEBER SPRINGS MUNI (HBZ)

TAKEOFF MINIMUMS AND (OBSTACLE) DEPARTURE PROCEDURES

AMDT 1 10OCT19 (19283) (FAA)

TAKEOFF MINIMUMS:

Rwy 6, 500-3 or std. w/min. climb of 235' per NM to 1200.

DEPARTURE PROCEDURE:

Rwy 24, climb on heading 240° to 1200 before proceeding on course.

TAKEOFF OBSTACLE NOTES:

Rwy 6, trees beginning abeam DER, 190' right of centerline up to 80 AGL/700' MSL.

Trees beginning abeam DER, 240' left of centerline, up to 80' AGL/700' MSL.

Trees beginning 450' from DER, crossing runway extended centerline, up to 80 AGL/700' MSL.

Rwy 24, trees beginning abeam DER, 250' right of centerline up to 80 AGL/680' MSL.

Trees beginning abeam DER, 171' left of centerline, up to 80' AGL/680' MSL.

Trees beginning 500' from DER, crossing runway extended centerline, up to 80 AGL/660' MSL.

HELENA/WEST HELENA, AR

THOMPSON-ROBBINS (HEE)

TAKEOFF MINIMUMS AND (OBSTACLE) DEPARTURE PROCEDURES

AMDT 2 03NOV22 (22307) (FAA)

TAKEOFF MINIMUMS:

Rwy 9, 400-2½ or std. w/min. climb of 250' per NM to 800, or 1000-3 for VCOA.

DEPARTURE PROCEDURE:

Rwy 9, climb on heading 090° to 700 before turning right.

VCOA:

Rwy 9, obtain ATC approval for VCOA when requesting IFR clearance. Climb in visual conditions to cross Thompson-Robbins airport at or above 1000 before proceeding on course.

TAKEOFF OBSTACLE NOTES:

Rwy 9, trees beginning 5849' from DER, 1594' left of centerline, up to 416' MSL.

Trees beginning 1 NM from DER, 1379' left of centerline, up to 425' MSL.

Trees beginning 1 NM from DER, 1802' left of centerline, up to 430' MSL.

Trees beginning 1 NM from DER, 929' left of centerline, up to 441' MSL.

Trees beginning 1.1 NM from DER, 751' left of centerline, up to 450' MSL.

Trees beginning 1.1 NM from DER, 40' left of centerline, up to 451' MSL.

Tree 1.1 NM from DER, 543' right of centerline, 423' MSL.

Trees beginning 1.2 NM from DER, 337' left of centerline, up to 458' MSL.

Tree 1.2 NM from DER, 509' right of centerline, 444' MSL.

Tree 1.3 NM from DER, 132' right of centerline, 455' MSL.

Tree 1.3 NM from DER, 1371' left of centerline, 459' MSL.

Tree 1.3 NM from DER, 1884' left of centerline, 464' MSL.

Tree 1.3 NM from DER, 2330' left of centerline, 465' MSL.

Trees beginning 1.3 NM from DER, 1254' left of centerline, up to 470' MSL.

Antenna 2 NM from DER, 1878' right of centerline, 233' AGL/614' MSL.

Tower 2 NM from DER, 1823' right of centerline, 238' AGL/621' MSL.

CON'T

22 FEB 2024 to 21 MAR 2024

22 FEB 2024 to 21 MAR 2024

TAKEOFF MINIMUMS, (OBSTACLE) DEPARTURE PROCEDURES, AND DIVERSE VECTOR AREA (RADAR VECTORS)

23278

SC-1

TAKEOFF MINIMUMS, (OBSTACLE) DEPARTURE PROCEDURES, AND DIVERSE VECTOR AREA (RADAR VECTORS)

23278

HELENA/WEST HELENA, AR (CON'T)

THOMPSON-ROBBINS (HEE) (CON'T)

Rwy 18, lighting 9' from DER, 92' left of centerline, 2' AGL/239' MSL.
Lighting 11' from DER, 92' right of centerline, 4' AGL/240' MSL.
Sign 99' from DER, 359' left of centerline, 3' AGL/242' MSL.
Tree 1018' from DER, 547' left of centerline, 50' AGL/287' MSL.
Tree 1886' from DER, 809' right of centerline, 328' MSL.
Trees beginning 1953' from DER, 545' left of centerline, up to 84' AGL/299' MSL.
Trees beginning 2490' from DER, 942' left of centerline, up to 83' AGL/315' MSL.
Rwy 27, lighting 42' from DER, 63' left of centerline, 4' AGL/240' MSL.
Trees beginning 694' from DER, 135' left of centerline, up to 286' MSL.
Tree 3399' from DER, 234' right of centerline, 332' MSL.
Rwy 36, lighting 3' from DER, 92' right of centerline, 2' AGL/242' MSL.
Lighting 6' from DER, 93' left of centerline, 3' AGL/242' MSL.
Tree, terrain beginning 181' from DER, 490' right of centerline, up to 257' MSL.
Trees 208' from DER, 546' left of centerline, 46' AGL/282' MSL.
Trees beginning 218' from DER, 307' left of centerline, up to 309' MSL.
Trees beginning 234' from DER, 297' right of centerline, up to 307' MSL.
Trees beginning 1129' from DER, 598' right of centerline, up to 311' MSL.
Trees beginning 1633' from DER, 88' right of centerline, up to 318' MSL.
Tree 1920' from DER, 929' left of centerline, 312' MSL.
Trees beginning 1930' from DER, 26' left of centerline, up to 95' AGL/323' MSL.
Tree 2246' from DER, 1101' right of centerline, 89' AGL/331' MSL.
Trees beginning 2287' from DER, 1013' right of centerline, up to 334' MSL.
Trees beginning 2410' from DER, 80' left of centerline, up to 326' MSL.
Trees beginning 2485' from DER, 542' right of centerline, up to 342' MSL.
Trees beginning 2531' from DER, 181' right of centerline, up to 353' MSL.
Trees beginning 3146' from DER, 17' left of centerline, up to 331' MSL.

HENRY POST AAF (KFSI)

FORT SILL, OK

TAKEOFF MINIMUMS AND (OBSTACLE) DEPARTURE PROCEDURES

AMDT 2 05OCT23 (23278) (USA)

DEPARTURE PROCEDURE:

Rwy 36, climb hdg 356° to 2200 before turning left.

TAKEOFF OBSTACLE NOTES:

Rwy 18, tree 953' from DER, 669' right of centerline, 1198' MSL.
Pole 1140' from DER, 784' right of centerline, 43' AGL/1210' MSL.
Pole 1590' from DER, 860' right of centerline, 54' AGL/1226' MSL.
Tree 2153' from DER, 38' left of centerline, 1221' MSL.
Tree 2489' from DER, 295' right of centerline, 1229' MSL.
Pole 1587' from DER, 867' right of centerline, 1235' MSL.
Tree 2273' from DER, 1028' right of centerline, 1232' MSL.
Pole 1136' from DER, 787' right of centerline, 1210' MSL.
Pole 1346' from DER, 782' right of centerline, 1206' MSL.

HENRYETTA, OK

HENRYETTA MUNI (F10)

TAKEOFF MINIMUMS AND (OBSTACLE) DEPARTURE PROCEDURES

AMDT 3 29JUL10 (10210) (FAA)

TAKEOFF MINIMUMS:

Rwy 36, 500-3 or std. with a min. climb of 312' per NM to 1500.

DEPARTURE PROCEDURE:

Rwy 36, climb heading 356° to 1300 before proceeding on course.

TAKEOFF OBSTACLE NOTES:

Rwy 18, numerous trees beginning 778' from DER, 177' left of centerline, up to 100' AGL/939' MSL.
Numerous trees beginning 335' from DER, 22' right of centerline, up to 100' AGL/959' MSL.
Rwy 36, tower 13139' from DER, 885' right of centerline, 318' AGL/1273' MSL.
Tower 8882' from DER, 6059' left of centerline, 33' AGL/1223' MSL.

HINTON, OK

HINTON MUNI (2O8)

TAKEOFF MINIMUMS AND (OBSTACLE) DEPARTURE PROCEDURES

ORIG-A 17JUN21 (21168) (FAA)

TAKEOFF OBSTACLE NOTES:

Rwy 18, traverse way beginning 5' from DER, 227' left of centerline, up to 15' AGL/1599' MSL.
Pole, traverse way, trees beginning 500' from DER, 229' left of centerline, up to 1610' MSL.
Trees 854' from DER, 704' left of centerline, 1617' MSL.
Rwy 36, sign 22' from DER, 124' left of centerline, 1578' MSL.
Traverse way beginning 63' from DER, 227' right of centerline, up to 15' AGL/1587' MSL.

TAKEOFF MINIMUMS, (OBSTACLE) DEPARTURE PROCEDURES, AND DIVERSE VECTOR AREA (RADAR VECTORS)

23278

SC-1

TAKEOFF MINIMUMS, (OBSTACLE) DEPARTURE PROCEDURES, AND DIVERSE VECTOR AREA (RADAR VECTORS)

23278

HOBART, OK

HOBART RGNL (HBR)

TAKEOFF MINIMUMS AND (OBSTACLE) DEPARTURE PROCEDURES

AMDT 1A 08NOV18 (18312) (FAA)

TAKEOFF MINIMUMS:

Rwys 3, 21, NA - environmental.

TAKEOFF OBSTACLE NOTES:

Rwy 35, terrain beginning 107' from DER, 185' left of centerline, 0' AGL/1549' MSL.

Terrain beginning 109' from DER, 63' right of centerline, 0' AGL/1549' MSL.

HOLDENVILLE, OK

HOLDENVILLE MUNI (F99)

TAKEOFF MINIMUMS AND (OBSTACLE) DEPARTURE PROCEDURES

ORIG-A 10OCT19 (19283) (FAA)

DEPARTURE PROCEDURE:

Rwy 35, climb heading 354° to 1400 before turning right.

TAKEOFF OBSTACLE NOTES:

Rwy 17, trees beginning 120' from DER, 370' right of centerline, up to 871' MSL.

Trees and vehicles on road beginning 241' from DER, 426' right of centerline, up to 880' MSL.

Vegetation beginning 275' from DER, 255' left of centerline, up to 867' MSL.

Train on tracks 628' from DER, left and right of extended runway centerline, up to 23' AGL/882' MSL.

Vehicles on road beginning 640' from DER, left to right of extended runway centerline, up to 881' MSL.

Poles and power lines beginning 716' from DER, left to right of extended runway centerline, up to 34' AGL/889' MSL.

Trees and elevator beginning 727' from DER, 666' right of centerline, up to 903' MSL.

Poles and trees beginning 750' from DER, 522' left of centerline, up to 32' AGL/890' MSL.

Rwy 35, vegetation 195' from DER, 265' left of centerline, up to 871' MSL.

Pole 277' from DER, 543' right of centerline, 20' AGL/877' MSL.

Trees beginning 597' from DER, 520' right of centerline, up to 898' MSL.

Trees beginning 1214' from DER, 753' left of centerline, up to 909' MSL.

Trees beginning 1605' from DER, 525' right of centerline, up to 901' MSL.

HOLLIS, OK

HOLLIS MUNI (O35)

TAKEOFF MINIMUMS AND (OBSTACLE) DEPARTURE PROCEDURES

ORIG 19JUL18 (18200) (FAA)

DEPARTURE PROCEDURE:

Rwy 18, climb heading 175° to 2200 before proceeding on course.

TAKEOFF OBSTACLE NOTES:

Rwy 18, terrain beginning 0' from DER, 7' right of centerline, up to 1660' MSL.

Fence beginning 4' from DER, 253' left of centerline, up to 5' AGL/1658' MSL.

Trees beginning 89' from DER, 254' left of centerline, up to 7' AGL/1659' MSL.

Pole beginning 989' from DER, 590' right of centerline, up to 53' AGL/1706' MSL.

Tower 4194' from DER, 1305' right of centerline, 130' AGL/1759' MSL.

Rwy 36, fence 0' from DER, 249' right of centerline, 6' AGL/1658' MSL.

Vehicles on road beginning 478' from DER, 152' left of centerline, up to 1672' MSL.

Vehicles on road beginning 482' from DER, 6' right of centerline, up to 1670' MSL.

HOPE, AR

HOPE MUNI (M18)

TAKEOFF MINIMUMS AND (OBSTACLE) DEPARTURE PROCEDURES

AMDT 1 13NOV14 (14317) (FAA)

TAKEOFF OBSTACLE NOTES:

Rwy 4, trees beginning 1776' from DER, 422' left of centerline, up to 100' AGL/469' MSL.

Trees and poles beginning 1930' from DER, 99' right of centerline, up to 100' AGL/469' MSL.

Pole 2256' from DER, 24' right of centerline, 65' AGL/434' MSL.

Trees and poles beginning 2345' from DER, 152' left of centerline, up to 100' AGL/489' MSL.

Rwy 22, trees beginning abeam DER, 500' right of centerline, up to 100' AGL/439' MSL.

Tree 117' from DER, 211' right of centerline, 100' AGL/429' MSL.

Trees beginning 164' from DER, 10' right of centerline, up to 100' AGL/429' MSL.

Trees beginning 51' from DER, 211' left of centerline, up to 100' AGL/429' MSL.

Trees beginning 325' from DER, 45' left of centerline, up to 100' AGL/429' MSL.

Rwy 16, trees beginning 1066' from DER, 722' right of centerline, up to 100' AGL/439' MSL.

Trees beginning 1427' from DER, 843' left of centerline, up to 100' AGL/439' MSL.

Rwy 34, bush 39' from DER, 162' left of centerline, 10' AGL/369' MSL.

Fence 154' from DER, 474' right of centerline, 11' AGL/371' MSL.

Tree 565' from DER, 609' left of centerline, 100' AGL/479' MSL.

Trees beginning 897' from DER, 708' left of centerline, up to 100' AGL/479' MSL.

Tree 1002' from DER, 748' right of centerline, 100' AGL/479' MSL.

Trees beginning 1023' from DER, 513' right of centerline, up to 100' AGL/479' MSL.

TAKEOFF MINIMUMS, (OBSTACLE) DEPARTURE PROCEDURES, AND DIVERSE VECTOR AREA (RADAR VECTORS)

23278

SC-1

TAKEOFF MINIMUMS, (OBSTACLE) DEPARTURE PROCEDURES, AND DIVERSE VECTOR AREA (RADAR VECTORS)

23278

HORSEHOE BEND, AR

HORSEHOE BEND (6M2)

TAKEOFF MINIMUMS AND (OBSTACLE) DEPARTURE PROCEDURES

ORIG 05JAN17 (17005) (FAA)

TAKEOFF MINIMUMS:

Rwy 13, 300-1¼.

Rwy 31, 300-1.

TAKEOFF OBSTACLE NOTES:

Rwy 13, trees beginning 12' from DER, 264' right of centerline, up to 125' AGL/884' MSL.

Trees beginning 15' from DER, 73' left of centerline, up to 125' AGL/944' MSL.

Rwy 31, trees beginning 10' from DER, 213' left of centerline, up to 125' AGL/924' MSL.

Vehicles on road beginning 17' from DER, 277' left of centerline crossing extended runway centerline, up to 15' AGL/894' MSL.

Trees beginning 331' from DER, 193' left of centerline, up to 125' AGL/944' MSL.

Trees beginning 447' from DER, 291' right of centerline, up to 125' AGL/944' MSL.

Trees beginning 644' from DER, 141' left of centerline, up to 125' AGL/964' MSL.

Trees beginning 699' from DER, 310' right of centerline, up to 125' AGL/964' MSL.

Trees beginning 802' from DER, 607' right of centerline, up to 125' AGL/984' MSL.

Trees beginning 969' from DER, 51' right of centerline, up to 125' AGL/1004' MSL.

Trees beginning 1001' from DER, 188' left of centerline, up to 125' AGL/984' MSL.

Trees beginning 1359' from DER, 437' right of centerline, up to 125' AGL/1024' MSL.

HOT SPRINGS, AR

MEML FLD (HOT)

TAKEOFF MINIMUMS AND (OBSTACLE) DEPARTURE PROCEDURES

AMDT 7 15AUG19 (22139) (FAA)

TAKEOFF MINIMUMS:

Rwy 5, 600-2½ or std. w/min. climb of 382' per NM to 1300 or 1600-3 for VCOA.

Rwy 13, 300-2¼ or std. w/min. climb of 210' per NM to 900 or alternately, with std. takeoff minimums and normal 200' per NM climb gradient, takeoff must occur no later than 1500' prior to DER.

Rwy 31, 400-1¾ or std. w/min. climb of 433' per NM to 1100.

DEPARTURE PROCEDURE:

Rwy 5, climb on heading 053° to 2000 before turning westbound.

Rwy 13, climb on heading 133° to 1700 before proceeding on course.

Rwy 23, climb on heading 233° to 1500 before proceeding on course.

Rwy 31, climb on heading 313° to 1800 before turning right.

TAKEOFF OBSTACLE NOTES:

Rwy 5, tree, vegetation and rising terrain beginning 2' from DER, 452' right of centerline, up to 550' MSL.

Tree 646' from DER, 565' right of centerline, 590' MSL.

Trees beginning 671' from DER, 507' right of centerline, up to 592' MSL.

Trees beginning 1041' from DER, 671' left of centerline, up to 59' AGL/626' MSL.

Trees beginning 1227' from DER, 485' right of centerline, up to 595' MSL.

Tree and NAVAID beginning 1554' from DER, 300' left of centerline, up to 641' MSL.

Trees, pole and spire beginning 1886' from DER, 68' left of centerline, up to 654' MSL.

Tree 3500' from DER, 550' right of centerline, 654' MSL.

Tree and tower beginning 3537' from DER, 715' right of centerline, up to 79' AGL/661' MSL.

Tree 4466' from DER, 734' left of centerline, 687' MSL.

Tower and tree beginning 1.1 NM from DER, 1110' left of centerline, up to 92' AGL/24' MSL.

Trees beginning 1.9 NM DER, 3374' left of centerline, up to 62' AGL/1096' MSL.

Rwy 13, traverse way 84' from DER, 437' right of centerline, 512' MSL.

Tree 166' from DER, 524' right of centerline, 49' AGL/534' MSL.

Tree 177' from DER, 350' right of centerline, 45' AGL/542' MSL.

Trees beginning 220' from DER, 307' right of centerline, up to 53' AGL/545' MSL.

Trees beginning 264' from DER, 474' left of centerline, up to 68' AGL/573' MSL.

Trees beginning 317' from DER, 94' left of centerline, up to 574' MSL.

Trees beginning 434' from DER, 7' right of centerline, up to 63' AGL/546' MSL.

Trees beginning 1749' from DER, 70' right of centerline, up to 84' AGL/588' MSL.

Trees beginning 2128' from DER, 48' left of centerline, up to 85' AGL/579' MSL.

Tree 2547' from DER, 809' left of centerline, 74' AGL/587' MSL.

Trees beginning 2611' from DER, 544' right of centerline, up to 79' AGL/601' MSL.

Tree 2664' from DER, 1013' left of centerline, 77' AGL/591' MSL.

Tree 2780' from DER, 731' right of centerline, 75' AGL/603' MSL.

Tree 2902' from DER, 1188' left of centerline, 79' AGL/606' MSL.

Tree and pole beginning 3043' from DER, 17' right of centerline, up to 66' AGL/616' MSL.

Tree 3063' from DER, 53' left of centerline, 71' AGL/622' MSL.

Tree and pole beginning 3175' from DER, 77' left of centerline, up to 80' AGL/630' MSL.

Poles beginning 3228' from DER, 261' left of centerline, up to 71' AGL/631' MSL.

Trees beginning 3296' from DER, 36' right of centerline, up to 76' AGL/624' MSL.

Tree 3450' from DER, 511' left of centerline, 71' AGL/636' MSL.

Tower 1.8 NM from DER, 2044' left of centerline, 355' AGL/802' MSL.

Antenna 1.8 NM from DER, 2088' left of centerline, 319' AGL/804' MSL.

Rwy 23, tree 22' from DER, 314' left of centerline, 29' AGL/510' MSL.

Tree 606' from DER, 636' right of centerline, 546' MSL.

CONT

22 FEB 2024 to 21 MAR 2024

22 FEB 2024 to 21 MAR 2024

TAKEOFF MINIMUMS, (OBSTACLE) DEPARTURE PROCEDURES, AND DIVERSE VECTOR AREA (RADAR VECTORS)

23278

SC-1

TAKEOFF MINIMUMS, (OBSTACLE) DEPARTURE PROCEDURES, AND DIVERSE VECTOR AREA (RADAR VECTORS)

23278

HOT SPRINGS, AR (CON'T)

MEML FLD (HOT) (CON'T)

Rwy 31, trees beginning 12' from DER, 136' left of centerline, up to 73' AGL/564' MSL.
Trees and pole beginning 330' from DER, 113' left of centerline, up to 75' AGL/577' MSL.
Traverse way 451' from DER, 13' right of centerline, 534' MSL.
Trees beginning 472' from DER, 111' right of centerline, up to 52' AGL/575' MSL.
Trees and pole beginning 671' from DER, 137' left of centerline, up to 66' AGL/580' MSL.
Trees beginning 888' from DER, 71' right of centerline, up to 82' AGL/581' MSL.
Trees beginning 1002' from DER, 136' right of centerline, up to 73' AGL/585' MSL.
Trees beginning 1017' from DER, 155' left of centerline, up to 68' AGL/588' MSL.
Tree 1488' from DER, 736' left of centerline, 58' AGL/592' MSL.
Tree 2975' from DER, 764' left of centerline, 65' AGL/610' MSL.
Tree 3109' from DER, 439' left of centerline, 69' AGL/614' MSL.
Trees beginning 3193' from DER, 68' right of centerline, up to 69' AGL/639' MSL.
Tree 3752' from DER, 320' left of centerline, 83' AGL/646' MSL.
Tree 4785' from DER, 1740' right of centerline, 88' AGL/669' MSL.
Tree 5806' from DER, 1427' right of centerline, 61' AGL/677' MSL.
Building 1 NM from DER, 1897' right of centerline, 53' AGL/724' MSL.
Traverse way and building beginning 1.1 NM from DER, 1503' right of centerline, up to 886' MSL.

HUGO, OK

STAN STAMPER MUNI (HHW)

TAKEOFF MINIMUMS AND (OBSTACLE) DEPARTURE PROCEDURES

ORIG 20OCT11 (11293) (FAA)

TAKEOFF OBSTACLE NOTES:

Rwy 17, trees beginning 686' from DER, 32' right of centerline, up to 100' AGL/660' MSL.
Rwy 35, trees beginning 411' from DER, 264' left of centerline, up to 100' AGL/665' MSL.
Trees beginning 1507' from DER, 61' right of centerline, up to 100' AGL/662' MSL.

HUNTSVILLE, AR

HUNTSVILLE MUNI (H34)

TAKEOFF MINIMUMS AND (OBSTACLE) DEPARTURE PROCEDURES

ORIG-A 16JUN22 (22167) (FAA)

TAKEOFF MINIMUMS:

Rwys 3, 21, NA-Environmental.

TAKEOFF OBSTACLE NOTES:

Rwy 12, pole 46' from DER, 408' left of centerline, 45' AGL/1759' MSL.
Pole 175' from DER, 504' left of centerline, 47' AGL/1756' MSL.
Tree 2685' from DER, 841' right of centerline, 80' AGL/1822' MSL.
Tree 3201' from DER, 726' right of centerline, 100' AGL/1866' MSL.
Rwy 30, tree 20' from DER, 362' right of centerline, 61' AGL/1764' MSL.

IDABEL, OK

MC CURTAIN COUNTY RGNL(404)

TAKEOFF MINIMUMS AND (OBSTACLE) DEPARTURE PROCEDURES

ORIG 23JAN03 (03023) (FAA)

TAKEOFF OBSTACLE NOTES:

Rwy 2, trees 1.92 NM from DER, on centerline, 100' AGL/629' MSL.

JONESBORO, AR

JONESBORO MUNI (JBR)

TAKEOFF MINIMUMS AND (OBSTACLE) DEPARTURE PROCEDURES

AMDT 3 07MAR13 (13066) (FAA)

TAKEOFF MINIMUMS:

Rwy 31, NA-obstacles.

TAKEOFF OBSTACLE NOTES:

Rwy 13, trees beginning 356' from DER, 188' right of centerline, up to 75' AGL/304' MSL.
Pole 1214' from DER, 341' right of centerline, 40' AGL/291' MSL.
Railroad, trees, and pole beginning 600' from DER, 10' left of centerline, up to 75' AGL/302' MSL.
Rwy 23, trees beginning 2600' from DER, 457' right centerline, up to 75' AGL/343' MSL.
Trees beginning 1588' from DER, 721' left of centerline, up to 75' AGL/339' MSL.
Rwy 5, trees beginning 873' from DER, 458' right of centerline, up to 75' AGL/304' MSL.
Trees beginning 1226' from DER, 558' left of centerline, up to 75' AGL/315' MSL.

22 FEB 2024 to 21 MAR 2024

22 FEB 2024 to 21 MAR 2024

TAKEOFF MINIMUMS, (OBSTACLE) DEPARTURE PROCEDURES, AND DIVERSE VECTOR AREA (RADAR VECTORS)

23278

SC-1



TAKEOFF MINIMUMS, (OBSTACLE) DEPARTURE PROCEDURES, AND



23278

DIVERSE VECTOR AREA (RADAR VECTORS)

KETCHUM, OK

SOUTH GRAND LAKE RGNL (1K8)

TAKEOFF MINIMUMS AND (OBSTACLE) DEPARTURE PROCEDURES

ORIG 21JUL16 (16203) (FAA)

TAKEOFF MINIMUMS:

Rwy 36, 300-1¼ or std. w/min. climb of 453' per NM to 1200.

DEPARTURE PROCEDURE:

Rwy 18, climb on heading 178° to 1400 before turning left.**Rwy 36**, climb on heading 358° to 1400 before turning left.

TAKEOFF OBSTACLE NOTES:

Rwy 18, tree, bush beginning 58' from DER, 42' right of centerline, up to 789' MSL.

Vehicles on road beginning 274' from DER, 199' right of centerline, up to 796' MSL.

Vehicles on road beginning 275' from DER, 13' right of centerline, up to 797' MSL.

Pole 294' from DER, 125' right of centerline, 21' AGL/803' MSL.

Pole 300' from DER, 442' right of centerline, 813' MSL.

Tree, pole beginning 410' from DER, 22' right of centerline, up to 820' MSL.

Tree 1416' from DER, 717' right of centerline, 823' MSL.

Tree 1429' from DER, 541' right of centerline, 827' MSL.

Trees beginning 1477' from DER, 8' right of centerline, up to 60' AGL/829' MSL.

Trees beginning 1710' from DER, 15' right of centerline, up to 60' AGL/830' MSL.

Tree 2972' from DER, 839' right of centerline, 859' MSL.

Tree, vehicles on road, pole, post beginning 75' from DER, 10' left of centerline, up to 44' AGL/824' MSL.

Trees beginning 792' from DER, 544' left of centerline, up to 828' MSL.

Tree 1052' from DER, 634' left of centerline, 835' MSL.

Trees beginning 1089' from DER, 137' left of centerline, up to 840' MSL.

Trees beginning 1405' from DER, 54' left of centerline, up to 842' MSL.

Trees beginning 1500' from DER, 62' left of centerline, up to 844' MSL.

Trees beginning 1600' from DER, 16' left of centerline, up to 846' MSL.

Trees beginning 1734' from DER, 87' left of centerline, up to 853' MSL.

Tree 2282' from DER, 981' left of centerline, 855' MSL.

Tree 2309' from DER, 1108' left of centerline, 858' MSL.

Rwy 36, tree, terrain beginning 4728' from DER, on centerline, up to 39' AGL/985' MSL.

Bush 28' from DER, 82' right of centerline, 8' AGL/787' MSL.

Tree 55' from DER, 290' right of centerline, 795' MSL.

Tree, vehicles on road beginning 185' from DER, 27' right of centerline, up to 798' MSL.

Tree 292' from DER, 297' right of centerline, 816' MSL.

Trees beginning 293' from DER, 33' right of centerline, up to 818' MSL.

Trees beginning 629' from DER, 31' right of centerline, up to 36' AGL/820' MSL.

Tree 741' from DER, 145' right of centerline, 41' AGL/827' MSL.

Trees beginning 785' from DER, 2' right of centerline, up to 43' AGL/829' MSL.

Tree 1413' from DER, 525' right of centerline, 836' MSL.

Trees beginning 1529' from DER, 425' right of centerline, up to 845' MSL.

Tree 2457' from DER, 1093' right of centerline, 856' MSL.

Trees beginning 2612' from DER, 8' right of centerline, up to 861' MSL.

Trees beginning 2897' from DER, 60' right of centerline, up to 862' MSL.

Tree 2990' from DER, 387' right of centerline, 55' AGL/872' MSL.

Tree 3031' from DER, 260' right of centerline, 57' AGL/879' MSL.

Trees beginning 3127' from DER, 113' right of centerline, up to 71' AGL/892' MSL.

Trees beginning 3427' from DER, 9' right of centerline, up to 64' AGL/897' MSL.

Tree 3843' from DER, 170' right of centerline, 40' AGL/899' MSL.

Trees beginning 3846' from DER, 56' right of centerline, up to 59' AGL/912' MSL.

Trees beginning 3932' from DER, 18' right of centerline, up to 50' AGL/913' MSL.

Trees beginning 4065' from DER, 144' right of centerline, up to 49' AGL/918' MSL.

Trees beginning 4072' from DER, 26' right of centerline, up to 47' AGL/920' MSL.

Trees beginning 4144' from DER, 19' right of centerline, up to 62' AGL/929' MSL.

Tree, bush beginning 4223' from DER, 69' right of centerline, up to 63' AGL/943' MSL.

Tree, bush, terrain beginning 4422' from DER, 36' right of centerline, up to 56' AGL/945' MSL.

Tree, bush, terrain beginning 4619' from DER, 51' right of centerline, up to 58' AGL/968' MSL.

Tree 4709' from DER, 344' right of centerline, 58' AGL/977' MSL.

CON'T

22 FEB 2024 to 21 MAR 2024

22 FEB 2024 to 21 MAR 2024



TAKEOFF MINIMUMS, (OBSTACLE) DEPARTURE PROCEDURES, AND



23278

DIVERSE VECTOR AREA (RADAR VECTORS)

TAKEOFF MINIMUMS, (OBSTACLE) DEPARTURE PROCEDURES, AND DIVERSE VECTOR AREA (RADAR VECTORS)

23278

KETCHUM, OK (CON'T)

SOUTH GRAND LAKE RGNL (1K8) (CON'T)

Rwy 36 (CON'T), trees beginning 4833' from DER, 99' right of centerline, up to 44' AGL/998' MSL.

Trees beginning 4902' from DER, 229' right of centerline, up to 63' AGL/1009' MSL.

Tree, terrain beginning 4933' from DER, 26' right of centerline, up to 57' AGL/1013' MSL.

Trees beginning 4982' from DER, 97' right of centerline, up to 39' AGL/1019' MSL.

Tree, bush, terrain beginning 5020' from DER, 64' right of centerline, up to 40' AGL/1020' MSL.

Tree, terrain, bush beginning 5223' from DER, 4' right of centerline, up to 51' AGL/1026' MSL.

Tree 1 NM from DER, 1132' right of centerline, 947' MSL.

Tree, bush beginning 2' from DER, 122' left of centerline, up to 800' MSL.

Tree, terrain, bush, fence, vehicles on road beginning 109' from DER, 3' left of centerline, up to 36' AGL/833' MSL.

Tree, terrain, driveway beginning 388' from DER, 2' left of centerline, up to 845' MSL.

Trees beginning 1490' from DER, 41' left of centerline, up to 48' AGL/846' MSL.

Trees beginning 1582' from DER, 13' left of centerline, up to 47' AGL/848' MSL.

Tree 1640' from DER, 65' left of centerline, 48' AGL/849' MSL.

Tree 1699' from DER, 131' left of centerline, 47' AGL/851' MSL.

Tree, terrain beginning 1704' from DER, 25' left of centerline, up to 45' AGL/857' MSL.

Tree, pole, terrain beginning 1881' from DER, 83' left of centerline, up to 44' AGL/859' MSL.

Tree, terrain beginning 1986' from DER, 103' left of centerline, up to 56' AGL/866' MSL.

Trees beginning 2210' from DER, 175' left of centerline, up to 56' AGL/868' MSL.

Trees beginning 2379' from DER, 220' left of centerline, up to 53' AGL/870' MSL.

Tree, pole beginning 2477' from DER, 304' left of centerline, up to 876' MSL.

Trees beginning 2641' from DER, 366' left of centerline, up to 58' AGL/884' MSL.

Tree, pole beginning 2709' from DER, 112' left of centerline, up to 891' MSL.

Trees beginning 2931' from DER, 35' left of centerline, up to 928' MSL.

Trees beginning 3043' from DER, 163' left of centerline, up to 929' MSL.

Trees beginning 3213' from DER, 286' left of centerline, up to 942' MSL.

Tree, pole beginning 3329' from DER, 168' left of centerline, up to 958' MSL.

Tree 3426' from DER, 1210' left of centerline, 965' MSL.

Trees beginning 3427' from DER, 154' left of centerline, up to 969' MSL.

Trees beginning 3533' from DER, 66' left of centerline, up to 988' MSL.

Trees beginning 3680' from DER, 12' left of centerline, up to 997' MSL.

Tree, bush beginning 4265' from DER, 47' left of centerline, up to 998' MSL.

Tree, bush beginning 4325' from DER, 267' left of centerline, up to 1008' MSL.

Tree, bush beginning 4351' from DER, 95' left of centerline, up to 1013' MSL.

Tree, bush beginning 4393' from DER, 30' left of centerline, up to 1017' MSL.

Trees beginning 4466' from DER, 376' left of centerline, up to 1024' MSL.

Tree, terrain, bush beginning 4485' from DER, 50' left of centerline, up to 1022' MSL.

Tree, bush, terrain beginning 4602' from DER, 11' left of centerline, up to 1025' MSL.

Tree, terrain beginning 4682' from DER, 84' left of centerline, up to 1030' MSL.

Tree, terrain beginning 4797' from DER, 143' left of centerline, up to 1032' MSL.

Tree, terrain, bush, trnsn towers beginning 4880' from DER, 4' left of centerline, up to 1033' MSL.

LAKE VILLAGE, AR

LAKE VILLAGE MUNI (M32)

TAKEOFF MINIMUMS AND (OBSTACLE) DEPARTURE PROCEDURES

AMDT1 02MAR17 (17061) (FAA)

TAKEOFF OBSTACLE NOTES:

Rwy 1, tree 18' from DER, 187' left of centerline, 15' AGL/141' MSL.

Rising terrain 18' from DER, 47' right of centerline, 126' MSL.

Trees, beginning 125' from DER, 159' left of centerline, up to 79' AGL/204' MSL.

Trees, beginning 1010' from DER, 387' right of centerline, up to 66' AGL/192' MSL.

Rwy 19, rising terrain 14' from DER, 221' left of centerline, 127' MSL.

Bush 24' from DER, 194' right of centerline, 6' AGL/131' MSL.

Catenary, bush, and vehicles on road beginning 96' from DER, left and right of centerline, up to 29' AGL/154' MSL.

Poles, buildings, antenna, and vehicles on road beginning 216' from DER, 191' left of centerline, up to 33' AGL/157' MSL.

Trees beginning 691' from DER, 221' right of centerline, 58' AGL/179' MSL.

Tree and poles beginning 961' from DER, left and right of centerline, up to 65' AGL/183' MSL.

Trees, antenna, and pole beginning 1055' from DER, left and right of centerline, up to 72' AGL/186' MSL.

Trees beginning 1405' from DER, 212' right of centerline, up to 69' AGL/189' MSL.

Trees and antenna beginning 1636' from DER, left and right of centerline, up to 74' AGL/199' MSL.

Trees beginning 1714' from DER, left and right of centerline, up to 82' AGL/207' MSL.

Trees beginning 2210' from DER, left and right of centerline, up to 91' AGL/212' MSL.

LAWTON, OK

LAWTON-FT SILL RGNL (LAW)

TAKEOFF MINIMUMS AND (OBSTACLE) DEPARTURE PROCEDURES

ORIG 11FEB10 (10042) (FAA)

TAKEOFF OBSTACLE NOTES:

Rwy 17, tree 1709' from DER, 870' left of centerline, 60' AGL/1119' MSL.

Tree 918' from DER, 733' right of centerline, 31' AGL/1098' MSL.

Rwy 35, tree 2377' from DER, 802' left of centerline, 60' AGL/1179' MSL.

TAKEOFF MINIMUMS, (OBSTACLE) DEPARTURE PROCEDURES, AND DIVERSE VECTOR AREA (RADAR VECTORS)

23278

SC-1

TAKEOFF MINIMUMS, (OBSTACLE) DEPARTURE PROCEDURES, AND DIVERSE VECTOR AREA (RADAR VECTORS)

23278

LITTLE ROCK, AR

BILL AND HILLARY CLINTON NTL/ADAMS FLD (LIT)

TAKEOFF MINIMUMS AND (OBSTACLE) DEPARTURE PROCEDURES

AMDT 10 24MAR22 (22083) (FAA)

TAKEOFF MINIMUMS:

Rwy 18, 300-1½ or std. w/min. climb of 420' per NM to 500.

Rwy 22L, 300-1½ or std. w/min. climb of 240' per NM to 500.

Rwy 22R, 300-2 or std. w/min. climb of 395' per NM to 500.

DEPARTURE PROCEDURE:

Rwy 22R, climb on heading 227° to 1100 before turning right.

Rwy 36, climb on heading 002° to 800 before turning left.

TAKEOFF OBSTACLE NOTES:

Rwy 4L, lighting 10' from DER, on centerline, 1' AGL/263' MSL.

Trees beginning 1155' from DER, 729' right of centerline, up to 312' MSL.

Trees beginning 1729' from DER, 737' right of centerline, up to 322' MSL.

Trees beginning 1971' from DER, 948' right of centerline, up to 324' MSL.

Rwy 4R, lighting 8' from DER, on centerline, 260' MSL.

Tree 663' from DER, 645' right of centerline, 294' MSL.

Trees beginning 815' from DER, 494' right of centerline, up to 295' MSL.

Tree 3170' from DER, 646' left of centerline, 342' MSL.

Tree 3295' from DER, 714' left of centerline, 345' MSL.

Tree 3481' from DER, 744' left of centerline, 351' MSL.

Tree 3499' from DER, 1347' left of centerline, 359' MSL.

Rwy 18, vehicles on road 59' from DER, 431' right of centerline, 267' MSL.

Vehicles on road, fence, lighting beginning 97' from DER, 23' right of centerline, up to 269' MSL.

Lighting 124' from DER, 124' left of centerline, 5' AGL/258' MSL.

General utility 475' from DER, 564' right of centerline, 19' AGL/271' MSL.

Fence, vehicles on road, lighting, pole beginning 488' from DER, 287' right of centerline, up to 32' AGL/282' MSL.

TREE, pole beginning 1023' from DER, 376' left of centerline, up to 299' MSL.

Tree, pole, vehicles on road beginning 1118' from DER, 32' right of centerline, up to 34' AGL/286' MSL.

Tree, vehicles on road, pole beginning 1183' from DER, 1' left of centerline, up to 303' MSL.

Trees beginning 1303' from DER, 10' left of centerline, up to 309' MSL.

Tree 1446' from DER, 15' right of centerline, 53' AGL/294' MSL.

Trees beginning 1466' from DER, 17' right of centerline, up to 75' AGL/315' MSL.

Tree, vehicles on road beginning 1789' from DER, 2' left of centerline, up to 328' MSL.

Tree 1853' from DER, 518' right of centerline, 317' MSL.

Tree, vehicles on road beginning 1863' from DER, on centerline, up to 322' MSL.

Trees beginning 2163' from DER, 52' right of centerline, up to 71' AGL/327' MSL.

Pole, tree beginning 2175' from DER, 8' left of centerline, up to 359' MSL.

Tree 2213' from DER, 273' right of centerline, 76' AGL/329' MSL.

Trees beginning 2218' from DER, 159' right of centerline, up to 331' MSL.

Trees beginning 2230' from DER, 161' right of centerline, up to 78' AGL/332' MSL.

Trees beginning 2252' from DER, 3' right of centerline, up to 78' AGL/333' MSL.

Trees beginning 2279' from DER, 11' right of centerline, up to 87' AGL/341' MSL.

Trees beginning 2339' from DER, 13' left of centerline, up to 93' AGL/363' MSL.

Tree 2343' from DER, 8' right of centerline, 71' AGL/344' MSL.

Trees beginning 2347' from DER, 9' right of centerline, up to 353' MSL.

Trees beginning 2383' from DER, 9' left of centerline, up to 90' AGL/364' MSL.

Tree, pole beginning 2429' from DER, on centerline, up to 91' AGL/369' MSL.

Trees beginning 2468' from DER, 10' right of centerline, up to 82' AGL/360' MSL.

Trees beginning 2492' from DER, 4' right of centerline, up to 89' AGL/368' MSL.

Trees beginning 2667' from DER, 13' left of centerline, up to 378' MSL.

Trees beginning 2730' from DER, 18' left of centerline, up to 77' AGL/379' MSL.

Trees beginning 2752' from DER, 27' right of centerline, up to 78' AGL/370' MSL.

Trees beginning 2777' from DER, 6' right of centerline, up to 81' AGL/374' MSL.

Trees beginning 2783' from DER, 6' right of centerline, up to 83' AGL/377' MSL.

Tree, vegetation, vehicles on road beginning 2816' from DER, 6' left of centerline, up to 78' AGL/383' MSL.

Trees beginning 2962' from DER, 14' right of centerline, up to 378' MSL.

Trees beginning 3023' from DER, 4' right of centerline, up to 68' AGL/382' MSL.

Trees beginning 3046' from DER, 39' right of centerline, up to 67' AGL/384' MSL.

Trees beginning 3049' from DER, 14' right of centerline, up to 72' AGL/388' MSL.

Trees beginning 3083' from DER, 15' right of centerline, up to 75' AGL/396' MSL.

Tree, vehicles on road beginning 3090' from DER, 8' left of centerline, up to 389' MSL.

Tree, vehicles on road beginning 3107' from DER, 3' left of centerline, up to 397' MSL.

Trees beginning 3115' from DER, 56' right of centerline, up to 400' MSL.

Tree, vehicles on road beginning 3121' from DER, on centerline, up to 69' AGL/404' MSL.

Tree, vehicles on road beginning 3162' from DER, 16' right of centerline, up to 413' MSL.

Tree, vegetation beginning 3194' from DER, 1' left of centerline, up to 406' MSL.

Tree, vehicles on road, terrain, vegetation beginning 3230' from DER, 4' right of centerline, up to 72' AGL/421' MSL.

Tree, vegetation beginning 3450' from DER, 6' left of centerline, up to 413' MSL.

Tree, vegetation, terrain beginning 3517' from DER, 9' right of centerline, up to 423' MSL.

Tree, vegetation beginning 3631' from DER, 33' right of centerline, up to 424' MSL.

Tree, vegetation beginning 3658' from DER, 15' right of centerline, up to 426' MSL.

Trees beginning 3796' from DER, 3' left of centerline, up to 37' AGL/414' MSL.

Trees beginning 3799' from DER, 59' right of centerline, up to 428' MSL.

CON'T

TAKEOFF MINIMUMS, (OBSTACLE) DEPARTURE PROCEDURES, AND DIVERSE VECTOR AREA (RADAR VECTORS)

23278

SC-1



TAKEOFF MINIMUMS, (OBSTACLE) DEPARTURE PROCEDURES, AND DIVERSE VECTOR AREA (RADAR VECTORS)



23278

LITTLE ROCK, AR (CON'T)

BILL AND HILLARY CLINTON NTL/ADAMS FLD (LIT) (CON'T)

Rwy 18 (CON'T), trees beginning 3807' from DER, 18' right of centerline, up to 62' AGL/435' MSL.
 Trees beginning 3814' from DER, 55' left of centerline, up to 49' AGL/416' MSL.
 Tree, vegetation, building beginning 3826' from DER, 2' left of centerline, up to 43' AGL/417' MSL.
 Trees beginning 3830' from DER, 62' right of centerline, up to 61' AGL/438' MSL.
 Trees beginning 3833' from DER, 11' right of centerline, up to 61' AGL/439' MSL.
 Trees beginning 3892' from DER, 7' right of centerline, up to 59' AGL/440' MSL.
 Tree, vehicles on road beginning 3946' from DER, 1' right of centerline, up to 59' AGL/444' MSL.
 Tree, vegetation, pole, catenary, elevator beginning 4115' from DER, on centerline, up to 81' AGL/451' MSL.
 Tree, building, tank, stack, pole beginning 4680' from DER, 11' right of centerline, up to 59' AGL/460' MSL.
 Trees beginning 1 NM from DER, 1021' left of centerline, up to 418' MSL.
 Tree 1 NM from DER, 1157' left of centerline, 420' MSL.
 Tree 1 NM from DER, 586' left of centerline, 426' MSL.
 Trees beginning 1 nm from DER, 298' left of centerline, up to 431' MSL.
 Trees beginning 1 NM from DER, 160' left of centerline, up to 78' AGL/435' MSL.
 Tree, pole beginning 1.1 NM from DER, 1557' right of centerline, up to 464' MSL.
 Trees beginning 1.2 NM from DER, 2205' right of centerline, up to 58' AGL/465' MSL.
 Trees beginning 1.2 NM from DER, 2302' right of centerline, up to 460' MSL.
Rwy 22L, vehicles on road 10' from DER, 389' left of centerline, 275' MSL.
 Vehicles on road, fence beginning 111' from DER, 32' left of centerline, up to 277' MSL.
 Tree 564' from DER, 648' left of centerline, 307' MSL.
 Tree, pole, vehicles on road beginning 607' from DER, 29' left of centerline, up to 318' MSL.
 Pole 718' from DER, 629' right of centerline, 285' MSL.
 Tree, pole beginning 966' from DER, 38' left of centerline, up to 72' AGL/325' MSL.
 Pole 979' from DER, 502' right of centerline, 36' AGL/295' MSL.
 Trees beginning 989' from DER, 25' right of centerline, up to 49' AGL/296' MSL.
 Tree 1010' from DER, 52' right of centerline, 46' AGL/297' MSL.
 Tree, vehicles on road beginning 1023' from DER, 62' right of centerline, up to 51' AGL/300' MSL.
 Vehicles on road beginning 1319' from DER, 114' right of centerline, up to 51' AGL/301' MSL.
 Vehicles on road 1440' from DER, 153' right of centerline, 52' AGL/303' MSL.
 Trees beginning 1550' from DER, 469' left of centerline, up to 331' MSL.
 Tree 1558' from DER, 516' right of centerline, 311' MSL.
 Tree, sign, tower, pole beginning 1622' from DER, 100' left of centerline, up to 345' MSL.
 Tree, pole beginning 2067' from DER, 19' left of centerline, up to 367' MSL.
 Pole 2142' from DER, 1049' right of centerline, 320' MSL.
 Trees beginning 2280' from DER, 197' left of centerline, up to 379' MSL.
 Tree, pole beginning 2466' from DER, 42' left of centerline, up to 382' MSL.
 Trees beginning 4646' from DER, 1615' right of centerline, up to 386' MSL.
 Trees beginning 4744' from DER, 1583' right of centerline, up to 397' MSL.
 Trees beginning 4938' from DER, 1374' right of centerline, up to 413' MSL.
 Trees beginning 5627' from DER, 1739' right of centerline, up to 49' AGL/416' MSL.
 Tree 5667' from DER, 1763' right of centerline, 43' AGL/417' MSL.
 Trees beginning 5670' from DER, 1766' right of centerline, up to 45' AGL/423' MSL.
 Trees beginning 5785' from DER, 1779' right of centerline, up to 48' AGL/430' MSL.
 Trees beginning 5807' from DER, 1800' right of centerline, up to 50' AGL/431' MSL.
 Trees beginning 5812' from DER, 1815' right of centerline, up to 53' AGL/435' MSL.
 Trees beginning 5865' from DER, 1794' right of centerline, up to 56' AGL/437' MSL.
 Trees beginning 5874' from DER, 1816' right of centerline, up to 57' AGL/438' MSL.
 Trees beginning 5883' from DER, 1839' right of centerline, up to 61' AGL/439' MSL.
 Trees beginning 5920' from DER, 1779' right of centerline, up to 59' AGL/440' MSL.
 Trees beginning 6021' from DER, 1751' right of centerline, up to 59' AGL/444' MSL.
 Tree 1 NM from DER, 1830' right of centerline, 67' AGL/447' MSL.
 Trees beginning 1 NM from DER, 1809' right of centerline, up to 70' AGL/450' MSL.
 Tree 1.2 NM from DER, 2264' right of centerline, 59' AGL/460' MSL.
Rwy 22R, lighting 88' from DER, on centerline, 5' AGL/258' MSL.
 Lighting 297' from DER, on centerline, 8' AGL/261' MSL.
 Building 348' from DER, 478' right of centerline, 17' AGL/267' MSL.
 Vehicles on road beginning 402' from DER, 380' right of centerline, up to 268' MSL.
 Vehicles on road beginning 523' from DER, 400' right of centerline, up to 269' MSL.
 Vehicles on road 587' from DER, 646' left of centerline, 268' MSL.
 Vehicles on road 646' from DER, 570' right of centerline, 274' MSL.
 Pole, vehicles on road beginning 685' from DER, 393' right of centerline, up to 276' MSL.
 Vehicles on road 700' from DER, 680' left of centerline, 271' MSL.
 Vehicles on road 758' from DER, 683' left of centerline, 274' MSL.
 Vehicles on road beginning 792' from DER, 618' left of centerline, up to 275' MSL.
 Fence, tree, vehicles on road, pole beginning 818' from DER, 152' right of centerline, up to 32' AGL/282' MSL.
 Tree, pole, stack, building, tank beginning 910' from DER, 312' right of centerline, up to 292' MSL.
 Vehicles on road beginning 925' from DER, 642' left of centerline, up to 282' MSL.
 Vehicles on road beginning 968' from DER, 361' left of centerline, up to 285' MSL.
 Trees beginning 1204' from DER, 187' left of centerline, up to 68' AGL/305' MSL.
 Trees beginning 1334' from DER, 721' left of centerline, up to 66' AGL/307' MSL.
 Tree, pole beginning 1348' from DER, 94' right of centerline, up to 44' AGL/294' MSL.
 Tree 1623' from DER, 687' right of centerline, 302' MSL.

CON'T

22 FEB 2024 to 21 MAR 2024

22 FEB 2024 to 21 MAR 2024



TAKEOFF MINIMUMS, (OBSTACLE) DEPARTURE PROCEDURES, AND DIVERSE VECTOR AREA (RADAR VECTORS)



23278

SC-1

LITTLE ROCK, AR (CON'T)**BILL AND HILLARY CLINTON NTL/ADAMS FLD (LIT) (CON'T)****Rwy 22R (CON'T)**, trees beginning 1624' from DER, 931' left of centerline, up to 62' AGL/308' MSL.

Tree 1664' from DER, 945' left of centerline, 62' AGL/311' MSL.

Trees beginning 1674' from DER, 697' left of centerline, up to 322' MSL.

Trees beginning 1726' from DER, 270' right of centerline, up to 307' MSL.

Trees beginning 1929' from DER, 274' right of centerline, up to 61' AGL/310' MSL.

Trees beginning 1970' from DER, 297' right of centerline, up to 311' MSL.

Trees beginning 2087' from DER, 550' left of centerline, up to 330' MSL.

Tree 2136' from DER, 397' right of centerline, 315' MSL.

Trees beginning 2194' from DER, 874' left of centerline, up to 332' MSL.

Tree 2210' from DER, 481' right of centerline, 321' MSL.

Trees beginning 2478' from DER, 997' left of centerline, up to 336' MSL.

Trees beginning 2727' from DER, 1222' left of centerline, up to 345' MSL.

Trees beginning 2831' from DER, 407' left of centerline, up to 364' MSL.

Trees beginning 3023' from DER, 834' left of centerline, up to 379' MSL.

Trees beginning 3221' from DER, 578' left of centerline, up to 411' MSL.

Trees beginning 3593' from DER, 695' left of centerline, up to 413' MSL.

Trees beginning 3711' from DER, 597' left of centerline, up to 417' MSL.

Trees beginning 3995' from DER, 530' left of centerline, up to 430' MSL.

Trees beginning 4267' from DER, 749' left of centerline, up to 431' MSL.

Tree, pole, vegetation beginning 4374' from DER, 678' left of centerline, up to 447' MSL.

Trees beginning 5641' from DER, 997' left of centerline, up to 448' MSL.

Tree 5948' from DER, 1935' left of centerline, 449' MSL.

Trees beginning 5950' from DER, 1153' left of centerline, up to 457' MSL.

Trees beginning 6029' from DER, 1051' left of centerline, up to 462' MSL.

Trees beginning 1.3 NM from DER, 2662' left of centerline, up to 474' MSL.

Tree 1.4 NM from DER, 2662' left of centerline, 482' MSL.

Tree 1.4 NM from DER, 2756' left of centerline, 487' MSL.

Trees beginning 1.4 NM from DER, 2703' left of centerline, up to 491' MSL.

Tree 1.4 NM from DER, 2730' left of centerline, 499' MSL.

Trees beginning 1.5 NM from DER, 2714' left of centerline, up to 503' MSL.

Trees beginning 1.5 NM from DER, 2413' left of centerline, up to 504' MSL.

Tree, tank beginning 1.5 NM from DER, 2622' left of centerline, up to 62' AGL/513' MSL.

Trees beginning 1.6 NM from DER, 2475' left of centerline, up to 506' MSL.

Rwy 36, vehicles on road 117' from DER, 507' left of centerline, 263' MSL.

Vehicles on road 175' from DER, 538' right of centerline, 265' MSL.

Tree, pole beginning 243' from DER, 541' right of centerline, up to 347' MSL.

Tower 568' from DER, 504' left of centerline, 60' AGL/313' MSL.

Tree, pole beginning 747' from DER, 2' left of centerline, up to 345' MSL.

Tree, pole beginning 1074' from DER, 11' right of centerline, up to 354' MSL.

Trees beginning 1647' from DER, 78' left of centerline, up to 365' MSL.

Tree 3380' from DER, 830' right of centerline, 355' MSL.

Trees beginning 3456' from DER, 938' right of centerline, up to 359' MSL.

Tree 3797' from DER, 484' left of centerline, 366' MSL.

Tree 3910' from DER, 545' right of centerline, 368' MSL.

Tree 4585' from DER, 1353' right of centerline, 114' AGL/374' MSL.

LITTLE ROCK AFB (KLRF)**JACKSONVILLE, AR****TAKEOFF MINIMUMS AND (OBSTACLE) DEPARTURE PROCEDURES****AMDT 10 15JUN23 (23166) (USAF)****TAKEOFF OBSTACLES:****Rwy 7**, multiple trees 1045' from DER, 724' right of centerline, up to 80' AGL/367' MSL.

Multiple trees 1433' from DER, 674' left of centerline, up to 80' AGL/370' MSL.

Rwy 25, multiple trees 1006' from DER, 722' right of centerline, 80' AGL/364' MSL.

Multiple trees 4200' from DER, 757' left of centerline, 80' AGL/400' MSL.

22 FEB 2024 to 21 MAR 2024

22 FEB 2024 to 21 MAR 2024

TAKEOFF MINIMUMS, (OBSTACLE) DEPARTURE PROCEDURES, AND DIVERSE VECTOR AREA (RADAR VECTORS)

23278

MADILL, OK

MADILL MUNI (1F4)

TAKEOFF MINIMUMS AND (OBSTACLE) DEPARTURE PROCEDURES

AMDT 1 20OCT11 (11293) (FAA)

DEPARTURE PROCEDURE:

Rwy 18, climb heading 190° to 3100 before turning left.

Rwy 36, climb heading 360° to 1600 before proceeding on course.

TAKEOFF OBSTACLE NOTES:

Rwy 18, trees across centerline beginning 713' from DER, up to 50' AGL/920' MSL.

Rwy 36, trees beginning 432' from DER, 139' left of centerline, up to 50' AGL/890' MSL.

Trees beginning 817' from DER, 110' right of centerline, up to 50' AGL/890' MSL.

MAGNOLIA, AR

RALPH C WEISER FLD (AGO)

TAKEOFF MINIMUMS AND (OBSTACLE) DEPARTURE PROCEDURES

AMDT 1B 14SEP17 (22139) (FAA)

TAKEOFF OBSTACLE NOTES:

Rwy 18, ground 27' from DER, 389' right of centerline, 321' MSL.

Tree, ground beginning 85' from DER, 150' right of centerline, up to 8' AGL/326' MSL.

Oil pole 340' from DER, 180' left of centerline, 333' MSL.

Bush beginning 511' from DER, 185' right of centerline, up to 336' MSL.

Tree 1189' from DER, 797' right of centerline, 379' MSL.

Trees beginning 1290' from DER, 720' right of centerline, up to 387' MSL.

Tree 1337' from DER, 851' left of centerline, 372' MSL.

Trees beginning 1628' from DER, 837' left of centerline, up to 374' MSL.

Tree 1725' from DER, 738' right of centerline, 392' MSL.

Trees beginning 1780' from DER, 247' right of centerline, up to 409' MSL.

Trees beginning 1825' from DER, 880' left of centerline, up to 378' MSL.

Tree 2023' from DER, 1009' left of centerline, 381' MSL.

Pole 2035' from DER, 900' left of centerline, 383' MSL.

Trees beginning 2179' from DER, 871' left of centerline, up to 386' MSL.

Treeline beginning 2596' from DER, 94' right of centerline, up to 329' AGL/429' MSL.

Trees beginning 2642' from DER, 49' left of centerline, up to 112' AGL/455' MSL.

Trees beginning 2705' from DER, 13' right of centerline, up to 432' MSL.

Trees beginning 2872' from DER, 8' right of centerline, up to 441' MSL.

Water tower 5118' from DER, 1444' right of centerline, 135' AGL/459' MSL.

Rwy 36, NT REIL 9' from DER, 89' right of centerline, 302' MSL.

NT REIL 10' from DER, 90' left of centerline, 3' AGL/303' MSL.

Trees beginning 278' from DER, 351' right of centerline, up to 354' MSL.

Trees beginning 633' from DER, 374' left of centerline, up to 371' MSL.

Trees beginning 842' from DER, 34' left of centerline, up to 385' MSL.

Trees beginning 2121' from DER, 295' right of centerline, up to 361' MSL.

Tree 2271' from DER, 118' right of centerline, 362' MSL.

Tree 2347' from DER, 1033' right of centerline, 363' MSL.

Tree 2376' from DER, 754' right of centerline, 363' MSL.

Tree 2431' from DER, 498' right of centerline, 367' MSL.

Trees beginning 2481' from DER, 221' right of centerline, up to 376' MSL.

Trees beginning 2719' from DER, 146' right of centerline, up to 383' MSL.

MALVERN, AR

MALVERN MUNI (M78)

TAKEOFF MINIMUMS AND (OBSTACLE) DEPARTURE PROCEDURES

ORIG 10MAY07 (07130) (FAA)

TAKEOFF OBSTACLE NOTES:

Rwy 4, multiple trees beginning 456' from DER, 1' left of centerline, up to 100' AGL/649' MSL.

Multiple trees beginning 456' from DER, 1' right of centerline, up to 100' AGL/649' MSL.

Rwy 22, multiple trees and power lines beginning 241' from DER, 1' left of centerline, up to 75' AGL/604' MSL. Multiple trees and power lines beginning 241' from DER, 1' right of centerline, up to 75' AGL/604' MSL.

22 FEB 2024 to 21 MAR 2024

22 FEB 2024 to 21 MAR 2024

TAKEOFF MINIMUMS, (OBSTACLE) DEPARTURE PROCEDURES, AND DIVERSE VECTOR AREA (RADAR VECTORS)

23278

SC-1



23278

TAKEOFF MINIMUMS, (OBSTACLE) DEPARTURE PROCEDURES, AND DIVERSE VECTOR AREA (RADAR VECTORS)



MANGUM, OK

SCOTT FLD (2K4)

TAKEOFF MINIMUMS AND (OBSTACLE) DEPARTURE PROCEDURES

ORIG 10MAR11 (22139) (FAA)

TAKEOFF OBSTACLE NOTES:

Rwy 17, vehicle on road 1240' from DER, left to right of centerline, 15' AGL/1694' MSL.

Multiple trees 977' from DER, 33' right of centerline, 100' AGL/1779' MSL.

Rwy 35, vehicle on road 632' from DER, left to right of centerline, 15' AGL/1644' MSL.

MANILA, AR

MANILA MUNI (MXA)

TAKEOFF MINIMUMS AND (OBSTACLE) DEPARTURE PROCEDURES

AMDT 1 19SEP13 (13262) (FAA)

TAKEOFF OBSTACLE NOTES:

Rwy 18, pole 140' from DER, 440' right of centerline, 26' AGL/266' MSL.

Pole 529' from DER, 449' right of centerline, 39' AGL/279' MSL.

Tank 211' from DER, 190' left of centerline, 13' AGL/253' MSL.

Trees beginning 1807' from DER, left and right of centerline, up to 95' AGL/334' MSL.

Rwy 36, pole 584' from DER, 554' left of centerline, 33' AGL/270' MSL.

Pole 585' from DER, 530' right of centerline, 28' AGL/268' MSL.

Vehicle on road 569' from DER, 4' left of centerline, 24' AGL/265' MSL.

Trees beginning 811' from DER, left and right of centerline, up to 116' AGL/351' MSL.

MARIANNA, AR

MARIANNA/LEE COUNTY-STEVE EDWARDS FLD (6M7)

TAKEOFF MINIMUMS AND (OBSTACLE) DEPARTURE PROCEDURES

AMDT 1 22AUG13 (21112) (FAA)

TAKEOFF OBSTACLE NOTES:

Rwy 18, tank 27' from DER, 353' right of centerline, 10' AGL/225' MSL.

Multiple poles and trees beginning 83' from DER, 372' right of centerline, up to 63' AGL/287' MSL.

Vehicles on road beginning 109' from DER, 445' right of centerline, up to 17' AGL/234' MSL.

Wall 183' from DER, 410' right of centerline, 8' AGL/225' MSL.

Rwy 36, vehicles on road beginning 92' from DER, 421' left of centerline, up to 17' AGL/227' MSL.

Multiple poles and trees beginning 137' from DER, 370' left of centerline, up to 107' AGL/323' MSL.

Multiple trees beginning 592' from DER, 550' right of centerline, up to 52' AGL/266' MSL.

MARSHALL, AR

SEARCY COUNTY (4A5)

TAKEOFF MINIMUMS AND (OBSTACLE) DEPARTURE PROCEDURES

ORIG 04FEB16 (16035) (FAA)

TAKEOFF MINIMUMS:

Rwy 5, std. w/min. climb of 448' per NM to 1500, or 1800-3 for climb in visual conditions.**Rwy 23**, std. w/min. climb of 354' per NM to 2200, or 1800-3 for climb in visual conditions.

DEPARTURE PROCEDURE:

Rwy 5, climb heading 051° to 2100 before proceeding on course.**Rwy 23**, climb heading 231° to 2600 before proceeding on course.

VCOA:

Rwy 5, obtain ATC approval for climb in visual conditions when requesting IFR clearance. Climb in visual conditions to cross Searcy County airport at or above 2600 before proceeding on course.**Rwy 23**, obtain ATC approval for climb in visual conditions when requesting IFR clearance. Climb in visual conditions to cross Searcy County airport at or above 2600 before proceeding on course.

TAKEOFF OBSTACLE NOTES:

Rwy 5, rising terrain beginning 3' from DER, 300' left and 138' right of centerline, up to 978' MSL.

Rising terrain beginning 67' from DER, 389' right of centerline, up to 990' MSL.

Trees and pole beginning 24' from DER, 263' left and 338' right of centerline, up to 137' AGL/1039' MSL.

Sign 26' from DER, 197' left of centerline, 3' AGL/966' MSL.

Trees beginning 303' from DER, 71' right of centerline, up to 65' AGL/1020' MSL.

Trees, poles and t-l towers beginning 976' from DER, 95' right of centerline, up to 107' AGL/1034' MSL.

Trees, poles and t-l towers beginning 990' from DER, 273' left of centerline, up to 99' AGL/1025' MSL.

Tree 3006' from DER, 688' left of centerline, 97' AGL/1050' MSL.

Trees, poles and tower beginning 4742' from DER, 1301' left of centerline, up to 100' AGL/1114' MSL.

Trees beginning 4776' from DER, 1514' right of centerline, up to 92' AGL/1107' MSL.

Rwy 23, rising terrain beginning 4' from DER, 144' left and 180' right of centerline, up to 945' MSL.

Trees beginning 7' from DER, 401' left of centerline, up to 79' AGL/995' MSL.

Trees beginning 43' from DER, 274' right of centerline, up to 29' AGL/967' MSL.

Trees beginning 70' from DER, 491' right of centerline, up to 62' AGL/1003' MSL.

Trees beginning 395' from DER, 269' right of centerline, up to 88' AGL/965' MSL.

22 FEB 2024 to 21 MAR 2024

22 FEB 2024 to 21 MAR 2024



23278

TAKEOFF MINIMUMS, (OBSTACLE) DEPARTURE PROCEDURES, AND DIVERSE VECTOR AREA (RADAR VECTORS)



SC-1



TAKEOFF MINIMUMS, (OBSTACLE) DEPARTURE PROCEDURES, AND DIVERSE VECTOR AREA (RADAR VECTORS)



23278

MC ALESTER, OK

MC ALESTER RGNL (MLC)

TAKEOFF MINIMUMS AND (OBSTACLE) DEPARTURE PROCEDURES

ORIG-A 02JUL09 (09183) (FAA)

TAKEOFF MINIMUMS:

Rwy 2, 300-1½ or std. w/min. climb of 318' per NM to 1100.**Rwy 20**, 300-2 or std. w/min. climb of 232' per NM to 1100 or alternatively, with std. takeoff minimums and a normal 200'/NM climb gradient, takeoff must occur no later than 1900' prior to DER.

TAKEOFF OBSTACLE NOTES:

Rwy 2, light standard, tree and pole beginning 203' from DER, 302' right of centerline, up to 59' AGL/828' MSL.

Pole 104' from DER, 276' left of centerline, 31' AGL/780' MSL.

Tree 5344' from DER, 1912' left of centerline, 100' AGL/989' MSL.

Rwy 20, multiple trees and poles beginning 715' from DER, 66' right and 97' left of centerline, up to 50' AGL/934' MSL.

Radio mast 9021' from DER, 2565' right of centerline, 266' AGL/985' MSL.

MC GEHEE, AR

MC GEHEE MUNI (7M1)

TAKEOFF MINIMUMS AND (OBSTACLE) DEPARTURE PROCEDURES

ORIG 15DEC11 (11349) (FAA)

TAKEOFF OBSTACLE NOTES:

Rwy 18, trees beginning 2594' from DER, left and right of centerline, up to 100' AGL/234' MSL.**Rwy 36**, trees beginning 456' from DER, 365' left of centerline, up to 100' AGL/244' MSL.

Trees beginning 2143' from DER, 1048' right of centerline, up to 100' AGL/244' MSL.

Trees beginning 2404' from DER, 899' left of centerline, up to 100' AGL/244' MSL.

MELBOURNE, AR

MELBOURNE MUNI - JOHN E MILLER FLD (42A)

TAKEOFF MINIMUMS AND (OBSTACLE) DEPARTURE PROCEDURES

AMDT 1 24MAY18 (22139) (FAA)

TAKEOFF MINIMUMS:

Rwy 21, 300-1¼ or std. w/ min. climb of 235' per NM to 1000 or alternatively, with std. takeoff minimums and a normal 200' per NM climb gradient, takeoff must occur no later than 2000' prior to DER.

TAKEOFF OBSTACLE NOTES:

Rwy 3, vegetation 1' from DER, 384' right of centerline, 710' MSL.

Tree, vegetation beginning 22' from DER, 252' right of centerline, up to 39' AGL/733' MSL.

Tree 151' from DER, 510' left of centerline, 723' MSL.

Tree 297' from DER, 577' left of centerline, 725' MSL.

Tree 427' from DER, 519' left of centerline, 737' MSL.

Trees beginning 537' from DER, 552' left of centerline, up to 749' MSL.

Trees beginning 1044' from DER, 643' right of centerline, up to 757' MSL.

Tree 1234' from DER, 582' right of centerline, 771' MSL.

Tree 1332' from DER, 528' right of centerline, 775' MSL.

Tree 1426' from DER, 472' right of centerline, 777' MSL.

Trees beginning 1519' from DER, 314' right of centerline, up to 792' MSL.

Tree 2322' from DER, 712' left of centerline, 781' MSL.

Tree 2990' from DER, 426' left of centerline, 785' MSL.

Tree 3099' from DER, 426' left of centerline, 789' MSL.

Tree 3212' from DER, 753' left of centerline, 796' MSL.

Tree 3244' from DER, 1270' left of centerline, 797' MSL.

Trees beginning 3359' from DER, 378' left of centerline, up to 806' MSL.

Tree 3467' from DER, 76' right of centerline, 796' MSL.

Rwy 21, fence, terrain, vegetation beginning 16' from DER, 357' left of centerline, up to 756' MSL.

Tree, vegetation beginning 31' from DER, 267' right of centerline, up to 69' AGL/786' MSL.

Trees beginning 170' from DER, 500' right of centerline, up to 79' AGL/789' MSL.

Trees beginning 652' from DER, 509' right of centerline, up to 790' MSL.

Trees beginning 983' from DER, 505' right of centerline, up to 792' MSL.

Trees beginning 1164' from DER, 548' left of centerline, up to 806' MSL.

Trees beginning 1180' from DER, 503' right of centerline, up to 793' MSL.

Trees beginning 1357' from DER, 528' left of centerline, up to 807' MSL.

Trees beginning 1526' from DER, 524' right of centerline, up to 794' MSL.

Trees beginning 1615' from DER, 515' left of centerline, up to 813' MSL.

Trees beginning 1666' from DER, 746' right of centerline, up to 797' MSL.

Tree 1732' from DER, 843' right of centerline, 800' MSL.

Trees beginning 1778' from DER, 482' left of centerline, up to 819' MSL.

Tree 1791' from DER, 560' right of centerline, 801' MSL.

Trees beginning 1823' from DER, 528' right of centerline, up to 805' MSL.

Tree 2057' from DER, 733' right of centerline, 808' MSL.

Trees beginning 2081' from DER, 493' right of centerline, up to 811' MSL.

Trees beginning 2212' from DER, 353' right of centerline, up to 813' MSL.

Trees beginning 2298' from DER, 239' right of centerline, up to 814' MSL.

Tree 2725' from DER, 1014' left of centerline, 822' MSL.

Trees beginning 2740' from DER, 1074' left of centerline, up to 830' MSL.

CONT

22 FEB 2024 to 21 MAR 2024

22 FEB 2024 to 21 MAR 2024



TAKEOFF MINIMUMS, (OBSTACLE) DEPARTURE PROCEDURES, AND DIVERSE VECTOR AREA (RADAR VECTORS)



23278

SC-1

TAKEOFF MINIMUMS, (OBSTACLE) DEPARTURE PROCEDURES, AND DIVERSE VECTOR AREA (RADAR VECTORS)

23278

MELBOURNE, AR (CON'T)

MELBOURNE MUNI - JOHN E MILLER FLD (42A) (CON'T)

- Rwy 21 (CON'T)**, trees beginning 2895' from DER, 1139' left of centerline, up to 838' MSL.
 Trees beginning 3510' from DER, 839' right of centerline, up to 831' MSL.
 Tree 3627' from DER, 791' right of centerline, 833' MSL.
 Tree 3928' from DER, 68' left of centerline, 842' MSL.
 Trees beginning 3952' from DER, 33' right of centerline, up to 852' MSL.
 Tree 4047' from DER, 97' left of centerline, 846' MSL.
 Tree 4857' from DER, 1721' left of centerline, 858' MSL.
 Tree 5119' from DER, 1713' left of centerline, 873' MSL.
 Trees beginning 5211' from DER, 1646' left of centerline, up to 874' MSL.
 Tree 5465' from DER, 239' left of centerline, 876' MSL.
 Tree 5582' from DER, 399' left of centerline, 880' MSL.
 Tree 5618' from DER, 265' left of centerline, 887' MSL.
 Trees beginning 5708' from DER, 199' left of centerline, up to 894' MSL.
 Trees beginning 5817' from DER, 45' left of centerline, up to 897' MSL.
 Trees beginning 5913' from DER, 210' left of centerline, up to 899' MSL.
 Tree 6002' from DER, 25' right of centerline, 69' AGL/899' MSL.
 Tree 6012' from DER, 64' left of centerline, 69' AGL/902' MSL.
 Tank 1 NM from DER, 198' left of centerline, 92' AGL/925' MSL.

MENA, AR

MENA INTERMOUNTAIN MUNI (MEZ)

TAKEOFF MINIMUMS AND (OBSTACLE) DEPARTURE PROCEDURES

AMDT 6 03JAN19 (19003) (FAA)

TAKEOFF MINIMUMS:

- Rwy 17**, std. w/min. climb of 435' per NM to 2700 or 1900-3 for climb in visual conditions.
Rwy 27, std. w/min. climb of 425' per NM to 2100 or 1900-3 for climb in visual conditions.
Rwy 35, std. w/min. climb of 465' per NM to 3300 or 1900-3 for climb in visual conditions.

DEPARTURE PROCEDURE:

- Rwy 9**, climb heading 089° to 2100 before turning right.
Rwy 17, climb heading 170° to 2800 before turning right.
Rwy 27, climb heading 269° to 2000 before turning left.

VCOA:

- Rwys 17, 27, 35**, obtain ATC approval for VCOA when requesting IFR clearance. Climb in visual conditions to cross Mena Intermountain Municipal Airport at or above 2800 before proceeding on course.

TAKEOFF OBSTACLE NOTES:

- Rwy 9**, lighting 10' from DER, 28' right of centerline, 2' AGL/1051' MSL.
 Lighting, NAVAID beginning 11' from DER, 28' left of centerline, up to 2' AGL/1051' MSL.
 Vegetation 66' from DER, 479' left of centerline, 1058' MSL.
Rwy 17, NAVAID 39' from DER, 75' right of centerline, 3' AGL/1081' MSL.
 NAVAID 39' from DER, 76' left of centerline, 3' AGL/1081' MSL.
 Vegetation 444' from DER, 604' left of centerline, 1092' MSL.
 Tree 657' from DER, 611' left of centerline, 1109' MSL.
 Trees beginning 831' from DER, 147' left of centerline, up to 1110' MSL.
 Tree 1080' from DER, 755' left of centerline, 1146' MSL.
 Tree 3764' from DER, 1176' left of centerline, 1183' MSL.
 Tree 3957' from DER, 58' left of centerline, 1187' MSL.
 Trees beginning 1.5 NM from DER, 132' left of centerline, up to 1355' MSL.
 Tree 1.5 nm from DER, 2400' right of centerline, 1328' MSL.
 Tree 1.5 NM from DER, 93' right of centerline, 1338' MSL.
 Trees beginning 1.5 nm from DER, 2229' right of centerline, up to 1354' MSL.
 Trees beginning 1.5 NM from DER, 141' left of centerline, up to 1412' MSL.
 Trees beginning 1.6 NM from DER, 299' right of centerline, up to 1387' MSL.
 Trees beginning 1.6 NM from DER, 413' left of centerline, up to 1419' MSL.
 Tree 1.6 NM from DER, 37' right of centerline, 1455' MSL.
 Trees beginning 1.6 NM from DER, 269' right of centerline, up to 1469' MSL.
 Tree 1.6 NM from DER, 156' left of centerline, 1464' MSL.
 Trees beginning 1.6 NM from DER, 1660' left of centerline, up to 1471' MSL.
 Trees beginning 1.6 NM from DER, 437' left of centerline, up to 1487' MSL.
 Trees beginning 1.6 NM from DER, 524' right of centerline, up to 1486' MSL.
 Tree 1.6 NM from DER, 254' right of centerline, 1541' MSL.
 Tree 1.6 NM from DER, 238' left of centerline, 1537' MSL.
 Trees beginning 1.6 NM from DER, 37' right of centerline, up to 1586' MSL.
 Trees beginning 1.6 NM from DER, 851' left of centerline, up to 1542' MSL.
 Trees beginning 1.7 NM from DER, 84' left of centerline, up to 1631' MSL.
 Trees beginning 1.8 nm from DER, 211' left of centerline, up to 1658' MSL.
 Trees, pole beginning 1.8 NM from DER, 39' right of centerline, up to 1591' MSL.
 Trees beginning 2.1 NM from DER, 2255' right of centerline, up to 1634' MSL.
 Trees beginning 2.2 NM from DER, 1778' right of centerline, up to 1652' MSL.
 Trees beginning 2.2 NM from DER, 2711' right of centerline, up to 1666' MSL.
 Trees beginning 2.3 NM from DER, 74' right of centerline, up to 1689' MSL.
 Trees beginning 2.4 NM from DER, 440' right of centerline, up to 1708' MSL.
 Trees beginning 2.5 NM from DER, 18' right of centerline, up to 1754' MSL.

CON'T

TAKEOFF MINIMUMS, (OBSTACLE) DEPARTURE PROCEDURES, AND DIVERSE VECTOR AREA (RADAR VECTORS)

23278

SC-1

TAKEOFF MINIMUMS, (OBSTACLE) DEPARTURE PROCEDURES, AND DIVERSE VECTOR AREA (RADAR VECTORS)

23278

MENA, AR (CON'T)

MENA INTERMOUNTAIN MUNI (MEZ) (CON'T)

Rwy 17 (CON'T), pole, trees beginning 2.5 NM from DER, 218' left of centerline, up to 57' AGL/1767' MSL.

Tree 2.5 NM from DER, 824' left of centerline, 1796' MSL.

Tree 2.5 NM from DER, 1144' left of centerline, 1831' MSL.

Rwy 27, NAVAID 39' from DER, 90' left of centerline, 2' AGL/1079' MSL.

NAVAID 39' from DER, 89' right of centerline, 1079' MSL.

Tree 333' from DER, 537' right of centerline, 1099' MSL.

Trees beginning 415' from DER, 327' right of centerline, up to 1108' MSL.

Trees beginning 723' from DER, 515' right of centerline, up to 1109' MSL.

Trees beginning 946' from DER, 450' right of centerline, up to 1110' MSL.

Tree 1070' from DER, 471' right of centerline, 1112' MSL.

Tree 1124' from DER, 573' left of centerline, 1110' MSL.

Tree 1184' from DER, 694' right of centerline, 1127' MSL.

Trees beginning 1201' from DER, 380' left of centerline, up to 1148' MSL.

Trees beginning 1411' from DER, 110' right of centerline, up to 1145' MSL.

Trees beginning 1658' from DER, 496' left of centerline, up to 1149' MSL.

Trees beginning 1875' from DER, 449' right of centerline, up to 1146' MSL.

Trees beginning 1913' from DER, 271' right of centerline, up to 1152' MSL.

Trees beginning 2074' from DER, 163' left of centerline, up to 1152' MSL.

Trees beginning 2122' from DER, 34' left of centerline, up to 1158' MSL.

Tree 2165' from DER, 117' right of centerline, 1155' MSL.

Trees beginning 2201' from DER, 208' right of centerline, up to 1157' MSL.

Trees beginning 2302' from DER, 14' right of centerline, up to 1162' MSL.

Trees beginning 2471' from DER, 155' left of centerline, up to 1159' MSL.

Trees beginning 2567' from DER, 5' right of centerline, up to 1164' MSL.

Trees beginning 2634' from DER, 319' left of centerline, up to 1165' MSL.

Trees beginning 2743' from DER, 121' left of centerline, up to 1167' MSL.

Trees beginning 2789' from DER, 107' right of centerline, up to 1167' MSL.

Trees beginning 2950' from DER, 13' left of centerline, up to 1169' MSL.

Trees beginning 2973' from DER, 79' right of centerline, up to 1175' MSL.

Trees beginning 3163' from DER, 75' left of centerline, up to 1171' MSL.

Trees beginning 3297' from DER, 862' right of centerline, up to 1176' MSL.

Tree 4266' from DER, 482' right of centerline, 1186' MSL.

Tree 1.3 NM from DER, 2513' left of centerline, 1292' MSL.

Tree 1.4 NM from DER, 2508' left of centerline, 1295' MSL.

Tree 1.5 NM from DER, 2542' left of centerline, 1315' MSL.

Tree 1.5 NM from DER, 2775' left of centerline, 1401' MSL.

Tree 1.5 NM from DER, 2547' left of centerline, 1413' MSL.

Trees beginning 1.5 NM from DER, 2167' left of centerline, up to 1424' MSL.

Tree 1.5 NM from DER, 2665' left of centerline, 1445' MSL.

Trees beginning 1.5 NM from DER, 2156' left of centerline, up to 1500' MSL.

Trees beginning 1.5 NM from DER, 1896' left of centerline, up to 1529' MSL.

Trees, buildings beginning 1.6 NM from DER, 1928' left of centerline, up to 1592' MSL.

Building, trees beginning 1.8 NM from DER, 1384' left of centerline, up to 27' AGL/1609' MSL.

Trees beginning 1.8 NM from DER, 868' left of centerline, up to 1615' MSL.

Trees beginning 1.9 NM from DER, 685' left of centerline, up to 1652' MSL.

Building, trees beginning 1.9 NM from DER, 259' left of centerline, up to 51' AGL/1715' MSL.

Trees beginning 2.1 NM from DER, 53' right of centerline, up to 1449' MSL.

Tree, pole beginning 2.2 NM from DER, 320' right of centerline, up to 1462' MSL.

Rwy 35, buildings beginning 26' from DER, 365' right of centerline, up to 30' AGL/1069' MSL.

Trees, pole beginning 106' from DER, 41' left of centerline, up to 1106' MSL.

Trees beginning 641' from DER, 425' right of centerline, up to 1120' MSL.

Trees beginning 1074' from DER, 117' right of centerline, up to 1130' MSL.

Tree 2146' from DER, 60' left of centerline, 1120' MSL.

MIAMI, OK

MIAMI RGNL (MIO)

TAKEOFF MINIMUMS AND (OBSTACLE) DEPARTURE PROCEDURES

ORIG-A 26MAY16 (16147) (FAA)

TAKEOFF OBSTACLE NOTES:

Rwy 17, buildings, trees, and power lines beginning 772' from DER, 339' left of centerline, up to 100' AGL/899' MSL.

Building 3539' from DER, 738' right of centerline, 100' AGL/899' MSL.

Rwy 35, building, trees, and power lines beginning 1398' from DER, 449' right of centerline, up to 100' AGL/919' MSL.

22 FEB 2024 to 21 MAR 2024

22 FEB 2024 to 21 MAR 2024

TAKEOFF MINIMUMS, (OBSTACLE) DEPARTURE PROCEDURES, AND DIVERSE VECTOR AREA (RADAR VECTORS)

23278

SC-1

TAKEOFF MINIMUMS, (OBSTACLE) DEPARTURE PROCEDURES, AND

DIVERSE VECTOR AREA (RADAR VECTORS)

23278

MONTICELLO, AR

MONTICELLO MUNI/ELLIS FLD (LLQ)

TAKEOFF MINIMUMS AND (OBSTACLE) DEPARTURE PROCEDURES

ORIG-A 23JUN16 (21280) (FAA)

TAKEOFF MINIMUMS:

Rwy 21, 300-1½ or std. w/min. climb of 436' per NM to 600.

TAKEOFF OBSTACLE NOTES:

Rwy 3, tree 278' from DER, 544' left of centerline, 100' AGL/349' MSL.

Vehicle on road 625' from DER, 628' right of centerline, 15' AGL/264' MSL.

Rwy 21, tree 3687' from DER, 819' left of centerline, 100' AGL/469' MSL.

Vehicle on road 1000' from DER, 676' left of centerline, 15' AGL/294' MSL.

Trees beginning 435' from DER, 607' right of centerline, up to 100' AGL/399' MSL.

Power line 5621' from DER, 994' right of centerline, 79' AGL/458' MSL.

Power line 4504' from DER, 1652' right of centerline, 79' AGL/388' MSL.

Trees beginning 6722' from DER, 963' right of centerline, up to 110' AGL/470' MSL.

MOORELAND, OK

MOORELAND MUNI (MDF)

TAKEOFF MINIMUMS AND (OBSTACLE) DEPARTURE PROCEDURES

ORIG 20OCT11 (11293) (FAA)

TAKEOFF OBSTACLE NOTES:

Rwy 17, trees beginning 191' from DER, 182' right of centerline, up to 50' AGL/2003' MSL.

Trees beginning 421' from DER, 337' left of centerline, up to 50' AGL/2006' MSL.

Power pole 498' from DER, 176' right of centerline, 35' AGL/1992' MSL.

Rwy 35, power pole 1225' from DER, 43' left of centerline, 35' AGL/2004' MSL.**MORRILTON, AR**

MORRILTON MUNI (BDQ)

TAKEOFF MINIMUMS AND (OBSTACLE) DEPARTURE PROCEDURES

ORIG-A 08MAY08 (08129) (FAA)

TAKEOFF MINIMUMS:

Rwy 27, Std. w/ min. climb of 211' per NM to 1600 or 900-2½ for climb in visual conditions.

DEPARTURE PROCEDURE:

Rwy 27, For climb in visual conditions cross Morrilton Municipal Airport at or above 1100 MSL before proceeding on course.

TAKEOFF OBSTACLE NOTES:

Rwy 9, trees beginning 321' from DER, 511' right of centerline up to 100' AGL/419' MSL.

Trees beginning 3378' from DER, 346' left of centerline, up to 100' AGL/449' MSL.

Rwy 27, trees beginning 814' from DER, 317' left of centerline up to 100' AGL/399' MSL.

Trees beginning 1552' from DER, 6' right of centerline up to 100' AGL/429' MSL.

PETIT JEAN PARK (MPJ)

TAKEOFF MINIMUMS AND (OBSTACLE) DEPARTURE PROCEDURES

AMDT 2 24MAY18 (18144) (FAA)

TAKEOFF MINIMUMS:

Rwy 3, 300-1½ or std. w/min. climb of 326' per NM to 1300.**Rwy 21**, 300-2 or std. w/min. climb of 366' per NM to 1300.

TAKEOFF OBSTACLE NOTES:

Rwy 3, pole, traverse way beginning 47' from DER, 447' left of centerline, up to 28' AGL/968' MSL.

Tree, traverse way beginning 162' from DER, 243' left of centerline, up to 51' AGL/995' MSL.

Tree, pole, traverse way beginning 205' from DER, 1' right of centerline, up to 48' AGL/962' MSL.

Tree, pole beginning 359' from DER, 224' right of centerline, up to 53' AGL/972' MSL.

Tree, pole beginning 496' from DER, 173' right of centerline, up to 62' AGL/985' MSL.

Tree, pole, building beginning 588' from DER, 160' right of centerline, up to 66' AGL/992' MSL.

Trees beginning 797' from DER, 91' left of centerline, up to 64' AGL/1008' MSL.

Tree 1040' from DER, 356' left of centerline, 78' AGL/1009' MSL.

Trees beginning 1150' from DER, 92' left of centerline, up to 80' AGL/1020' MSL.

Tree 1162' from DER, 6' right of centerline, 59' AGL/1003' MSL.

Tree 1236' from DER, 678' right of centerline, 73' AGL/1023' MSL.

Trees beginning 1430' from DER, 16' right of centerline, up to 73' AGL/1028' MSL.

Trees beginning 1858' from DER, 101' left of centerline, up to 88' AGL/1030' MSL.

Trees beginning 2520' from DER, 16' left of centerline, up to 55' AGL/1039' MSL.

Tree 2579' from DER, 233' right of centerline, 48' AGL/1035' MSL.

Tree 2640' from DER, 440' left of centerline, 54' AGL/1042' MSL.

Trees beginning 2712' from DER, 11' right of centerline, up to 57' AGL/1051' MSL.

Tree 2808' from DER, 53' left of centerline, 50' AGL/1049' MSL.

Trees beginning 2993' from DER, 55' left of centerline, up to 58' AGL/1053' MSL.

Tree 3594' from DER, 38' right of centerline, 56' AGL/1056' MSL.

Tree 3733' from DER, 1385' right of centerline, 73' AGL/1064' MSL.

Tree 3748' from DER, 937' right of centerline, 79' AGL/1071' MSL.

Tree 5154' from DER, 654' right of centerline, 81' AGL/1133' MSL.

Tree 1 NM from DER, 958' left of centerline, 61' AGL/1157' MSL.

CON'T

22 FEB 2024 to 21 MAR 2024

22 FEB 2024 to 21 MAR 2024

TAKEOFF MINIMUMS, (OBSTACLE) DEPARTURE PROCEDURES, AND

DIVERSE VECTOR AREA (RADAR VECTORS)

23278

SC-1

TAKEOFF MINIMUMS, (OBSTACLE) DEPARTURE PROCEDURES, AND DIVERSE VECTOR AREA (RADAR VECTORS)

23278

MORRILTON, AR (CON'T)

PETIT JEAN PARK (MPJ) (CON'T)

Rwy 21, fence 2' from DER, 250' right of centerline, 12' AGL/896' MSL.
 Tree 116' from DER, 367' right of centerline, 60' AGL/944' MSL.
 Tree 1018' from DER, 420' left of centerline, 53' AGL/939' MSL.
 Tree 1134' from DER, 672' left of centerline, 69' AGL/962' MSL.
 Tree 1181' from DER, 478' left of centerline, 92' AGL/984' MSL.
 Trees beginning 1350' from DER, 60' left of centerline, up to 91' AGL/987' MSL.
 Tree 1390' from DER, 521' right of centerline, 81' AGL/964' MSL.
 Tree 1568' from DER, 663' right of centerline, 86' AGL/972' MSL.
 Tree, building beginning 1588' from DER, 314' right of centerline, up to 90' AGL/982' MSL.
 Tree 1638' from DER, 208' left of centerline, 93' AGL/996' MSL.
 Tree, traverse way beginning 1765' from DER, 52' left of centerline, up to 93' AGL/997' MSL.
 Tree 1909' from DER, 679' left of centerline, 88' AGL/1007' MSL.
 Trees beginning 2067' from DER, 36' left of centerline, up to 96' AGL/1015' MSL.
 Trees beginning 2101' from DER, 62' right of centerline, up to 84' AGL/997' MSL.
 Tree, building, pole beginning 2287' from DER, 247' left of centerline, up to 82' AGL/1016' MSL.
 Tree 2579' from DER, 1184' right of centerline, 90' AGL/1002' MSL.
 Tree, pole beginning 2909' from DER, 268' right of centerline, up to 83' AGL/1019' MSL.
 Trees beginning 3104' from DER, 40' right of centerline, up to 83' AGL/1029' MSL.
 Tree, pole beginning 3165' from DER, 44' left of centerline, up to 75' AGL/1037' MSL.
 Tree, pole beginning 3504' from DER, 14' left of centerline, up to 68' AGL/1049' MSL.
 Trees beginning 4070' from DER, 1187' right of centerline, up to 77' AGL/1031' MSL.
 Tree 4375' from DER, 419' right of centerline, 87' AGL/1033' MSL.
 Trees beginning 4405' from DER, 99' right of centerline, up to 90' AGL/1034' MSL.
 Tree 1.2 NM from DER, 2579' left of centerline, 64' AGL/1198' MSL.

MOUNTAIN HOME, AR

BAXTER COUNTY (BPK)

TAKEOFF MINIMUMS AND (OBSTACLE) DEPARTURE PROCEDURES

AMDT 4 13SEP18 (18256) (FAA)

TAKEOFF OBSTACLE NOTES:

Rwy 5, tree 51' from DER, 304' right of centerline, 962' MSL.
 Tree 196' from DER, 400' right of centerline, 964' MSL.
 Tree 303' from DER, 438' left of centerline, 943' MSL.
 Tree 362' from DER, 464' right of centerline, 971' MSL.
 Tree, pole beginning 509' from DER, 37' right of centerline, up to 976' MSL.
 Tree, pole beginning 719' from DER, 53' left of centerline, up to 972' MSL.
 Transmission line 1231' from DER, 261' left of centerline, 61' AGL/975' MSL.
 Pole, transmission line beginning 1654' from DER, 257' right of centerline, up to 984' MSL.
 Tree 2120' from DER, 552' left of centerline, 1017' MSL.
 Pole 2713' from DER, 250' right of centerline, 49' AGL/1010' MSL.
Rwy 23, trees beginning 197' from DER, 376' left of centerline, up to 979' MSL.
 Trees beginning 460' from DER, 463' right of centerline, up to 970' MSL.
 Tree 1437' from DER, 650' right of centerline, 989' MSL.
 Tree 1642' from DER, 579' left of centerline, 998' MSL.
 Tree 1726' from DER, 876' left of centerline, 1000' MSL.

MOUNTAIN VIEW, AR

MOUNTAIN VIEW WILCOX MEML FLD (7M2)

TAKEOFF MINIMUMS AND (OBSTACLE) DEPARTURE PROCEDURES

AMDT 2 30MAR17 (22307) (FAA)

TAKEOFF MINIMUMS:

Rwy 9, std. w/min. climb of 450' per NM to 2200, or 2200-2½ for VCOA.

DEPARTURE PROCEDURE:

Rwy 9, climb heading 092° to 2100 before turning.

Rwy 27, climb heading 272° to 2800 before turning.

VCOA:

Rwy 9, obtain ATC approval for VCOA when requesting IFR clearance. Climb in visual conditions to cross Mountain View Wilcox Meml Fld at or above 2100 before proceeding on course.

MULDROW AHP (KHMY)

LEXINGTON, OK

TAKEOFF MINIMUMS AND (OBSTACLE) DEPARTURE PROCEDURES

AMDT 2 07SEP23 (23250) (USA)

TAKEOFF MINIMUMS:

Rwys 17, 35, std COPTER only.

TAKEOFF OBSTACLE NOTES:

Rwy 17, trees, poles, bldgs, fuel tanks beginning 21' from DER, left and right of centerline, up to 60' AGL/1150' MSL.

Rwy 35, trees, bldgs beginning 44' from DER, left and right of centerline, up to 70' AGL/1160' MSL.

TAKEOFF MINIMUMS, (OBSTACLE) DEPARTURE PROCEDURES, AND DIVERSE VECTOR AREA (RADAR VECTORS)

23278

SC-1

TAKEOFF MINIMUMS, (OBSTACLE) DEPARTURE PROCEDURES, AND DIVERSE VECTOR AREA (RADAR VECTORS)

23278

MUSKOGEE, OK

MUSKOGEE-DAVIS RGNL (MKO)

TAKEOFF MINIMUMS AND (OBSTACLE) DEPARTURE PROCEDURES

ORIG-A 01MAR18 (18060) (FAA)

TAKEOFF MINIMUMS:

Rwys 18, 36, NA-Environmental.

Rwy 22, 200-1½ or std. w/ min. climb of 436' per NM to 900.

Rwy 31, 300-1½ or std. w/ min. climb of 217' per NM to 900, or alternatively, with standard takeoff minimums and a normal 200' per NM climb gradient, takeoff must occur no later than 1700' prior to DER.

TAKEOFF OBSTACLE NOTES:

Rwy 22, tree 3637' from DER, 985' right of centerline, 100' AGL/809' MSL.

Rwy 31, tree 7679' from DER, 851' left of centerline, 100' AGL/819' MSL.

NASHVILLE, AR

HOWARD COUNTY (M77)

TAKEOFF MINIMUMS AND (OBSTACLE) DEPARTURE PROCEDURES

ORIG 09FEB12 (12040) (FAA)

TAKEOFF OBSTACLE NOTES:

Rwy 1, fence and trees beginning 16' from DER, 259' left of centerline, up to 70' AGL/613' MSL.

Trees beginning 49' from DER, 344' right of centerline, up to 76' AGL/601' MSL.

Rwy 19, trees, buildings, poles, antenna, catenary, and road beginning 12' from DER, 200' left of centerline, up to 97' AGL/592' MSL.

Trees and catenary beginning 85' from DER, 241' right of centerline, up to 92' AGL/591' MSL.

NEWPORT, AR

NEWPORT RGNL (M19)

TAKEOFF MINIMUMS AND (OBSTACLE) DEPARTURE PROCEDURES

ORIG-A 01FEB18 (18032) (FAA)

TAKEOFF OBSTACLE NOTES:

Rwy 22, building beginning 1947' from DER, 452' right of centerline, 60' AGL/299' MSL.

Rwy 36, trees 2163' from DER, 939' left of centerline, up to 100' AGL/339' MSL.

NORMAN, OK

UNIVERSITY OF OKLAHOMA WESTHEIMER (OUN)

TAKEOFF MINIMUMS AND (OBSTACLE) DEPARTURE PROCEDURES

AMDT 1A 26MAY16 (16147) (FAA)

TAKEOFF OBSTACLE NOTES:

Rwy 3, tower and elevators beginning 1451' from DER, 359' right of centerline, up to 59' AGL/1236' MSL.

Rwy 18, tree 97' from DER, 449' right of centerline, 32' AGL/1208' MSL.

Rwy 21, tree 162' from DER, 461' right of centerline, 25' AGL/1201' MSL.

Trees beginning 874' from DER, 484' right of centerline, up to 27' AGL/1208' MSL.

Trees beginning 1211' from DER, 463' left of centerline, up to 39' AGL/1210' MSL.

Light pole 1243' from DER, 745' right of centerline, 32' AGL/1213' MSL.

Rwy 36, poles beginning 700' from DER, 518' right of centerline, up to 44' AGL/1215' MSL.

NORTH LITTLE ROCK, AR

NORTH LITTLE ROCK MUNI (ORK)

TAKEOFF MINIMUMS AND (OBSTACLE) DEPARTURE PROCEDURES

ORIG-A 15AUG19 (19227) (FAA)

TAKEOFF OBSTACLE NOTES:

Rwy 5, tree 166' from DER, 389' right of centerline, 553' MSL.

Trees beginning 333' from DER, 495' right of centerline, up to 566' MSL.

Tree 1298' from DER, 272' left of centerline, 553' MSL.

Tree 1371' from DER, 796' left of centerline, 572' MSL.

Rwy 17, pole and wind indicator beginning 52' from DER, 224' right of centerline, up to 9' AGL/547' MSL.

Tree 618' from DER, 628' left of centerline, 558' MSL.

Trees beginning 1102' from DER, 83' right of centerline, up to 579' MSL.

Tree 1106' from DER, 11' left of centerline, 574' MSL.

Tree 1213' from DER, 8' left of centerline, 580' MSL.

Trees beginning 1230' from DER, 132' right of centerline, up to 583' MSL.

Trees beginning 1356' from DER, 95' left of centerline, up to 583' MSL.

Tree 1592' from DER, 109' left of centerline, 596' MSL.

Tree 1791' from DER, 91' right of centerline, 587' MSL.

Rwy 23, tree 285' from DER, 518' left of centerline, 579' MSL.

Pole 722' from DER, 481' right of centerline, 36' AGL/565' MSL.

Tree 902' from DER, 673' right of centerline, 568' MSL.

Rwy 35, trees beginning 164' from DER, 205' right of centerline, up to 581' MSL.

Terrain 178' from DER, 486' left of centerline, 560' MSL.

Fence and vehicles on road beginning 892' from DER, crossing extended runway centerline, up to 11' AGL/575' MSL.

Tree 986' from DER, 189' left of centerline, 573' MSL.

Pole 1081' from DER, 584' left of centerline, 41' AGL/608' MSL.

CON'T

TAKEOFF MINIMUMS, (OBSTACLE) DEPARTURE PROCEDURES, AND DIVERSE VECTOR AREA (RADAR VECTORS)

23278

SC-1

TAKEOFF MINIMUMS, (OBSTACLE) DEPARTURE PROCEDURES, AND DIVERSE VECTOR AREA (RADAR VECTORS)

23278

NORTH LITTLE ROCK, AR (CON'T)

NORTH LITTLE ROCK MUNI (ORK) (CON'T)

- Rwy 35 (CON'T)**, tree 1490' from DER, 634' left of centerline, 627' MSL.
Trees and pole beginning 1541' from DER, 3' left of centerline, up to 632' MSL.
Tree 1599' from DER, 251' right of centerline, 597' MSL.
Tree 1750' from DER, 204' right of centerline, 599' MSL.

OKLAHOMA CITY, OK

CLARENCE E PAGE MUNI (RCE)

TAKEOFF MINIMUMS AND (OBSTACLE) DEPARTURE PROCEDURES

ORIG 28SEP06 (06271) (FAA)

TAKEOFF OBSTACLE NOTES:

- Rwy 17R**, multiple trees beginning 43' from DER, 331' right of centerline, 15' AGL/1348' MSL.
Multiple trees beginning 260' from DER, 345' left of centerline, 37' AGL/1366' MSL.
Rwy 35L, bush 90' from DER, 482' left of centerline, 8' AGL/1358' MSL.

SUNDANCE (HSD)

TAKEOFF MINIMUMS AND (OBSTACLE) DEPARTURE PROCEDURES

AMDT 2 12OCT17 (17285) (FAA)

DEPARTURE PROCEDURE:

- Rwy 18**, climb heading 174° to 1700 before proceeding on course.

TAKEOFF OBSTACLE NOTES:

- Rwy 18**, tree 133' from DER, 275' left of centerline, 1217' MSL.
Tree 206' from DER, 534' left of centerline, 1224' MSL.
Building 441' from DER, 472' left of centerline, 33' AGL/1215' MSL.
Tank 759' from DER, 545' right of centerline, 15' AGL/1212' MSL.
Tree 1553' from DER, 273' left of centerline, 1238' MSL.
T-L tower 4131' from DER, 562' left of centerline, 105' AGL/1334' MSL.
T-L tower 4807' from DER, 107' right of centerline, 109' AGL/1341' MSL.
Rwy 36, tree 131' from DER, 499' left of centerline, 1187' MSL.

WILEY POST (PWA)

TAKEOFF MINIMUMS AND (OBSTACLE) DEPARTURE PROCEDURES

AMDT 5 18SEP14 (14261) (FAA)

TAKEOFF MINIMUMS:

- Rwy 17L**, 300-1¼ or std. w/min. climb of 307' per NM to 1600.

DEPARTURE PROCEDURE:

- Rwy 13**, climb heading 130° to 2300 before turning left.
Rwys 35L, 35R, climb heading 355° to 1900 before turning right.

TAKEOFF OBSTACLE NOTES:

- Rwy 13**, hangar 467' from DER, 466' left of centerline, 19' AGL/1316' MSL.
Hangar 1349' from DER, 602' right of centerline, 35' AGL/1334' MSL.
Rwy 17L, trees beginning 1292' from DER, 371' right of centerline, up to 67' AGL/1348' MSL.
Tank 4592' from DER, 1222' left of centerline, 148' AGL/1478' MSL.
Tank 1 NM from DER, 1387' left of centerline, 144' AGL/1467' MSL.
Rwy 17R, pole 344' from DER, 422' left of centerline, 20' AGL/1305' MSL.
Rwy 35L, trees beginning 143' from DER, 516' left of centerline, up to 50' AGL/1321' MSL.
Spire 2441' from DER, 901' left of centerline, 86' AGL/1366' MSL.

WILL ROGERS WORLD (OKC)

TAKEOFF MINIMUMS AND (OBSTACLE) DEPARTURE PROCEDURES

AMDT 2 24JUL14 (14205) (FAA)

TAKEOFF OBSTACLE NOTES:

- Rwy 35L**, post 48' from DER, 495' left of centerline, 8' AGL/1287' MSL.
Rwy 36, obstruction light on windsock 674' from DER, 152' left of centerline, 25' AGL/1295' MSL.

OKMULGEE, OK

OKMULGEE RGNL/PAUL AND BETTY ABBOTT FLD (OKM)

TAKEOFF MINIMUMS AND (OBSTACLE) DEPARTURE PROCEDURES

AMDT 1 25OCT07 (22363) (FAA)

DEPARTURE PROCEDURE:

- Rwy 36**, climb heading 356° to 1600 before proceeding on course.

TAKEOFF OBSTACLE NOTES:

- Rwy 18**, multiple trees beginning 1303' from DER, 69' left of centerline, up to 100' AGL/779' MSL.
Multiple trees beginning 1699' from DER, 12' right of centerline, up to 100' AGL 779' MSL.

TAKEOFF MINIMUMS, (OBSTACLE) DEPARTURE PROCEDURES, AND DIVERSE VECTOR AREA (RADAR VECTORS)

23278

SC-1

TAKEOFF MINIMUMS, (OBSTACLE) DEPARTURE PROCEDURES, AND DIVERSE VECTOR AREA (RADAR VECTORS)

23278

OSCEOLA, AR

OSCEOLA MUNI (7M4)

TAKEOFF MINIMUMS AND (OBSTACLE) DEPARTURE PROCEDURES

AMDT 1 05NOV98 (98309) (FAA)

TAKEOFF MINIMUMS:

Rwy 1, 300-1.

TAKEOFF OBSTACLE NOTES:

Rwy 1, 180' AGL antenna 3003' from DER, 20' right of centerline.

OZARK, AR

OZARK/FRANKLIN COUNTY (7M5)

TAKEOFF MINIMUMS AND (OBSTACLE) DEPARTURE PROCEDURES

AMDT 2 03JUN10 (21336) (FAA)

TAKEOFF MINIMUMS:

Rwy 4, 400-1½ or std. w/min. climb of 492' per NM to 1200.**Rwy 22**, std. w/min. climb of 245' per NM to 1400, or 900-2½ for climb in visual conditions.

DEPARTURE PROCEDURE:

Rwy 4, climbing right turn to 3000 via FSM R-064 to FSM VORTAC before proceeding on course.**Rwy 22**, climbing right turn to 3000 via FSM R-064 to FSM VORTAC before proceeding on course, or for climb in visual conditions cross Ozark/Franklin County airport southwest bound at or above 1400 then climb to 3000 via FSM R-064 to FSM VORTAC before proceeding on course.

TAKEOFF OBSTACLE NOTES:

Rwy 4, tower 6713' from DER, 470' left of centerline, 995' MSL/205' AGL. Multiple trees and terrain beginning 27' from DER, 5' right of centerline, up to 50' AGL/849' MSL.

Multiple trees and terrain beginning 42' from DER, 87' left of centerline, up to 50' AGL/909' MSL.

Tank 582' from DER, 521' left of centerline, 13' AGL/678' MSL.

Tower 57' from DER, 404' right of centerline, 34' AGL/687' MSL.

Rwy 22, multiple trees beginning 159' from DER, 59' right of centerline, up to 50' AGL/949' MSL.

Multiple trees beginning 154' from DER, 59' left of centerline, up to 50' AGL/909' MSL.

PARAGOULD, AR

KIRK FLD (PGR)

TAKEOFF MINIMUMS AND (OBSTACLE) DEPARTURE PROCEDURES

ORIG 19FEB04 (21280) (FAA)

TAKEOFF MINIMUMS:

Rwy 4, 300-1 or std. w/min. climb of 333' per NM to 600.**Rwys 8, 26**, NA-unsurveyed turf runways.**Rwy 22**, 200-1.

TAKEOFF OBSTACLE NOTES:

Rwy 4, tank 5070' from DER, 883' right of centerline, 190' AGL/470' MSL.

Road 1285' from DER, on centerline, 289' MSL.

Sign 1506' from DER, 135' right of centerline, 50' AGL/331' MSL.

Rwy 22, sign 311' from DER, 285' right of centerline, 30' AGL/325' MSL.

Road 300' from DER, on centerline, 295' MSL.

PERRY, OK

PERRY MUNI (F22)

TAKEOFF MINIMUMS AND (OBSTACLE) DEPARTURE PROCEDURES

ORIG 18NOV10 (10322) (FAA)

TAKEOFF OBSTACLE NOTES:

Rwy 17, vehicle on road 735' from DER, 680' right of centerline, up to 15' AGL/1023' MSL.

Vehicle on road 721' from DER, 4' left of centerline, up to 15' AGL/1023' MSL.

Trees beginning 243' from DER, 180' right of centerline, up to 100' AGL/1149' MSL.

Trees beginning 786' from DER, 201' left of centerline, up to 100' AGL/1149' MSL.

Rwy 35, trees beginning 101' from DER, 297' left of centerline, up to 26' AGL/996' MSL.

PINE BLUFF, AR

PINE BLUFF RGNL/GRIDER FLD (PBF)

TAKEOFF MINIMUMS AND (OBSTACLE) DEPARTURE PROCEDURES

ORIG-A 01FEB18 (21252) (FAA)

TAKEOFF OBSTACLE NOTES:

Rwy 18, trees beginning 145' from DER, 259' left of centerline, up to 27' AGL/224' MSL.

Trees beginning 223' from DER, 503' right of centerline, up to 92' AGL/289' MSL.

Rwy 36, trees beginning 2187' from DER, 323' left of centerline, up to 92' AGL/289' MSL.

Tree 2333' from DER, 252' right of centerline, 66' AGL/263' MSL.

TAKEOFF MINIMUMS, (OBSTACLE) DEPARTURE PROCEDURES, AND DIVERSE VECTOR AREA (RADAR VECTORS)

23278

SC-1

TAKEOFF MINIMUMS, (OBSTACLE) DEPARTURE PROCEDURES, AND DIVERSE VECTOR AREA (RADAR VECTORS)

23278

POCAHONTAS, AR

POCAHONTAS MUNI (M70)

TAKEOFF MINIMUMS AND (OBSTACLE) DEPARTURE PROCEDURES

AMDT 1 13SEP18 (18256) (FAA)

DEPARTURE PROCEDURE:

Rwy 36, climb heading 002° to 1000 before turning left.

TAKEOFF OBSTACLE NOTES:

Rwy 18, tree, building and vehicles on road beginning 78' from DER, 272' left of centerline, up to 20' AGL/288' MSL.

Pole 265' from DER, 538' left of centerline, 36' AGL/303' MSL.

Tree and pole beginning 288' from DER, 312' left of centerline, up to 40' AGL/308' MSL.

Tree and poles beginning 364' from DER, 306' left of centerline, up to 46' AGL/314' MSL.

Pole 438' from DER, 432' right of centerline, 31' AGL/301' MSL.

Poles beginning 440' from DER, 313' right of centerline, up to 33' AGL/303' MSL.

Building 707' from DER, 480' left of centerline, 55' AGL/321' MSL.

Trees and poles beginning 1082' from DER, 324' right of centerline, up to 58' AGL/327' MSL.

Tree 1323' from DER, 610' left of centerline, 64' AGL/329' MSL.

Rwy 36, vehicle on road 2' from DER, 435' left of centerline, 284' MSL.

Pole 157' from DER, 501' left of centerline, 26' AGL/297' MSL.

Poles, vehicle on road and tree beginning 179' from DER, 444' left of centerline, up to 31' AGL/301' MSL.

Vehicle on road 203' from DER, 444' right of centerline, 285' MSL.

Poles beginning 204' from DER, 515' right of centerline, up to 23' AGL/298' MSL.

Trees beginning 449' from DER, 295' left of centerline, up to 57' AGL/319' MSL.

Tree 1065' from DER, 749' left of centerline, 85' AGL/342' MSL.

Tree 2007' from DER, 832' right of centerline, 75' AGL/340' MSL.

Tree 2523' from DER, 1172' right of centerline, 88' AGL/347' MSL.

Tree 2997' from DER, 40' right of centerline, 98' AGL/356' MSL.

Tree 3356' from DER, 1147' right of centerline, 101' AGL/360' MSL.

PONCA CITY, OK

PONCA CITY RGNL (PNC)

TAKEOFF MINIMUMS AND (OBSTACLE) DEPARTURE PROCEDURES

ORIG 20DEC07 (07354) (FAA)

TAKEOFF OBSTACLE NOTES:

Rwy 17, multiple buildings, poles, and antenna beginning 195' from DER, 303' right of centerline, up to 81' AGL/1071' MSL.

Trees and pole 1304' from DER, from 400' left of centerline, 70' AGL/1061' MSL.

Rwy 35, antenna on building 10' from DER, 437' right of centerline, 13' AGL/1013' MSL.

Trees 1475' from DER, 350' right of centerline 50' AGL/1030' MSL.

POTEAU, OK

ROBERT S KERR (RKR)

TAKEOFF MINIMUMS AND (OBSTACLE) DEPARTURE PROCEDURES

AMDT 4A 20JUN19 (21112) (FAA)

TAKEOFF MINIMUMS:

NOTE: Rwy 36 cross DER at or above 16' AGL/461' MSL.

DEPARTURE PROCEDURE:

Rwy 18, climb runway heading to 2500 before turning on course.

Rwy 36, climb runway heading to 2800 before turning on course.

TAKEOFF OBSTACLE NOTES:

Rwy 18, lighting beginning 2' from DER, 17' left of centerline, up to 4' AGL/452' MSL.

Lighting beginning 3' from DER, 17' right of centerline, up to 3' AGL/452' MSL.

Trees beginning 4' from DER, 281' right of centerline, up to 33' AGL/479' MSL.

Tree 82' from DER, 497' right of centerline, 45' AGL/492' MSL.

Tree, vehicles on road beginning 101' from DER, 298' left of centerline, up to 27' AGL/473' MSL.

Trees, vehicles on road beginning 155' from DER, 409' right of centerline, up to 58' AGL/503' MSL.

Trees, vehicles on road beginning 192' from DER, 285' left of centerline, up to 60' AGL/506' MSL.

Trees, vehicles on road beginning 316' from DER, 414' right of centerline, up to 59' AGL/510' MSL.

Rwy 36, terrain abeam DER, 22' left of centerline, 448' MSL.

Fence 2' from DER, 396' right of centerline, 5' AGL/449' MSL.

Vehicles on road, lighting, tree beginning 2' from DER, 12' right of centerline, up to 16' AGL/462' MSL.

Trees beginning 3' from DER, 263' left of centerline, up to 40' AGL/482' MSL.

Tree, vehicles on road 4A, beginning 23' from DER, 154' right of centerline, up to 61' AGL/506' MSL.

Trees, vehicles on road, terrain beginning 78' from DER, 273' left of centerline, up to 46' AGL/492' MSL.

Trees, vehicles on road beginning 204' from DER, 443' left of centerline, up to 50' AGL/493' MSL.

Trees, vehicles on road beginning 300' from DER, 437' left of centerline, up to 52' AGL/499' MSL.

Trees, vehicles on road beginning 308' from DER, 292' right of centerline, up to 65' AGL/508' MSL.

Trees, vehicles on road beginning 611' from DER, 396' left of centerline, up to 66' AGL/509' MSL.

Tree 1944' from DER, 457' right of centerline, 71' AGL/511' MSL.

Trees beginning 2049' from DER, 493' right of centerline, up to 77' AGL/517' MSL.

Trees beginning 2131' from DER, 593' left of centerline, up to 69' AGL/536' MSL.

Trees beginning 2432' from DER, 960' left of centerline, up to 54' AGL/538' MSL.

Tree 2720' from DER, 1042' left of centerline, 39' AGL/539' MSL.

Trees beginning 2721' from DER, 985' left of centerline, up to 33' AGL/558' MSL.

Tower 1 NM from DER, 1273' right of centerline, 75' AGL/612' MSL.

TAKEOFF MINIMUMS, (OBSTACLE) DEPARTURE PROCEDURES, AND DIVERSE VECTOR AREA (RADAR VECTORS)

23278

SC-1



23278

PRAGUE, OK**PRAGUE MUNI (O47)**

TAKEOFF MINIMUMS AND (OBSTACLE) DEPARTURE PROCEDURES

ORIG 29MAY14 (14149) (FAA)

DEPARTURE PROCEDURE:

Rwy 17, climb heading 177° to 1500 before turning left.

TAKEOFF OBSTACLE NOTES:

Rwy 17, vehicles on road beginning 129' from DER, 198' left of course, 15' AGL/1016' MSL.

Tree 2028' from DER, 411' left of centerline, up to 84' AGL/1063' MSL.

Vehicles on road beginning 124' from DER, 383' right of centerline, up to 15' AGL/1014' MSL.

Tree 212' from DER, 415' right of centerline, 50' AGL/1048' MSL.

Trees beginning 360' from DER, 104' right of centerline, up to 66' AGL/1055' MSL.

Rwy 35, trees, poles and vehicles on road, beginning 13' from DER, 155' left of centerline, up to 57' AGL/1089' MSL. Terrain

beginning 15' from DER, 241' right of centerline, up to 1047' MSL.

Trees, poles, fence, and vehicles on road, beginning 54' from DER, 164' right of centerline, up to 31' AGL/1074' MSL.

Trees, poles, and vehicles on road, beginning 381' from DER, left and right of centerline, up to 30' AGL/1074' MSL.

Trees, poles, buildings, and vehicles on road, beginning 780' from DER, left and right of centerline, up to 59' AGL/1095' MSL.

PRYOR, OK**MID-AMERICA INDUSTRIAL (H71)**

TAKEOFF MINIMUMS AND (OBSTACLE) DEPARTURE PROCEDURES

ORIG 22JUN95 (95173) (FAA)

DEPARTURE PROCEDURE:

Rwys 18, 36, climb to 1400 before turning on course.**ROGERS, AR****ROGERS EXEC - CARTER FLD (ROG)**

TAKEOFF MINIMUMS AND (OBSTACLE) DEPARTURE PROCEDURES

AMDT 1 24MAY18 (21112) (FAA)

TAKEOFF OBSTACLE NOTES:

Rwy 2, tree 33' from DER, 394' right of centerline, 1382' MSL.

Trees beginning 100' from DER, 431' left of centerline, up to 1385' MSL.

Rwy 20, tree 392' from DER, 504' right of centerline, 1380' MSL.

Pole 554' from DER, 613' left of centerline, 33' AGL/1392' MSL.

Trees, poles beginning 802' from DER, 80' left of centerline, up to 1423' MSL.

Tree 1114' from DER, 659' right of centerline, 1396' MSL.

Tree 2307' from DER, 733' right of centerline, 1418' MSL.

Tree 2576' from DER, 240' left of centerline, 1428' MSL.

Tower, transmission-line beginning 3085' from DER, 187' right of centerline, up to 122' AGL/1462' MSL.

Transmission-line 3513' from DER, 419' left of centerline, 95' AGL/1455' MSL.

Transmission-line 3573' from DER, 993' left of centerline, 103' AGL/1469' MSL.

RUSSELLVILLE, AR**RUSSELLVILLE RGNL (RUE)**

TAKEOFF MINIMUMS AND (OBSTACLE) DEPARTURE PROCEDURES

AMDT 2 05DEC19 (19339) (FAA)

TAKEOFF MINIMUMS:

Rwy 7, std. w/min. climb of 310' per NM to 1200 or 1200-3 for VCOA.**Rwy 25**, std. w/min. climb of 280' per NM to 2400 or 1200-3 for VCOA.

DEPARTURE PROCEDURE:

Rwy 7, climb on heading 085° to 1200 before proceeding on course.

VCOA:

Rwys 7, 25, obtain ATC approval for VCOA when requesting IFR clearance. Climb in visual conditions to cross Russellville Regional Airport at or above 1500 before proceeding on course.

TAKEOFF OBSTACLE NOTES:

Rwy 7, building, 2416' from DER, 250' left of centerline 50' AGL/520 MSL.

22 FEB 2024 to 21 MAR 2024

22 FEB 2024 to 21 MAR 2024

23278

SC-1

**TAKEOFF MINIMUMS, (OBSTACLE) DEPARTURE PROCEDURES, AND**

23278

DIVERSE VECTOR AREA (RADAR VECTORS)**SALLISAW, OK****SALLISAW MUNI (JSV)**

TAKEOFF MINIMUMS AND (OBSTACLE) DEPARTURE PROCEDURES

AMDT 2 10MAR11 (11069) (FAA)

TAKEOFF MINIMUMS:

Rwy 17, 400-2¼ or std. w/min. climb of 229' per NM to 1100.**Rwy 35**, 700-2¼ or std. w/min. climb of 450' per NM to 1400.

DEPARTURE PROCEDURE:

Rwy 17, climb heading 175° to 1100 before turning left.

TAKEOFF OBSTACLE NOTES:

Rwy 17, multiple trees beginning 197' from DER, 300' left of centerline, up to 89' AGL/598' MSL.

Multiple trees beginning 508' from DER, 178' right of centerline, 65' AGL/574' MSL.

Tree 2214' from DER, 180' right of centerline, 63' AGL/ 573' MSL.

Rwy 35, tower 2874' from DER, 719' left of centerline, 90' AGL/647' MSL.

Tower 3278' from DER, 1051' left of centerline, 80' AGL/649' MSL.

Tower 1.9 NM from DER, 331' right of centerline, 495' AGL/1161' MSL.

SAND SPRINGS, OK**WILLIAM R POGUE MUNI (OWP)**

TAKEOFF MINIMUMS AND (OBSTACLE) DEPARTURE PROCEDURES

AMDT 3 10MAR11 (11069) (FAA)

TAKEOFF MINIMUMS:

Rwy 35, 300-1½ or std. w/ min. climb of 253' per NM to 1300.

DEPARTURE PROCEDURE:

Rwy 17, climb heading 169° to 1900 before turning left.**Rwy 35**, climb heading 349° to 2300 before turning right.

TAKEOFF OBSTACLE NOTES:

Rwy 17, trees beginning 76' from DER, 235' left of centerline, up to 59' AGL/969' MSL.

Trees beginning 231' from DER, 346' right of centerline, up to 59' AGL/939' MSL.

SEARCY, AR**SEARCY MUNI (SRC)**

TAKEOFF MINIMUMS AND (OBSTACLE) DEPARTURE PROCEDURES

ORIG 20OCT11 (11293) (FAA)

TAKEOFF OBSTACLE NOTES:

Rwy 1, trees beginning 984' from DER, 327' left of centerline, up to 62' AGL/322' MSL.

Trees beginning 1202' from DER, 576' right of centerline, up to 53' AGL/303' MSL.

Rwy 19, trees beginning 1521' from DER, 629' left of centerline, up to 56' AGL/283' MSL.

Trees beginning 2638' from DER, 816' right of centerline, up to 98' AGL/331' MSL.

SEMINOLE, OK**SEMINOLE MUNI (SRE)**

TAKEOFF MINIMUMS AND (OBSTACLE) DEPARTURE PROCEDURES

ORIG 15MAR07 (07074) (FAA)

TAKEOFF OBSTACLE NOTES:

Rwy 16, power line 419' from DER, 403' left of centerline, 46' AGL/1025' MSL.**SHAWNEE, OK****SHAWNEE RGNL (SNL)**

TAKEOFF MINIMUMS AND (OBSTACLE) DEPARTURE PROCEDURES

ORIG 29JUL10 (10210) (FAA)

TAKEOFF OBSTACLE NOTES:

Rwy 17, multiple trees 620' from DER, 176' left of centerline, up to 41' AGL/1111' MSL.

Multiple light poles 1408' from DER, 650' left of centerline, up to 39' AGL/1109' MSL.

Multiple trees 165' from DER, 85' right of centerline, up to 43' AGL/1103' MSL.

Rwy 35, tree 93' from DER, 499' left of centerline, 15' AGL/1075' MSL.**SHERIDAN, AR****SHERIDAN-GRANT COUNTY RGNL (9M8)**

TAKEOFF MINIMUMS AND (OBSTACLE) DEPARTURE PROCEDURES

ORIG 10DEC15 (22083) (FAA)

DEPARTURE PROCEDURE:

Rwy 1, Climb heading 012° to 2400 before turning east.**Rwy 19**, Climb heading 192° to 800 before turning north.

TAKEOFF OBSTACLE NOTES:

Rwy 1, trees left and right of centerline beginning 9' from DER, up to 112' AGL/354' MSL.

Vehicle on road crossing right to left beginning 113' from DER, 15' AGL/251 MSL.

Rwy 19, trees left and right of centerline beginning 2' from DER, 5' right of centerline, up to 109' AGL/332' MSL.

Ground beginning 42' from DER, 248' left of centerline, up to 232' MSL.

Building 126' from DER, 424' left of centerline, 18' AGL/250' MSL.

CON'T

**TAKEOFF MINIMUMS, (OBSTACLE) DEPARTURE PROCEDURES, AND**

23278

DIVERSE VECTOR AREA (RADAR VECTORS)

TAKEOFF MINIMUMS, (OBSTACLE) DEPARTURE PROCEDURES, AND DIVERSE VECTOR AREA (RADAR VECTORS)

23278

SHERIDAN, AR (CON'T)

SHERIDAN-GRANT COUNTY RGNL (9M8) (CON'T)

Rwy 19 (CON'T), poles beginning 261' from DER, 218' left of centerline, up to 35' AGL/266' MSL.

Tower 695' from DER, 375' left of centerline, 21' AGL/251' MSL.

Transmission lines beginning 1318' from DER, 182' left of centerline, up to 32' AGL/264' MSL.

SILOAM SPRINGS, AR

SMITH FIELD (SLG)

TAKEOFF MINIMUMS AND (OBSTACLE) DEPARTURE PROCEDURES

ORIG 25OCT07 (07298) (FAA)

TAKEOFF OBSTACLE NOTES:

Rwy 18, light pole 1320' from DER, 358' right of centerline, 31' AGL/ 1209' MSL.

Trees 795' from DER, 354' left of centerline, up to 25' AGL/ 1197' MSL.

Trees 1272' from DER, 340' right of centerline, up to 34' AGL/1212' MSL.

Rwy 36, power pole 1185' from DER, 567' right of centerline, 31' AGL/1223' MSL.

Trees 528' from DER, 424' left of centerline, up to 54' AGL/1241' MSL.

Trees 532' from DER, 354' right of centerline, up to 39' AGL/1232' MSL.

SPRINGDALE, AR

SPRINGDALE MUNI (ASG)

TAKEOFF MINIMUMS AND (OBSTACLE) DEPARTURE PROCEDURES

AMDT 5 18NOV10 (10322) (FAA)

TAKEOFF MINIMUMS:

Rwy 36, 400-2½ or std. w/min. climb of 332' per NM to 1900.

DEPARTURE PROCEDURE:

Rwy 36, Climb heading 003° to 2000 before turning.

TAKEOFF OBSTACLE NOTES:

Rwy 18, trees and poles beginning 166' from DER, 242' left of centerline, up to 56' AGL/1395' MSL.

Trees beginning 42' from DER, 374' right of centerline, up to 69' AGL/1408' MSL.

Rwy 36, trees, tower, fence, and road beginning 296' from DER, 191' left of centerline, up to 44' AGL/1404' MSL. Poles, trees, and building beginning 354' from DER, 324' right of centerline, up to 59' AGL/1418' MSL.

STIGLER, OK

STIGLER RGNL (GZL)

TAKEOFF MINIMUMS AND (OBSTACLE) DEPARTURE PROCEDURES

AMDT 1 24JUL14 (14205) (FAA)

TAKEOFF MINIMUMS:

Rwy 17, 400-2½ or std. w/min. climb of 210' per NM to 1100.

Rwy 35, NA - Obstacles.

TAKEOFF OBSTACLE NOTES:

Rwy 17, trees beginning 189' from DER, 229' right of centerline, up to 52' AGL/651' MSL.

Tower 2 NM from centerline, 2399' right of centerline, 296' AGL/913' MSL.

STILLWATER, OK

STILLWATER RGNL (SWO)

TAKEOFF MINIMUMS AND (OBSTACLE) DEPARTURE PROCEDURES

ORIG 20OCT11 (21112) (FAA)

DEPARTURE PROCEDURE:

Rwy 17, climb heading 174° to 1600 before turning right.

Rwy 22, climb heading 220° to 2500 before turning right.

TAKEOFF OBSTACLE NOTES:

Rwy 4, fence 191' from DER, 271' left of centerline, 11' AGL/991' MSL.

Tree 857' from DER, 545' left of centerline, 30' AGL/1 020' MSL.

Tree 498' from DER, 331' right of centerline, 26' AGL/1 006' MSL.

Rwy 17, building and trees beginning 1075' from DER, from 540' left of centerline, up to 60' AGL/1019' MSL.

Rwy 22, trees beginning 1158' from DER, 770' left of centerline, up to 60' AGL/1029' MSL.

Rwy 35, trees beginning 94' from DER, 229' left of centerline, up to 60' AGL/1059' MSL.

Trees beginning 782' from DER, 669' right of centerline, up to 60' AGL/1039' MSL.

Plant 1688' from DER, 729' right of centerline, 79' AGL/1059' MSL.

STUTTGART, AR

STUTTGART MUNI CARL HUMPHREY FIELD (SGT)

TAKEOFF MINIMUMS AND (OBSTACLE) DEPARTURE PROCEDURES

ORIG-A 22JUN17 (17173) (FAA)

TAKEOFF OBSTACLE NOTES:

Rwy 18, tree 108' from DER, 286' right of centerline, up to 9' AGL/227' MSL.

Rwy 27, tree 188' from DER, 152' left of centerline, 7' AGL/227' MSL.

TAKEOFF MINIMUMS, (OBSTACLE) DEPARTURE PROCEDURES, AND DIVERSE VECTOR AREA (RADAR VECTORS)

23278

SC-1



23278

TAKEOFF MINIMUMS, (OBSTACLE) DEPARTURE PROCEDURES, AND DIVERSE VECTOR AREA (RADAR VECTORS)



TAHLEQUAH, OK

TAHLEQUAH MUNI (TQH)

TAKEOFF MINIMUMS AND (OBSTACLE) DEPARTURE PROCEDURES

AMDT 1 05JUN08 (08157) (FAA)

TAKEOFF MINIMUMS:

Rwy 35, 300-1% or std. w/ min. climb of 345' per NM to 1200.

TAKEOFF OBSTACLE NOTES:

Rwy 17, trees beginning 80' from DER, 16' right of centerline, up to 60' AGL/911' MSL.

Trees and poles beginning 139' from DER, 337' left of centerline, up to 34' AGL/855' MSL.

Light 1042' from DER, 403' left of centerline, 29' AGL/878' MSL.

Rwy 35, poles and trees beginning 23' from DER, 42' left of centerline, up to 56' AGL/1075' MSL.

Poles and trees beginning 1334' from DER, 29' right of centerline, up to 40' AGL/1058' MSL.

Building 4492' from DER, 889' left centerline, 24' AGL/1024' MSL.

TEXARKANA, AR

TEXARKANA RGNL-WEBB FLD (TXK)

TAKEOFF MINIMUMS AND (OBSTACLE) DEPARTURE PROCEDURES

AMDT 4A 11AUG22 (22223) (FAA)

TAKEOFF MINIMUMS:

Rwy 22, 300-1% or std. w/min. climb of 220' per NM to 600, or alternatively, with std. takeoff minimums and a normal 200' per NM climb gradient, takeoff must occur no later than 1600' prior to DER.

TAKEOFF OBSTACLE NOTES:

Rwy 4, multiple trees 881' from DER, 677' left of centerline, 60' AGL/419' MSL.

Multiple trees 767' from DER, 621' right of centerline, 75' AGL/434' MSL.

Rwy 13, multiple trees 21' from DER, 372' left of centerline, 75' AGL/424' MSL.

Multiple trees 1819' from DER, 133' left of centerline, 99' AGL/438' MSL.

Multiple trees beginning 237' from DER, 344' right of centerline, 98' AGL/457' MSL.

Rwy 22, antenna tower 1 NM from DER, 2016' left of centerline, 170' AGL/517' MSL.

Rwy 31, vehicle on road 346' from DER, on centerline, 15' AGL/391' MSL.

Multiple trees 535' from departure end of runway, 124' left of centerline, 60' AGL/391' MSL.

Multiple trees beginning 454' from DER, 349' right of centerline, 70' AGL/429' MSL.

Multiple trees 1962' from DER, 195' left of centerline, 60' AGL/429' MSL.

THOMAS, OK

THOMAS MUNI (104)

TAKEOFF MINIMUMS AND (OBSTACLE) DEPARTURE PROCEDURES

ORIG 30APR15 (15120) (FAA)

TAKEOFF MINIMUMS:

Rwy 35, 400-1% or std. w/min. climb of 335' per NM to 2300.

DEPARTURE PROCEDURE:

Rwy 35, climb heading 355° to 2300 before turning left.

TAKEOFF OBSTACLE NOTES:

Rwy 17, vehicles on roadway beginning 12' from DER, 470' right of centerline, up to 15' AGL/1757' MSL.

Trees, poles, and buildings beginning 65' from DER, 460' right of centerline, up to 35' AGL/1778' MSL.

Fence beginning 192' from DER, 195' left of centerline, up to 9' AGL/1739' MSL.

Rwy 35, vehicles on roadway beginning 28' from DER, 458' left of centerline, up to 15' AGL/1747' MSL.

Building, pole, and signs beginning 15' from DER, 404 left of centerline, up to 34' AGL/1765' MSL.

Vehicles on roadway beginning 337' from DER, left and right of centerline, up to 15' AGL/1750' MSL.

Tree 2044' from DER, 950' left of centerline, 62' AGL/1794' MSL.

TINKER AFB (KTIK)

OKLAHOMA CITY, OK

TAKEOFF MINIMUMS AND (OBSTACLE) DEPARTURE PROCEDURES

AMDT 2 29DEC22 (22363) (USAF)

DEPARTURE PROCEDURE:

Rwy 31, climb on hdg between 010° CW to 128° from DER.

Rwy 36, climb on hdg between 357° CW to 177° from DER.

TAKEOFF OBSTACLE NOTES:

Rwy 13, aerial cable 1389' from DER, 845' left of centerline, 38' AGL/1331' MSL.

Twr 751' from DER, 694' left of centerline, 18' AGL/1308' MSL.

Terrain 0' from DER, 500' left of centerline, 1277' MSL.

Rwy 18, terrain 0' from DER, 500' left of centerline, 1297' MSL.

22 FEB 2024 to 21 MAR 2024

22 FEB 2024 to 21 MAR 2024



23278

TAKEOFF MINIMUMS, (OBSTACLE) DEPARTURE PROCEDURES, AND DIVERSE VECTOR AREA (RADAR VECTORS)



SC-1

TAKEOFF MINIMUMS, (OBSTACLE) DEPARTURE PROCEDURES, AND DIVERSE VECTOR AREA (RADAR VECTORS)

23278

TULSA, OK

TULSA INTL (TUL)

TAKEOFF MINIMUMS AND (OBSTACLE) DEPARTURE PROCEDURES

AMDT 1B 07NOV19 (19311) (FAA)

DEPARTURE PROCEDURE:

Rwy 26, climb on a heading between 292° CW to 086° from DER, or min. climb of 222' per NM to 2900 for headings 087° through 291°.

TAKEOFF OBSTACLE NOTES:

Rwy 8, sign 131' from DER, 466' right of centerline, 8' AGL/637' MSL.

Tree 825' from DER, 713' left of centerline, 660' MSL.

Building, pole beginning 1030' from DER, 690' right of centerline, up to 48' AGL/677' MSL.

Transmission lines beginning 1608' from DER, crossing left and right of centerline, up to 679' MSL.

Rwy 18L, tree 1880' from DER, 905' left of centerline, 74' AGL/693' MSL.

Rwy 18R, vehicle on road 200' from DER, 419' right of centerline, 15' AGL/687' MSL.

Ant on building 549' from DER, 447' left of centerline, 22' AGL/692' MSL.

Building 411' from DER, 574' right of centerline, 39' AGL/699' MSL.

Sign 1151' from DER, 757' right of centerline, 46' AGL/720' MSL.

Building 2847' from DER, 690' right of centerline, 118' AGL/788' MSL.

Rwy 26, antenna and buildings beginning 1031' from DER, 745' left of centerline, up to 51' AGL/707' MSL.

Tree 1544' from DER, 425' left of centerline, 53' AGL/713' MSL.

Rwy 36L, trees 726' from DER, 608' right of centerline, 69' AGL/659' MSL.

Trees 822' from DER, 596' left of centerline, 82' AGL/672' MSL.

Rwy 36R, lights and NAVAID 2' from DER, on centerline, 1' AGL/627' MSL.

Trees beginning 1630' from DER, 470' left of centerline, up to 84' AGL/674' MSL.

TULSA RIVERSIDE (RVS)

TAKEOFF MINIMUMS AND (OBSTACLE) DEPARTURE PROCEDURES

AMDT 8 20JUN19 (22027) (FAA)

TAKEOFF MINIMUMS:

Rwy 13, 300-3 or std. w/min. climb of 330' per NM to 1000.

Rwy 31, 400-2¼, or 300-1 w/min. climb of 315' per NM to 1100, or std. w/min. climb of 610' per NM to 900, or 1100-3 for VCOA.

DEPARTURE PROCEDURE:

Rwys 1L, 1R, climb heading 010° to 1500, before proceeding on course.

Rwy 13, climb heading 130° to 1500, before proceeding on course.

Rwys 19L, 19R, climb heading 190° to 1500, before proceeding on course.

Rwy 31, climb heading 295° to 1500, before proceeding on course.

VCOA:

Rwy 31, obtain ATC approval for VCOA when requesting IFR clearance. Climb in visual conditions to cross Tulsa Riverside airport at or above 1600 before proceeding on course.

TAKEOFF OBSTACLE NOTES:

Rwy 1L, railroad 397' from DER, 594' right of centerline, 23' AGL/652' MSL.

Tree 1492' from DER, 626' right of centerline, 80' AGL/700' MSL.

Rwy 1R, railroad 162' from DER, 226' right of centerline, 646' MSL.

Tree 249' from DER, 236' right of centerline, 669' MSL.

Pole and vehicle on road beginning 521' from DER, 116' right of centerline, up to 53' AGL/673' MSL.

Tree 1843' from DER, 73' left of centerline, 700' MSL.

Rwy 13, trees and building beginning 63' from DER, 101' right of centerline, up to 100' AGL/724' MSL.

Tree 1960' from DER, 91' left of centerline, 679' MSL.

Tree 2437' from DER, 31' left of centerline, 699' MSL.

Pole 5849' from DER, 1921' left of centerline, up to 144' AGL/765' MSL.

Pole 5909' from DER, 1901' left of centerline, up to 150' AGL/771' MSL.

Tree and poles beginning 5961' from DER, 1786' left of centerline, up to 168' AGL/788' MSL.

Rwy 19L, vehicle on road 516' from DER, 282' left of centerline, 15' AGL/644' MSL.

Tree 790' from DER, 310' left of centerline, 665' MSL.

Tree 1378' from DER, 457' left of centerline, 683' MSL.

Rwy 19R, vehicle on road 333' from DER, 563' left of centerline, 15' AGL/644' MSL.

Tree 2247' from DER, 1020' left of centerline, 685' MSL.

Rwy 31, building 507' from DER, 344' right of centerline, 19' AGL/640' MSL.

Tree 1372' from DER, 264' left of centerline, 679' MSL.

Tree 1598' from DER, 117' right of centerline, 682' MSL.

Tree 1614' from DER, 76' left of centerline, 683' MSL.

Tree 1745' from DER, 186' right of centerline, 688' MSL.

Tree 2160' from DER, 74' left of centerline, 721' MSL.

Tree and transmission lines beginning 2728' from DER, 310' left centerline, up to 786' MSL.

Transmission line 2732' from DER, 27' right of centerline, 92' AGL/728' MSL.

Transmission line 4655' from DER, 1747' left of centerline, 117' AGL/792' MSL.

Tree 1.3 NM from DER, 1223' right of centerline, 872' MSL.

Tank 1.3 NM from DER, 1768' left of centerline, AGL/918' MSL.

Tower, sign, tree beginning 1.4 NM from DER, 120' right of centerline, up to 84' AGL/914' MSL.

22 FEB 2024 to 21 MAR 2024

22 FEB 2024 to 21 MAR 2024

TAKEOFF MINIMUMS, (OBSTACLE) DEPARTURE PROCEDURES, AND DIVERSE VECTOR AREA (RADAR VECTORS)

23278

SC-1

TAKEOFF MINIMUMS, (OBSTACLE) DEPARTURE PROCEDURES, AND DIVERSE VECTOR AREA (RADAR VECTORS)

23278

VANCE AFB (KEND)

ENID, OK

TAKEOFF MINIMUMS AND (OBSTACLE) DEPARTURE PROCEDURES
AMDT 2 24MAR22 (22083) (USAF)

TAKEOFF OBSTACLE NOTES:

Rwy 17C, barrier (when raised) 146' into overrun, on centerline, 24' AGL/1321' MSL.

Rwy 17L, terrain 25' from DER, 500' right of centerline, 1286' MSL.

Terrain 31' from DER, 7' left of centerline, 1285' MSL.

T-1 aircraft on taxiway 204' from DER, 185' right of centerline, 14' AGL/1298' MSL.

T-1 aircraft on taxiway 383' from DER, 575' left of centerline, 14' AGL/1303' MSL.

Trees 2479' from DER, 1137' left of centerline, 70' AGL/1349' MSL.

Rwy 17R, barrier (when raised) 145' into overrun, on centerline, 24' AGL/1336' MSL.

Terrain abeam thld 500' left of centerline, 1308' MSL.

Rwy 35C, barrier (when raised) 140' into overrun, on centerline, 24' AGL/1301' MSL.

Rwy 35L, barrier (when raised) 142' into overrun, on centerline, 24' AGL/1303' MSL.

Vehicle on road 735' from DER, 603' right of centerline, 10' AGL/1273' MSL.

Rwy 35R, wind sensor 1885' from DER, 576' left of centerline, 33' AGL/1299' MSL.

Vehicle on road 145' from DER, 291' left of centerline, 10' AGL/1284' MSL.

T-1 aircraft on taxiway 212' from DER, 575' right of centerline, 14' AGL/1280' MSL.

VINITA, OK

VINITA MUNI (H04)

TAKEOFF MINIMUMS AND (OBSTACLE) DEPARTURE PROCEDURES

ORIG 15JUN23 (23166) (FAA)

DEPARTURE PROCEDURE:

Rwy 35, climb on heading 355° to 1200 before turning left.

TAKEOFF OBSTACLE NOTES:

Rwy 17, trees beginning 43' from DER, 209' right of centerline, up to 100' AGL/779' MSL.

Trees beginning 78' from DER, 414' left of centerline, up to 100' AGL/779' MSL.

Rwy 35, vehicle 22' from DER, 436' left of centerline, 15' AGL/704' MSL.

Trees beginning 411' from DER, 196' left of centerline, up to 100' AGL/779' MSL.

Trees beginning 1835' from DER, 651' right of centerline, up to 100' AGL/779' MSL.

WAGONER, OK

HEFNER-EASLEY (H68)

TAKEOFF MINIMUMS AND (OBSTACLE) DEPARTURE PROCEDURES

AMDT 1 03JAN19 (19003) (FAA)

TAKEOFF OBSTACLE NOTES:

Rwy 18, tree, terrain beginning 25' from DER, 131' right of centerline, up to 622' MSL.

Tree, vehicles on road, beginning 39' from DER, 186' left of centerline, up to 44' AGL/641' MSL.

Pole, terrain beginning 108' from DER, 146' right of centerline, up to 627' MSL.

Tree 187' from DER, 544' right of centerline, 62' AGL/657' MSL.

Tree, wind indicator, pole, terrain, vehicles on road, building beginning 260' from DER, 150' right of centerline, up to 60' AGL/659' MSL.

Tree, pole beginning 545' from DER, 232' right of centerline, up to 661' MSL.

Pole, tree beginning 691' from DER, 11' left of centerline, up to 647' MSL.

Tree, building beginning 874' from DER, 272' left of centerline, up to 651' MSL.

Trees beginning 922' from DER, 365' right of centerline, up to 79' AGL/672' MSL.

Tree, pole beginning 949' from DER, on centerline, up to 80' AGL/674' MSL.

Trees beginning 953' from DER, 2' left of centerline, up to 652' MSL.

Trees beginning 1315' from DER, 1' left of centerline, up to 653' MSL.

Trees beginning 2193' from DER, 139' left of centerline, up to 83' AGL/680' MSL.

Rwy 36, trees beginning 28' from DER, 248' right of centerline, up to 620' MSL.

Trees beginning 63' from DER, 363' left of centerline, up to 599' MSL.

Trees beginning 69' from DER, 221' right of centerline, up to 36' AGL/630' MSL.

Trees beginning 284' from DER, 1' right of centerline, up to 634' MSL.

Trees beginning 288' from DER, 260' left of centerline, up to 602' MSL.

Trees beginning 449' from DER, 230' left of centerline, up to 603' MSL.

WALNUT RIDGE, AR

WALNUT RIDGE RGNL (ARG)

TAKEOFF MINIMUMS AND (OBSTACLE) DEPARTURE PROCEDURES

ORIG 20OCT11 (11293) (FAA)

TAKEOFF OBSTACLE NOTES:

Rwy 4, tree 2675' from DER, 756' left of centerline, 78' AGL/349' MSL.

Rwy 18, vehicles on roadway 66' from DER, 487' left of centerline, up to 15' AGL/284' MSL.

Rwy 31, vehicles on roadway beginning 56' from DER, left and right of centerline, up to 15' AGL/291' MSL.

Rwy 36, trees beginning 123' from DER, left and right of centerline, up to 87' AGL/319' MSL.

Pole 192' from DER, 410' right of centerline, 50' AGL/321' MSL.

Vehicles on roadway beginning 460' from DER, left and right of centerline, up to 17' AGL/291' MSL.

TAKEOFF MINIMUMS, (OBSTACLE) DEPARTURE PROCEDURES, AND DIVERSE VECTOR AREA (RADAR VECTORS)

23278

SC-1

TAKEOFF MINIMUMS, (OBSTACLE) DEPARTURE PROCEDURES, AND DIVERSE VECTOR AREA (RADAR VECTORS)

23278

WARREN, AR

WARREN MUNI (3M9)

TAKEOFF MINIMUMS AND (OBSTACLE) DEPARTURE PROCEDURES

ORIG 22SEP11 (11265) (FAA)

TAKEOFF OBSTACLE NOTES:

Rwy 3, trees beginning at DER, 190' left and right of centerline, up to 100' AGL/335' MSL.

Vehicle on road, building, and hangar beginning 2' from DER, 192' right of centerline, up to 22' AGL/257' MSL.

Rwy 21, trees beginning at DER, 172' left and right of centerline, up to 100' AGL/297' MSL.

Terrain rising 115' from DER, 13' left and right of centerline, up to 210' MSL.

WATONGA, OK

WATONGA RGNL (JWG)

TAKEOFF MINIMUMS AND (OBSTACLE) DEPARTURE PROCEDURES

AMD T 1 25OCT07 (07298) (FAA)

TAKEOFF MINIMUMS:

Rwy 17, 400-2 or std. with a min. climb of 315' per NM to 2000.

TAKEOFF OBSTACLE NOTES:

Rwy 17, vehicle on road 165' from DER, 471' left of centerline, 15' AGL/1554' MSL.

Elevator 5609' from DER, 614' left of centerline, 177' AGL/1694' MSL.

Rwy 35, trees beginning 3318' from DER, 435' left of centerline, up to 100' AGL/1689' MSL.

Vehicle on road 284' from DER, 471' right of centerline, 15' AGL/1584' MSL.

WEATHERFORD, OK

WEATHERFORD STAFFORD (OJA)

TAKEOFF MINIMUMS AND (OBSTACLE) DEPARTURE PROCEDURES

AMD T 1 10MAY07 (22139) (FAA)

DEPARTURE PROCEDURE:

Rwy 17, climb via heading 188° to 2500 before proceeding on course.

TAKEOFF OBSTACLE NOTES:

Rwy 17, truck on road 682' from DER, crossing centerline, 17' AGL/1636' MSL.

Multiple trees beginning 2605' from DER, 652' right of centerline, up to 100' AGL/1699' MSL.

Rwy 35, tree 1421' from DER, 413' right of centerline, 40' AGL/1649' MSL.

WEST MEMPHIS, AR

WEST MEMPHIS MUNI (AWM)

TAKEOFF MINIMUMS AND (OBSTACLE) DEPARTURE PROCEDURES

AMD T 1 18MAY00 (00139) (FAA)

TAKEOFF OBSTACLE NOTES:

Rwy 17, 101' AGL trees 2155' from DER, 196' right of centerline.

WOODWARD, OK

WEST WOODWARD (WWR)

TAKEOFF MINIMUMS AND (OBSTACLE) DEPARTURE PROCEDURES

AMD T 2 14JUL22 (22195) (FAA)

TAKEOFF MINIMUMS:

Rwys 5, 23, NA-Environmental.

DEPARTURE PROCEDURE:

Rwy 17, climb on heading 172° to 3100 before turning left.

TAKEOFF OBSTACLE NOTES:

Rwy 17, fence 49' from DER, 300' right of centerline, 12' AGL/2192' MSL.

Rwy 35, tree 580' from DER, 333' right of centerline, 2178' MSL.

22 FEB 2024 to 21 MAR 2024

22 FEB 2024 to 21 MAR 2024

TAKEOFF MINIMUMS, (OBSTACLE) DEPARTURE PROCEDURES, AND DIVERSE VECTOR AREA (RADAR VECTORS)

23278

SC-1

VINTA THREE ARRIVAL
(VINTA.VINTA3) 02DEC21

(VINTA.VINTA3) 24025
VINTA THREE ARRIVAL

TULSA APP CON
119.1 360.825
RVS ATIS
126.5
TUL D-ATIS
124.9 377.2

BARTLESVILLE
117.9 BVO 
Chan 126

SPRINGFIELD
116.9 SGF 
Chan 116

TULSA
114.4 TUL 
Chan 91

N

TULSA INTL

TULSA RIVERSIDE

NOTE: Chart not to scale.

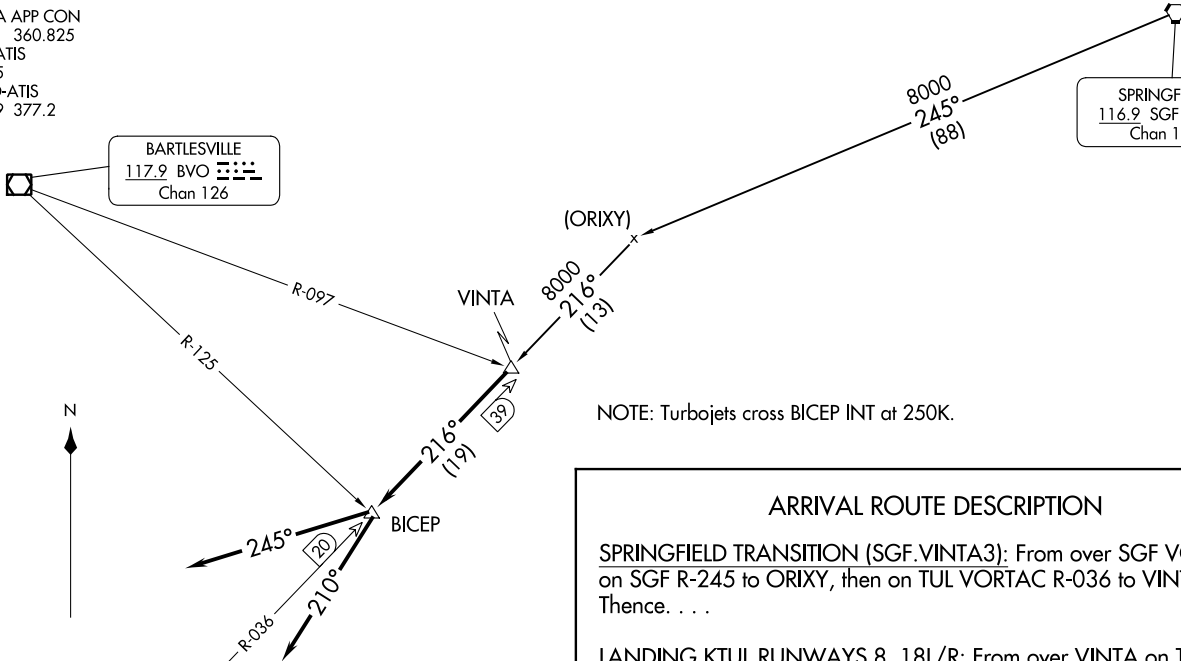

NOTE: Turbojets cross BICEP INT at 250K.

ARRIVAL ROUTE DESCRIPTION

SPRINGFIELD TRANSITION (SGF.VINTA3): From over SGF VORTAC on SGF R-245 to ORIXY, then on TUL VORTAC R-036 to VINTA. Thence. . .

LANDING KTUL RUNWAYS 8, 18L/R: From over VINTA on TUL VORTAC R-036 to BICEP. Depart BICEP heading 245°. Expect vectors to final approach course. Turbojets cross BICEP at 250K.

LANDING KTUL RUNWAYS 26, 36L/R: From over VINTA on TUL VORTAC R-036 to BICEP. Depart BICEP heading 210°. Expect vectors to final approach course. Turbojets cross BICEP at 250K.

LANDING KRVS: From over VINTA on TUL VORTAC R-036 to BICEP. Depart BICEP heading 210°. Expect vectors to final approach course.

AL-432 (FAA)

TULSA, OKLAHOMA

TULSA, OKLAHOMA